

ZyWALL USG 20/20W

Unified Security Gateway

User's Guide

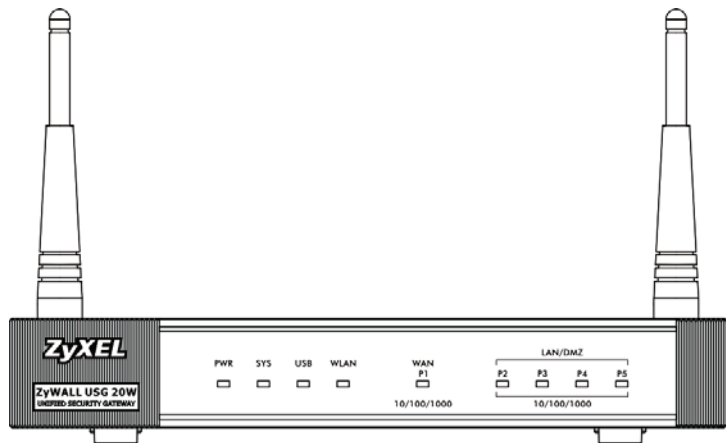
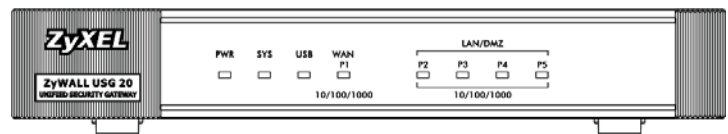

Default Login Details

LAN Port	P2, P3
IP Address	https://192.168.1.1
User Name	admin
Password	1234

Version 2.21
Edition 4, 4/2011

www.zyxel.com

ZyXEL

About This User's Guide

Intended Audience

This manual is intended for people who want to want to configure the ZyWALL using the Web Configurator.

How To Use This Guide

- Read [Chapter 1 on page 29](#) chapter for an overview of features available on the ZyWALL.
- Read [Chapter 3 on page 43](#) for web browser requirements and an introduction to the main components, icons and menus in the ZyWALL Web Configurator.
- Read [Chapter 4 on page 59](#) if you're using the installation wizard for first time setup and you want more detailed information than what the real time online help provides.
- Read [Chapter 5 on page 69](#) if you're using the quick setup wizards and you want more detailed information than what the real time online help provides.
- It is highly recommended you read [Chapter 6 on page 87](#) for detailed information on essential terms used in the ZyWALL, what prerequisites are needed to configure a feature and how to use that feature.
- It is highly recommended you read [Chapter 7 on page 107](#) for ZyWALL application examples.
- Subsequent chapters are arranged by menu item as defined in the Web Configurator. Read each chapter carefully for detailed information on that menu item.
- To find specific information in this guide, use the **Contents Overview**, the **Table of Contents**, the **Index**, or search the PDF file. E-mail techwriters@zyxel.com.tw if you cannot find the information you require.

Related Documentation

- Quick Start Guide

The Quick Start Guide is designed to show you how to make the ZyWALL hardware connections and access the Web Configurator wizards. (See the wizard real time help for information on configuring each screen.) It also contains a connection diagram and package contents list.

- CLI Reference Guide

The CLI Reference Guide explains how to use the Command-Line Interface (CLI) to configure the ZyWALL.

Note: It is recommended you use the Web Configurator to configure the ZyWALL.

- Web Configurator Online Help

Click the help icon in any screen for help in configuring that screen and supplementary information.

- ZyXEL Web Site

Please refer to www.zyxel.com for additional support documentation and product certifications.

User Guide Feedback

Help us help you. Send all User Guide-related comments, questions or suggestions for improvement to the following address, or use e-mail instead. Thank you!

The Technical Writing Team,
ZyXEL Communications Corp.,
6 Innovation Road II,
Science-Based Industrial Park,
Hsinchu, 300, Taiwan.

E-mail: techwriters@zyxel.com.tw

Need More Help?

More help is available at www.zyxel.com.

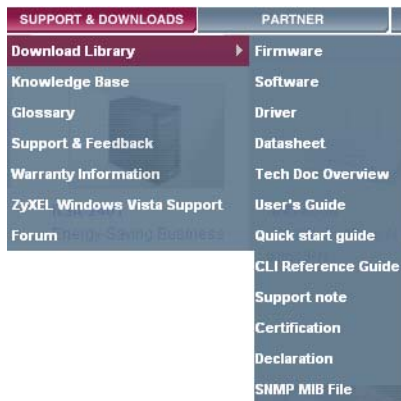

- Download Library

Search for the latest product updates and documentation from this link. Read the Tech Doc Overview to find out how to efficiently use the User Guide, Quick Start Guide and Command Line Interface Reference Guide in order to better understand how to use your product.

- Knowledge Base

If you have a specific question about your product, the answer may be here. This is a collection of answers to previously asked questions about ZyXEL products.

- Forum

This contains discussions on ZyXEL products. Learn from others who use ZyXEL products and share your experiences as well.

Customer Support

Should problems arise that cannot be solved by the methods listed above, you should contact your vendor. If you cannot contact your vendor, then contact a ZyXEL office for the region in which you bought the device.

See http://www.zyxel.com/web/contact_us.php for contact information. Please have the following information ready when you contact an office.

- Product model and serial number.
- Warranty Information.
- Date that you received your device.
- Brief description of the problem and the steps you took to solve it.

Disclaimer

Graphics in this book may differ slightly from the product due to differences in operating systems, operating system versions, or if you installed updated firmware/software for your device. Every effort has been made to ensure that the information in this manual is accurate.

Document Conventions

Warnings and Notes

These are how warnings and notes are shown in this User's Guide.

Warnings tell you about things that could harm you or your device.







Note: Notes tell you other important information (for example, other things you may need to configure or helpful tips) or recommendations.

Syntax Conventions

- The ZyWALL may be referred to as the "ZyWALL", the "device", the "system" or the "product" in this User's Guide.
- Product labels, screen names, field labels and field choices are all in **bold** font.
- A key stroke is denoted by square brackets and uppercase text, for example, [ENTER] means the "enter" or "return" key on your keyboard.
- "Enter" means for you to type one or more characters and then press the [ENTER] key. "Select" or "choose" means for you to use one of the predefined choices.
- A right angle bracket (>) within a screen name denotes a mouse click. For example, **Maintenance > Log > Log Setting** means you first click **Maintenance** in the navigation panel, then the **Log** sub menu and finally the **Log Setting** tab to get to that screen.
- Units of measurement may denote the "metric" value or the "scientific" value. For example, "k" for kilo may denote "1000" or "1024", "M" for mega may denote "1000000" or "1048576" and so on.
- "e.g.," is a shorthand for "for instance", and "i.e.," means "that is" or "in other words".

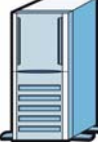
Icons Used in Figures

Figures in this User's Guide may use the following generic icons. The ZyWALL icon is not an exact representation of your device.

ZyWALL 	Computer 	Notebook computer 
Server 	Firewall 	Telephone 
Switch 	Router 	

Safety Warnings

- Do NOT use this product near water, for example, in a wet basement or near a swimming pool.
- Do NOT expose your device to dampness, dust or corrosive liquids.
- Do NOT store things on the device.
- Do NOT install, use, or service this device during a thunderstorm. There is a remote risk of electric shock from lightning.
- Connect ONLY suitable accessories to the device.
- Do NOT open the device or unit. Opening or removing covers can expose you to dangerous high voltage points or other risks. ONLY qualified service personnel should service or disassemble this device. Please contact your vendor for further information.
- Make sure to connect the cables to the correct ports.
- Place connecting cables carefully so that no one will step on them or stumble over them.
- Always disconnect all cables from this device before servicing or disassembling.
- Use ONLY an appropriate power adaptor or cord for your device. Connect it to the right supply voltage (for example, 110V AC in North America or 230V AC in Europe).
- Do NOT remove the plug and connect it to a power outlet by itself; always attach the plug to the power adaptor first before connecting it to a power outlet.
- Do NOT allow anything to rest on the power adaptor or cord and do NOT place the product where anyone can walk on the power adaptor or cord.
- Do NOT use the device if the power adaptor or cord is damaged as it might cause electrocution.
- If the power adaptor or cord is damaged, remove it from the device and the power source.
- Do NOT attempt to repair the power adaptor or cord. Contact your local vendor to order a new one.
- Do not use the device outside, and make sure all the connections are indoors. There is a remote risk of electric shock from lightning.
- CAUTION: RISK OF EXPLOSION IF BATTERY (on the motherboard) IS REPLACED BY AN INCORRECT TYPE. DISPOSE OF USED BATTERIES ACCORDING TO THE INSTRUCTIONS. Dispose them at the applicable collection point for the recycling of electrical and electronic equipment. For detailed information about recycling of this product, please contact your local city office, your household waste disposal service or the store where you purchased the product.
- Do NOT obstruct the device ventilation slots, as insufficient airflow may harm your device.
- Antenna Warning! This device meets ETSI and FCC certification requirements when using the included antenna(s). Only use the included antenna(s).
- If you wall mount your device, make sure that no electrical lines, gas or water pipes will be damaged.

Your product is marked with this symbol, which is known as the WEEE mark. WEEE stands for Waste Electrical and Electronic Equipment. It means that used electrical and electronic products should not be mixed with general waste. Used electrical and electronic equipment should be treated separately.



Contents Overview

User's Guide	27
Introducing the ZyWALL	29
Features and Applications	37
Web Configurator	43
Installation Setup Wizard	59
Quick Setup	69
Configuration Basics	87
Tutorials	107
Technical Reference	163
Dashboard	165
Monitor	177
Registration	211
Interfaces	217
Trunks	289
Policy and Static Routes	297
Routing Protocols	313
Zones	327
DDNS	331
NAT	337
HTTP Redirect	347
ALG	351
IP/MAC Binding	359
Authentication Policy	365
Firewall	373
IPSec VPN	391
SSL VPN	427
SSL User Screens	437
SSL User Application Screens	447
ZyWALL SecuExtender	449
Bandwidth Management	453
ADP	467
Content Filtering	487
Content Filter Reports	513
Anti-Spam	521
User/Group	539
Addresses	555
Services	561

Schedules	567
AAA Server	573
Authentication Method	583
Certificates	589
ISP Accounts	611
SSL Application	615
Endpoint Security	621
System	629
Log and Report	679
File Manager	693
Diagnostics	705
Packet Flow Explore	715
Reboot	723
Shutdown	725
Troubleshooting	727
Product Specifications	741

Table of Contents

About This User's Guide	3
Document Conventions.....	6
Safety Warnings.....	8
Contents Overview	9
Table of Contents.....	11
Part I: User's Guide.....	27
Chapter 1	
Introducing the ZyWALL	29
1.1 Overview and Key Default Settings	29
1.2 Wall-mounting	29
1.3 Front Panel	32
1.3.1 Front Panel LEDs	32
1.4 Management Overview	33
1.5 Starting and Stopping the ZyWALL	34
Chapter 2	
Features and Applications	37
2.1 Features	37
2.2 Applications	39
2.2.1 VPN Connectivity	39
2.2.2 SSL VPN Network Access	39
2.2.3 User-Aware Access Control	41
Chapter 3	
Web Configurator.....	43
3.1 Web Configurator Requirements	43
3.2 Web Configurator Access	43
3.3 Web Configurator Screens Overview	45
3.3.1 Title Bar	46
3.3.2 Navigation Panel	47
3.3.3 Main Window	52
3.3.4 Tables and Lists	54

Chapter 4	
Installation Setup Wizard	59
4.1 Installation Setup Wizard Screens	59
4.1.1 Internet Access Setup - WAN Interface	59
4.1.2 Internet Access: Ethernet	60
4.1.3 Internet Access: PPPoE	61
4.1.4 Internet Access: PPTP	63
4.1.5 ISP Parameters	63
4.1.6 Internet Access - Finish	65
4.2 Device Registration	65
Chapter 5	
Quick Setup	69
5.1 Quick Setup Overview	69
5.2 WAN Interface Quick Setup	70
5.2.1 Choose an Ethernet Interface	70
5.2.2 Select WAN Type	70
5.2.3 Configure WAN Settings	71
5.2.4 WAN and ISP Connection Settings	72
5.2.5 Quick Setup Interface Wizard: Summary	74
5.3 VPN Quick Setup	75
5.4 VPN Setup Wizard: Wizard Type	76
5.5 VPN Express Wizard - Scenario	77
5.5.1 VPN Express Wizard - Configuration	78
5.5.2 VPN Express Wizard - Summary	79
5.5.3 VPN Express Wizard - Finish	80
5.5.4 VPN Advanced Wizard - Scenario	81
5.5.5 VPN Advanced Wizard - Phase 1 Settings	82
5.5.6 VPN Advanced Wizard - Phase 2	83
5.5.7 VPN Advanced Wizard - Summary	85
5.5.8 VPN Advanced Wizard - Finish	86
Chapter 6	
Configuration Basics	87
6.1 Object-based Configuration	87
6.2 Zones, Interfaces, and Physical Ports	88
6.2.1 Interface Types	89
6.2.2 Default Interface and Zone Configuration	90
6.3 Terminology in the ZyWALL	91
6.4 Packet Flow	91
6.4.1 Routing Table Checking Flow	92
6.4.2 NAT Table Checking Flow	94
6.5 Feature Configuration Overview	95

6.5.1 Feature	95
6.5.2 Licensing Registration	96
6.5.3 Interface	96
6.5.4 Trunks	96
6.5.5 Policy Routes	96
6.5.6 Static Routes	98
6.5.7 Zones	98
6.5.8 DDNS	98
6.5.9 NAT	98
6.5.10 HTTP Redirect	99
6.5.11 ALG	100
6.5.12 Auth. Policy	100
6.5.13 Firewall	100
6.5.14 IPSec VPN	101
6.5.15 SSL VPN	101
6.5.16 Bandwidth Management	102
6.5.17 ADP	102
6.5.18 Content Filter	102
6.5.19 Anti-Spam	103
6.6 Objects	103
6.6.1 User/Group	104
6.7 System	105
6.7.1 DNS, WWW, SSH, TELNET, FTP, SNMP, Vantage CNM	105
6.7.2 Logs and Reports	105
6.7.3 File Manager	106
6.7.4 Diagnostics	106
6.7.5 Shutdown	106
Chapter 7	
Tutorials	107
7.1 How to Configure Interfaces, Port Roles, and Zones	107
7.1.1 Configure a WAN Ethernet Interface	108
7.1.2 Configure Port Roles	109
7.1.3 Configure the DMZ Interface for a Local Network	109
7.1.4 Configure Zones	110
7.2 How to Configure a Cellular Interface	111
7.3 How to Configure Load Balancing	113
7.3.1 Set Up Available Bandwidth on Ethernet Interfaces	113
7.3.2 Configure the WAN Trunk	114
7.4 How to Set Up an IPSec VPN Tunnel	116
7.4.1 Set Up the VPN Gateway	117
7.4.2 Set Up the VPN Connection	118
7.4.3 Configure Security Policies for the VPN Tunnel	119

7.5 How to Configure User-aware Access Control	120
7.5.1 Set Up User Accounts	120
7.5.2 Set Up User Groups	121
7.5.3 Set Up User Authentication Using the RADIUS Server	122
7.6 How to Use a RADIUS Server to Authenticate User Accounts based on Groups	124
7.7 How to Use Endpoint Security and Authentication Policies	126
7.7.1 Configure the Endpoint Security Objects	126
7.7.2 Configure the Authentication Policy	128
7.8 How to Configure Service Control	129
7.8.1 Allow HTTPS Administrator Access Only From the LAN	130
7.9 How to Allow Incoming H.323 Peer-to-peer Calls	132
7.9.1 Turn On the ALG	133
7.9.2 Set Up a NAT Policy For H.323	133
7.9.3 Set Up a Firewall Rule For H.323	135
7.10 How to Allow Public Access to a Web Server	136
7.10.1 Create the Address Objects	137
7.10.2 Configure NAT	137
7.10.3 Set Up a Firewall Rule	138
7.11 How to Use an IPPBX on the DMZ	139
7.11.1 Turn On the ALG	141
7.11.2 Create the Address Objects	141
7.11.3 Setup a NAT Policy for the IPPBX	142
7.11.4 Set Up a WAN to DMZ Firewall Rule for SIP	143
7.11.5 Set Up a DMZ to LAN Firewall Rule for SIP	144
7.12 How to Use Multiple Static Public WAN IP Addresses for LAN to WAN Traffic	145
7.12.1 Create the Public IP Address Range Object	145
7.12.2 Configure the Policy Route	146
7.13 How to Set Up a Wireless LAN	146
7.13.1 Set Up User Accounts	147
7.13.2 Create the WLAN Interface	147
7.13.3 Set Up the Wireless Clients to Use the WLAN Interface	150

Part II: Technical Reference 163

**Chapter 8
Dashboard 165**

8.1 Overview	165
8.1.1 What You Can Do in this Chapter	165
8.2 The Dashboard Screen	165
8.2.1 The CPU Usage Screen	171
8.2.2 The Memory Usage Screen	172

8.2.3 The Active Sessions Screen	173
8.2.4 The VPN Status Screen	174
8.2.5 The DHCP Table Screen	174
8.2.6 The Number of Login Users Screen	175
Chapter 9	
Monitor.....	177
9.1 Overview	177
9.1.1 What You Can Do in this Chapter	177
9.2 The Port Statistics Screen	178
9.2.1 The Port Statistics Graph Screen	180
9.3 Interface Status Screen	181
9.4 The Traffic Statistics Screen	183
9.5 The Session Monitor Screen	186
9.6 The DDNS Status Screen	189
9.7 IP/MAC Binding Monitor	189
9.8 The Login Users Screen	190
9.9 WLAN Status Screen	191
9.10 The following table describes the labels in this menu.Cellular Status Screen	192
9.10.1 More Information	194
9.11 USB Storage Screen	195
9.12 The IPSec Monitor Screen	196
9.12.1 Regular Expressions in Searching IPSec SAs	198
9.13 The SSL Connection Monitor Screen	198
9.14 The Content Filter Statistics Screen	200
9.15 Content Filter Cache Screen	202
9.16 The Anti-Spam Statistics Screen	204
9.17 The Anti-Spam Status Screen	206
9.18 Log Screen	207
Chapter 10	
Registration.....	211
10.1 Overview	211
10.1.1 What You Can Do in this Chapter	211
10.1.2 What you Need to Know	211
10.2 The Registration Screen	212
10.3 The Service Screen	214
Chapter 11	
Interfaces.....	217
11.1 Interface Overview	217
11.1.1 What You Can Do in this Chapter	217
11.1.2 What You Need to Know	218

11.2 Port Role	220
11.3 Ethernet Summary Screen	222
11.3.1 Ethernet Edit	223
11.3.2 Object References	232
11.4 PPP Interfaces	233
11.4.1 PPP Interface Summary	234
11.4.2 PPP Interface Add or Edit	235
11.5 Cellular Configuration Screen (3G)	239
11.5.1 Cellular Add/Edit Screen	241
11.6 WLAN Interface General Screen	248
11.6.1 WLAN Add/Edit Screen	252
11.6.2 WLAN Add/Edit: WEP Security	258
11.6.3 WLAN Add/Edit: WPA-PSK/WPA2-PSK Security	259
11.6.4 WLAN Add/Edit: WPA/WPA2 Security	260
11.7 WLAN Interface MAC Filter	262
11.8 VLAN Interfaces	264
11.8.1 VLAN Summary Screen	266
11.8.2 VLAN Add/Edit	267
11.9 Bridge Interfaces	274
11.9.1 Bridge Summary	276
11.9.2 Bridge Add/Edit	277
11.9.3 Virtual Interfaces Add/Edit	282
11.10 Interface Technical Reference	284
Chapter 12	
Trunks	289
12.1 Overview	289
12.1.1 What You Can Do in this Chapter	289
12.1.2 What You Need to Know	290
12.2 The Trunk Summary Screen	292
12.3 Configuring a Trunk	293
12.4 Trunk Technical Reference	295
Chapter 13	
Policy and Static Routes	297
13.1 Policy and Static Routes Overview	297
13.1.1 What You Can Do in this Chapter	297
13.1.2 What You Need to Know	298
13.2 Policy Route Screen	300
13.2.1 Policy Route Edit Screen	303
13.3 IP Static Route Screen	307
13.3.1 Static Route Add/Edit Screen	308
13.4 Policy Routing Technical Reference	309

Chapter 14	
Routing Protocols	313
14.1 Routing Protocols Overview	313
14.1.1 What You Can Do in this Chapter	313
14.1.2 What You Need to Know	313
14.2 The RIP Screen	314
14.3 The OSPF Screen	315
14.3.1 Configuring the OSPF Screen	319
14.3.2 OSPF Area Add/Edit Screen	322
14.3.3 Virtual Link Add/Edit Screen	323
14.4 Routing Protocol Technical Reference	324
Chapter 15	
Zones	327
15.1 Zones Overview	327
15.1.1 What You Can Do in this Chapter	327
15.1.2 What You Need to Know	328
15.2 The Zone Screen	329
15.3 Zone Edit	330
Chapter 16	
DDNS	331
16.1 DDNS Overview	331
16.1.1 What You Can Do in this Chapter	331
16.1.2 What You Need to Know	331
16.2 The DDNS Screen	332
16.2.1 The Dynamic DNS Add/Edit Screen	334
Chapter 17	
NAT	337
17.1 NAT Overview	337
17.1.1 What You Can Do in this Chapter	337
17.1.2 What You Need to Know	338
17.2 The NAT Screen	338
17.2.1 The NAT Add/Edit Screen	340
17.3 NAT Technical Reference	343
Chapter 18	
HTTP Redirect	347
18.1 Overview	347
18.1.1 What You Can Do in this Chapter	347
18.1.2 What You Need to Know	348
18.2 The HTTP Redirect Screen	349

18.2.1 The HTTP Redirect Edit Screen	350
Chapter 19	
ALG	351
19.1 ALG Overview	351
19.1.1 What You Can Do in this Chapter	351
19.1.2 What You Need to Know	352
19.1.3 Before You Begin	355
19.2 The ALG Screen	355
19.3 ALG Technical Reference	357
Chapter 20	
IP/MAC Binding	359
20.1 IP/MAC Binding Overview	359
20.1.1 What You Can Do in this Chapter	359
20.1.2 What You Need to Know	360
20.2 IP/MAC Binding Summary	360
20.2.1 IP/MAC Binding Edit	361
20.2.2 Static DHCP Edit	362
20.3 IP/MAC Binding Exempt List	363
Chapter 21	
Authentication Policy	365
21.1 Overview	365
21.1.1 What You Can Do in this Chapter	365
21.1.2 What You Need to Know	366
21.2 Authentication Policy Screen	366
21.2.1 Creating/Editing an Authentication Policy	369
Chapter 22	
Firewall	373
22.1 Overview	373
22.1.1 What You Can Do in this Chapter	373
22.1.2 What You Need to Know	374
22.1.3 Firewall Rule Example Applications	376
22.1.4 Firewall Rule Configuration Example	379
22.2 The Firewall Screen	381
22.2.1 Configuring the Firewall Screen	382
22.2.2 The Firewall Add/Edit Screen	385
22.3 The Session Limit Screen	386
22.3.1 The Session Limit Add/Edit Screen	388
Chapter 23	
IPSec VPN	391

23.1 IPsec VPN Overview	391
23.1.1 What You Can Do in this Chapter	391
23.1.2 What You Need to Know	392
23.1.3 Before You Begin	394
23.2 The VPN Connection Screen	394
23.2.1 The VPN Connection Add/Edit (IKE) Screen	396
23.2.2 The VPN Connection Add/Edit Manual Key Screen	403
23.3 The VPN Gateway Screen	406
23.3.1 The VPN Gateway Add/Edit Screen	407
23.4 IPsec VPN Background Information	415
Chapter 24	
SSL VPN.....	427
24.1 Overview	427
24.1.1 What You Can Do in this Chapter	427
24.1.2 What You Need to Know	427
24.2 The SSL Access Privilege Screen	429
24.2.1 The SSL Access Policy Add/Edit Screen	430
24.3 The SSL Global Setting Screen	433
24.3.1 How to Upload a Custom Logo	434
24.4 Establishing an SSL VPN Connection	435
Chapter 25	
SSL User Screens	437
25.1 Overview	437
25.1.1 What You Need to Know	437
25.2 Remote User Login	438
25.3 The SSL VPN User Screens	443
25.4 Bookmarking the ZyWALL	444
25.5 Logging Out of the SSL VPN User Screens	444
Chapter 26	
SSL User Application Screens	447
26.1 SSL User Application Screens Overview	447
26.2 The Application Screen	447
Chapter 27	
ZyWALL SecuExtender.....	449
27.1 The ZyWALL SecuExtender Icon	449
27.2 Statistics	450
27.3 View Log	451
27.4 Suspend and Resume the Connection	451
27.5 Stop the Connection	452

27.6 Uninstalling the ZyWALL SecuExtender	452
Chapter 28	
Bandwidth Management.....	453
28.1 Overview	453
28.1.1 What You Can Do in this Chapter	453
28.1.2 What You Need to Know	453
28.1.3 Bandwidth Management Examples	457
28.2 TheBandwidth Management Screen	461
28.2.1 The Bandwidth Management Add/Edit Screen	463
Chapter 29	
ADP	467
29.1 Overview	467
29.1.1 ADP	467
29.1.2 What You Can Do in this Chapter	467
29.1.3 What You Need To Know	467
29.1.4 Before You Begin	468
29.2 The ADP General Screen	469
29.3 The Profile Summary Screen	470
29.3.1 Base Profiles	471
29.3.2 Configuring The ADP Profile Summary Screen	471
29.3.3 Creating New ADP Profiles	472
29.3.4 Traffic Anomaly Profiles	472
29.3.5 Protocol Anomaly Profiles	475
29.3.6 Protocol Anomaly Configuration	475
29.4 ADP Technical Reference	479
Chapter 30	
Content Filtering	487
30.1 Overview	487
30.1.1 What You Can Do in this Chapter	487
30.1.2 What You Need to Know	487
30.1.3 Before You Begin	489
30.2 Content Filter General Screen	489
30.3 Content Filter Policy Add or Edit Screen	492
30.4 Content Filter Profile Screen	494
30.5 Content Filter Categories Screen	494
30.5.1 Content Filter Blocked and Warning Messages	508
30.6 Content Filter Customization Screen	508
30.7 Content Filter Technical Reference	511
Chapter 31	
Content Filter Reports	513

31.1 Overview	513
31.2 Viewing Content Filter Reports	513
Chapter 32	
Anti-Spam	521
32.1 Overview	521
32.1.1 What You Can Do in this Chapter	521
32.1.2 What You Need to Know	521
32.2 Before You Begin	523
32.3 The Anti-Spam General Screen	523
32.3.1 The Anti-Spam Policy Add or Edit Screen	525
32.4 The Anti-Spam Black List Screen	527
32.4.1 The Anti-Spam Black or White List Add/Edit Screen	529
32.4.2 Regular Expressions in Black or White List Entries	530
32.5 The Anti-Spam White List Screen	531
32.6 The DNSBL Screen	532
32.7 Anti-Spam Technical Reference	534
Chapter 33	
User/Group	539
33.1 Overview	539
33.1.1 What You Can Do in this Chapter	539
33.1.2 What You Need To Know	539
33.2 User Summary Screen	542
33.2.1 User Add/Edit Screen	542
33.3 User Group Summary Screen	545
33.3.1 Group Add/Edit Screen	546
33.4 Setting Screen	547
33.4.1 Default User Authentication Timeout Settings Edit Screens	550
33.4.2 User Aware Login Example	552
33.5 User /Group Technical Reference	553
Chapter 34	
Addresses	555
34.1 Overview	555
34.1.1 What You Can Do in this Chapter	555
34.1.2 What You Need To Know	555
34.2 Address Summary Screen	555
34.2.1 Address Add/Edit Screen	557
34.3 Address Group Summary Screen	558
34.3.1 Address Group Add/Edit Screen	559
Chapter 35	
Services	561

35.1 Overview	561
35.1.1 What You Can Do in this Chapter	561
35.1.2 What You Need to Know	561
35.2 The Service Summary Screen	562
35.2.1 The Service Add/Edit Screen	564
35.3 The Service Group Summary Screen	564
35.3.1 The Service Group Add/Edit Screen	566
Chapter 36	
Schedules	567
36.1 Overview	567
36.1.1 What You Can Do in this Chapter	567
36.1.2 What You Need to Know	567
36.2 The Schedule Summary Screen	568
36.2.1 The One-Time Schedule Add/Edit Screen	569
36.2.2 The Recurring Schedule Add/Edit Screen	570
Chapter 37	
AAA Server	573
37.1 Overview	573
37.1.1 Directory Service (AD/LDAP)	573
37.1.2 RADIUS Server	574
37.1.3 ASAS	574
37.1.4 What You Can Do in this Chapter	574
37.1.5 What You Need To Know	575
37.2 Active Directory or LDAP Server Summary	577
37.2.1 Adding an Active Directory or LDAP Server	577
37.3 RADIUS Server Summary	579
37.3.1 Adding a RADIUS Server	581
Chapter 38	
Authentication Method	583
38.1 Overview	583
38.1.1 What You Can Do in this Chapter	583
38.1.2 Before You Begin	583
38.1.3 Example: Selecting a VPN Authentication Method	583
38.2 Authentication Method Objects	584
38.2.1 Creating an Authentication Method Object	585
Chapter 39	
Certificates	589
39.1 Overview	589
39.1.1 What You Can Do in this Chapter	589

39.1.2 What You Need to Know	589
39.1.3 Verifying a Certificate	591
39.2 The My Certificates Screen	593
39.2.1 The My Certificates Add Screen	594
39.2.2 The My Certificates Edit Screen	599
39.2.3 The My Certificates Import Screen	602
39.3 The Trusted Certificates Screen	603
39.3.1 The Trusted Certificates Edit Screen	604
39.3.2 The Trusted Certificates Import Screen	608
39.4 Certificates Technical Reference	609
Chapter 40	
ISP Accounts	611
40.1 Overview	611
40.1.1 What You Can Do in this Chapter	611
40.2 ISP Account Summary	611
40.2.1 ISP Account Edit	612
Chapter 41	
SSL Application	615
41.1 Overview	615
41.1.1 What You Can Do in this Chapter	615
41.1.2 What You Need to Know	615
41.1.3 Example: Specifying a Web Site for Access	616
41.2 The SSL Application Screen	617
41.2.1 Creating/Editing a Web-based SSL Application Object	618
Chapter 42	
Endpoint Security	621
42.1 Overview	621
42.1.1 What You Can Do in this Chapter	622
42.1.2 What You Need to Know	622
42.2 Endpoint Security Screen	623
42.3 Endpoint Security Add/Edit	624
Chapter 43	
System	629
43.1 Overview	629
43.1.1 What You Can Do in this Chapter	629
43.2 Host Name	630
43.3 USB Storage	631
43.4 Date and Time	631
43.4.1 Pre-defined NTP Time Servers List	634

43.4.2 Time Server Synchronization	635
43.5 Console Port Speed	636
43.6 DNS Overview	636
43.6.1 DNS Server Address Assignment	637
43.6.2 Configuring the DNS Screen	637
43.6.3 Address Record	640
43.6.4 PTR Record	640
43.6.5 Adding an Address/PTR Record	640
43.6.6 Domain Zone Forwarder	641
43.6.7 Adding a Domain Zone Forwarder	641
43.6.8 MX Record	642
43.6.9 Adding a MX Record	643
43.6.10 Adding a DNS Service Control Rule	643
43.7 WWW Overview	644
43.7.1 Service Access Limitations	644
43.7.2 System Timeout	645
43.7.3 HTTPS	645
43.7.4 Configuring WWW Service Control	646
43.7.5 Service Control Rules	650
43.7.6 Customizing the WWW Login Page	650
43.7.7 HTTPS Example	654
43.8 SSH	661
43.8.1 How SSH Works	662
43.8.2 SSH Implementation on the ZyWALL	663
43.8.3 Requirements for Using SSH	663
43.8.4 Configuring SSH	663
43.8.5 Secure Telnet Using SSH Examples	665
43.9 Telnet	666
43.9.1 Configuring Telnet	667
43.10 FTP	668
43.10.1 Configuring FTP	668
43.11 SNMP	670
43.11.1 Supported MIBs	672
43.11.2 SNMP Traps	672
43.11.3 Configuring SNMP	672
43.12 Vantage CNM	674
43.12.1 Configuring Vantage CNM	675
43.13 Language Screen	677
Chapter 44	
Log and Report	679
44.1 Overview	679
44.1.1 What You Can Do In this Chapter	679

44.2 Email Daily Report	679
44.3 Log Setting Screens	681
44.3.1 Log Setting Summary	682
44.3.2 Edit System Log Settings	683
44.3.3 Edit Remote Server Log Settings	688
44.3.4 Active Log Summary Screen	690
Chapter 45	
File Manager	693
45.1 Overview	693
45.1.1 What You Can Do in this Chapter	693
45.1.2 What you Need to Know	693
45.2 The Configuration File Screen	696
45.3 The Firmware Package Screen	700
45.4 The Shell Script Screen	702
Chapter 46	
Diagnostics.....	705
46.1 Overview	705
46.1.1 What You Can Do in this Chapter	705
46.2 The Diagnostic Screen	705
46.2.1 The Diagnostics Files Screen	706
46.3 The Packet Capture Screen	707
46.3.1 The Packet Capture Files Screen	710
46.3.2 Example of Viewing a Packet Capture File	711
46.4 Core Dump Screen	712
46.4.1 Core Dump Files Screen	713
46.5 The System Log Screen	714
Chapter 47	
Packet Flow Explore.....	715
47.1 Overview	715
47.1.1 What You Can Do in this Chapter	715
47.2 The Routing Status Screen	715
47.3 The SNAT Status Screen	719
Chapter 48	
Reboot.....	723
48.1 Overview	723
48.1.1 What You Need To Know	723
48.2 The Reboot Screen	723
Chapter 49	
Shutdown.....	725

49.1 Overview	725
49.1.1 What You Need To Know	725
49.2 The Shutdown Screen	725
Chapter 50	
Troubleshooting.....	727
50.1 Resetting the ZyWALL	738
50.2 Getting More Troubleshooting Help	739
Chapter 51	
Product Specifications.....	741
51.1 Power Adaptor Specifications	745
Appendix A Log Descriptions	747
Appendix B Common Services.....	799
Appendix C Wireless LANs	803
Appendix D Importing Certificates.....	819
Appendix E Open Software Announcements	845
Appendix F Legal Information	935
Index.....	939

PART I

User's Guide

Introducing the ZyWALL

This chapter gives an overview of the ZyWALL. It explains the front panel ports, LEDs, introduces the management methods, and lists different ways to start or stop the ZyWALL.

1.1 Overview and Key Default Settings

The ZyWALL is a comprehensive security device. Its flexible configuration helps network administrators set up the network and enforce security policies efficiently. In addition, the ZyWALL provides excellent throughput, making it an ideal solution for reliable, secure service.

The ZyWALL's security features include VPN, firewall, content filtering, ADP (Anomaly Detection and Protection), and certificates. It also provides bandwidth management, Instant Messaging (IM) and Peer to Peer (P2P) control, NAT, port forwarding, policy routing, DHCP server and many other powerful features. Flexible configuration helps you set up the network and enforce security policies efficiently. See [Chapter 2 on page 37](#) for a more detailed overview of the ZyWALL's features.

The ZyWALL provides excellent throughput with the reliability of dual WAN Gigabit Ethernet ports and load balancing. You can also use a 3G cellular USB (not included) for a third WAN connection.

The ZyWALL lets you set up multiple networks for your company. The De-Militarized Zone (DMZ) increases LAN security by providing separate ports for connecting publicly accessible servers. The ZyWALL also provides two separate LAN networks. You can set ports to be part of the LAN1, WLAN, or DMZ. Alternatively, you can deploy the ZyWALL as a transparent firewall in an existing network with minimal configuration.

1.2 Wall-mounting

Do the following to attach your ZyWALL to a wall.

- 1 Screw the two screws provided with your ZyWALL into the wall 150 mm apart (see the figure in step 2). Use screws with 6 mm ~ 8 mm (0.24" ~ 0.31") wide heads. Do not screw the screws all the way in to the wall; leave a small gap between the head of the screw and the wall.

The gap must be big enough for the screw heads to slide into the screw slots and the connection cables to run down the back of the ZyWALL.

Note: Make sure the screws are securely fixed to the wall and strong enough to hold the weight of the ZyWALL with the connection cables.

- 2 Align the holes on the back of the ZyWALL with the screws on the wall. Hang the ZyWALL on the screws.

USG 20

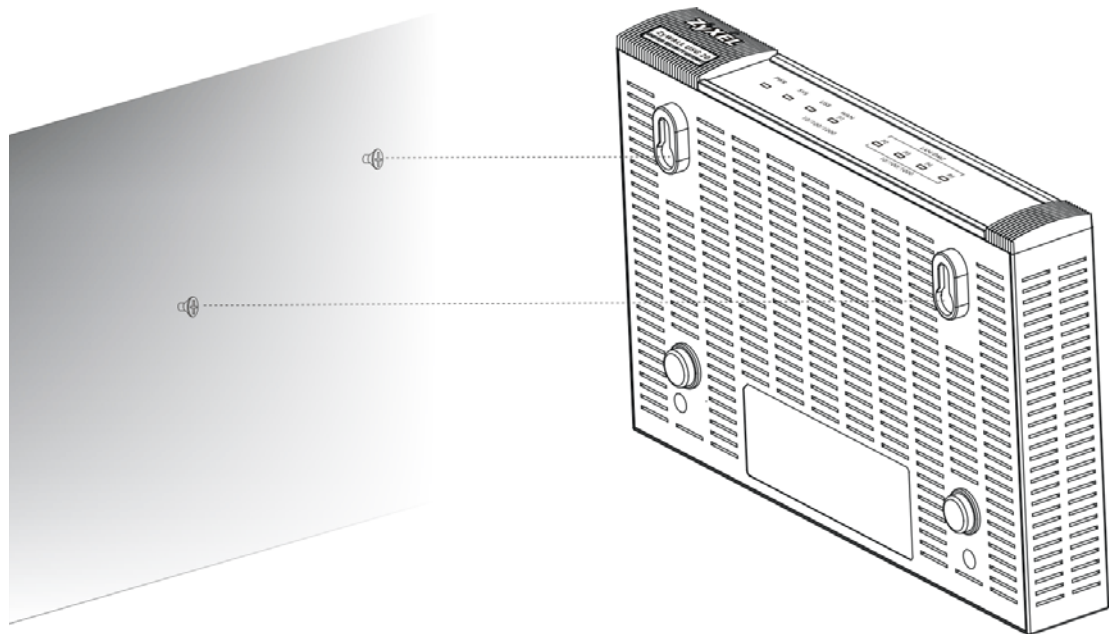

USG 20W

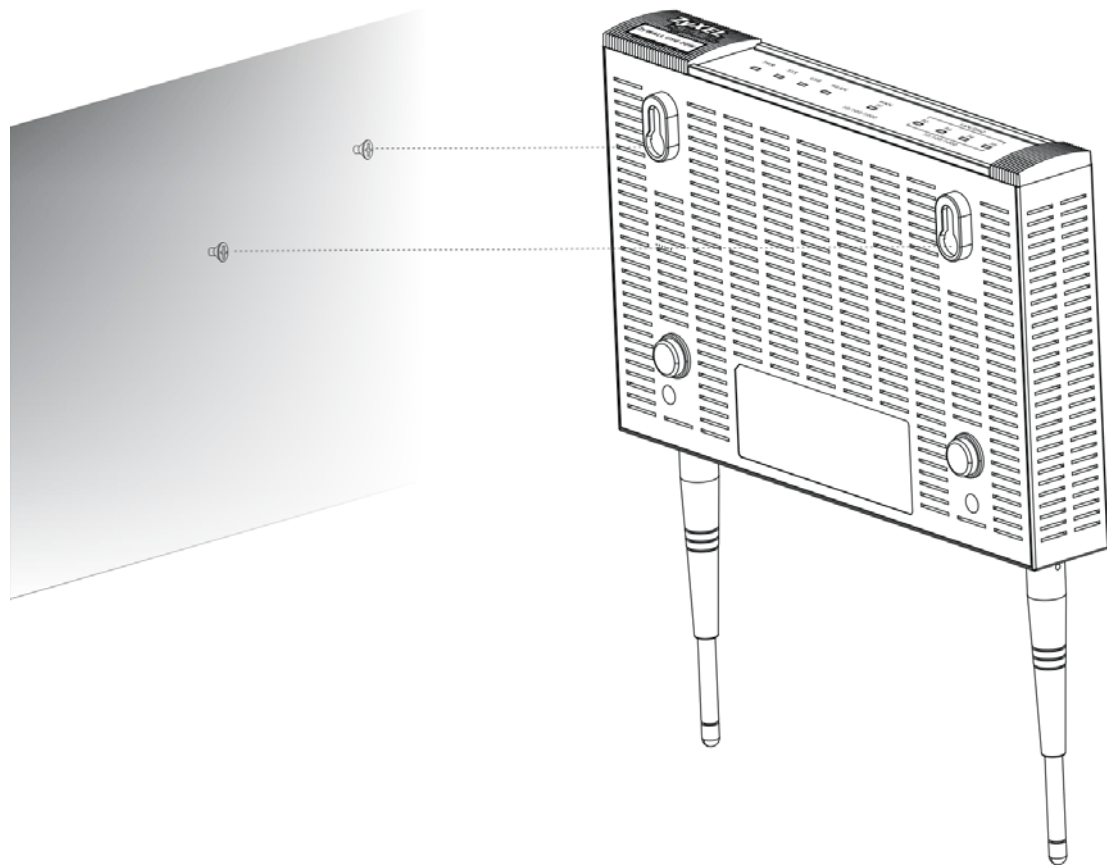

The ZyWALL should be wall-mounted horizontally. The ZyWALL's side panels with ventilation slots should not be facing up or down as this position is less safe.

1.3 Front Panel

This section introduces the ZyWALL's front panel.

Figure 1 ZyWALL Front Panel

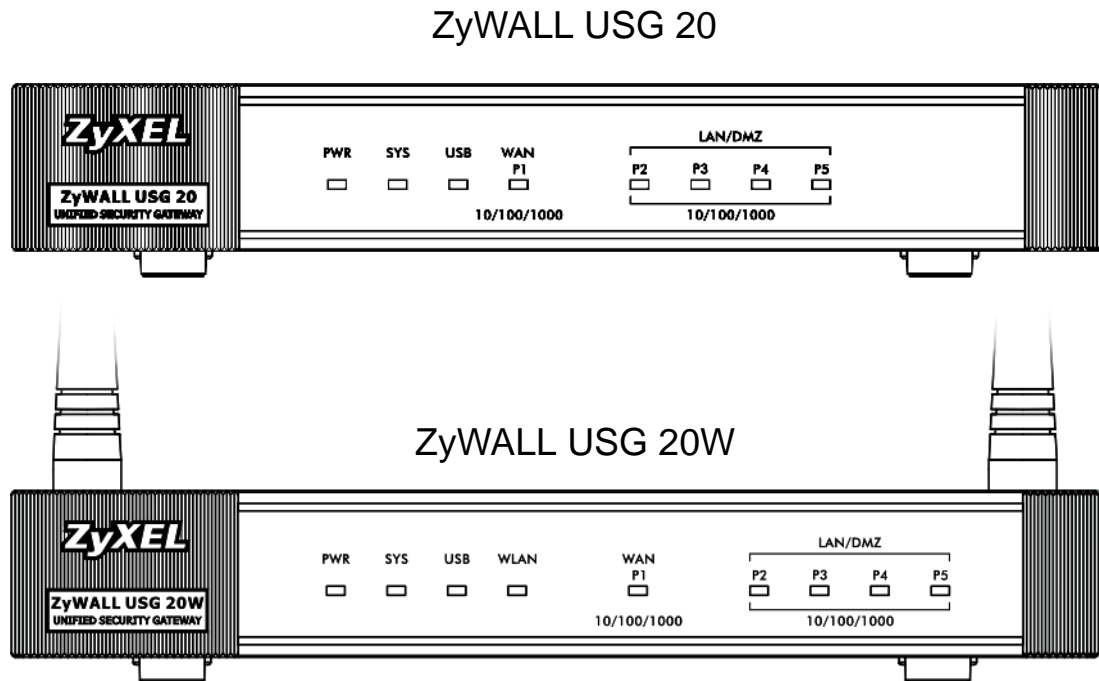

1.3.1 Front Panel LEDs

The following table describes the LEDs.

Table 1 Front Panel LEDs

LED	COLOR	STATUS	DESCRIPTION
PWR		Off	The ZyWALL is turned off.
	Green	On	The ZyWALL is turned on.
		Breathing	The ZyWALL is in power saving mode.
Red	On	There is a hardware component failure. Shut down the device, wait for a few minutes and then restart the device (see Section 1.5 on page 34). If the LED turns red again, then please contact your vendor.	
SYS	Green	Off	The ZyWALL is not ready or has failed.
		On	The ZyWALL is ready and running.
		Blinking	The ZyWALL is booting.
	Red	On	The ZyWALL had an error or has failed.

Table 1 Front Panel LEDs (continued)

LED	COLOR	STATUS	DESCRIPTION
USB	Green	Off	No device is connected to the ZyWALL's USB port or the connected device is not supported by the ZyWALL.
		On	A 3G USB card or a USB storage device is connected to the ZyWALL's USB port.
	Orange	On	The ZyWALL is connected to a 3G network through the connected 3G USB card.
WLAN (20W Only)	Green	Off	The wireless function is disabled on the ZyWALL.
		On	The wireless function is enabled on the ZyWALL.
P1~P5	Green	Off	There is no traffic on this port.
		Blinking	The ZyWALL is sending or receiving packets on this port.
	Orange	Off	There is no connection on this port.
		On	This port has a successful link.

1.4 Management Overview

You can use the following ways to manage the ZyWALL.

Web Configurator

The Web Configurator allows easy ZyWALL setup and management using an Internet browser. This User's Guide provides information about the Web Configurator.

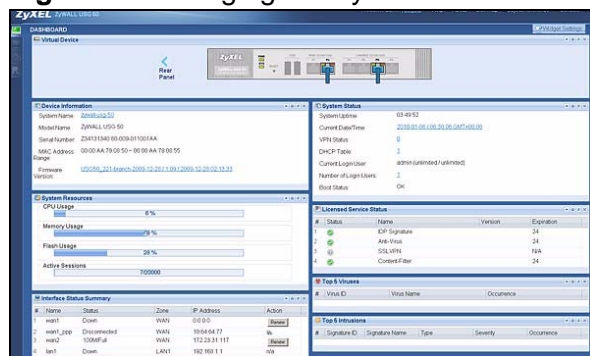
Figure 2 Managing the ZyWALL: Web Configurator

Command-Line Interface (CLI)

The CLI allows you to use text-based commands to configure the ZyWALL. You can access it using remote management (for example, SSH or Telnet) or via the

console port. See the Command Reference Guide for more information about the CLI.

Console Port

You can use the console port to manage the ZyWALL using CLI commands. See the Command Reference Guide for more information about the CLI.

The default settings for the console port are as follows.

Table 2 Console Port Default Settings

SETTING	VALUE
Speed	115200 bps
Data Bits	8
Parity	None
Stop Bit	1
Flow Control	Off

1.5 Starting and Stopping the ZyWALL

Here are some of the ways to start and stop the ZyWALL.

Always use **Maintenance > Shutdown > Shutdown** or the `shutdown` command before you turn off the ZyWALL or remove the power. Not doing so can cause the firmware to become corrupt.

Table 3 Starting and Stopping the ZyWALL

METHOD	DESCRIPTION
Turning on the power	A cold start occurs when you turn on the power to the ZyWALL. The ZyWALL powers up, checks the hardware, and starts the system processes.
Rebooting the ZyWALL	A warm start (without powering down and powering up again) occurs when you use the Reboot button in the Reboot screen or when you use the <code>reboot</code> command. The ZyWALL writes all cached data to the local storage, stops the system processes, and then does a warm start.
Using the RESET button	If you press the RESET button, the ZyWALL sets the configuration to its default values and then reboots.

Table 3 Starting and Stopping the ZyWALL

METHOD	DESCRIPTION
Clicking Maintenance > Shutdown > Shutdown or using the <code>shutdown</code> command	Clicking Maintenance > Shutdown > Shutdown or using the <code>shutdown</code> command writes all cached data to the local storage and stops the system processes. Wait for the device to shut down and then manually turn off or remove the power. It does not turn off the power.
Disconnecting the power	Power off occurs when you turn off the power to the ZyWALL. The ZyWALL simply turns off. It does not stop the system processes or write cached data to local storage.

The ZyWALL does not stop or start the system processes when you apply configuration files or run shell scripts although you may temporarily lose access to network resources.

Features and Applications

This chapter introduces the main features and applications of the ZyWALL.

2.1 Features

The ZyWALL's security features include VPN, firewall content filtering, ADP (Anomaly Detection and Protection), and certificates. It also provides bandwidth management, NAT, port forwarding, policy routing, DHCP server and many other powerful features.

The rest of this section provides more information about the features of the ZyWALL.

High Availability

To ensure the ZyWALL provides reliable, secure Internet access, set up one or more of the following:

- Multiple WAN ports and configure load balancing between these ports.
- One or more 3G (cellular) connections.

Virtual Private Networks (VPN)

Use IPSec, SSL to provide secure communication between two sites over the Internet or any insecure network that uses TCP/IP for communication. The ZyWALL also offers hub-and-spoke IPSec VPN.

Flexible Security Zones

Many security settings are made by zone, not by interface, port, or network. As a result, it is much simpler to set up and to change security settings in the ZyWALL. You can create your own custom zones. You can add interfaces and VPN tunnels to zones.

Firewall

The ZyWALL's firewall is a stateful inspection firewall. The ZyWALL restricts access by screening data packets against defined access rules. It can also inspect sessions. For example, traffic from one zone is not allowed unless it is initiated by a computer in another zone first.

Anomaly Detection and Prevention (ADP)

ADP (Anomaly Detection and Prevention) can detect malicious or suspicious packets and respond instantaneously. It can detect:

- Anomalies based on violations of protocol standards (RFCs – Requests for Comments)
- Abnormal flows such as port scans.

The ZyWALL's ADP protects against network-based intrusions. See [Section 29.3.4 on page 472](#) and [Section 29.3.5 on page 475](#) for more on the kinds of attacks that the ZyWALL can protect against. You can also create your own custom ADP rules.

Bandwidth Management

Bandwidth management allows you to allocate network resources according to defined policies. This policy-based bandwidth allocation helps your network to better handle applications such as Internet access, e-mail, Voice-over-IP (VoIP), video conferencing and other business-critical applications.

Content Filter

Content filtering allows schools and businesses to create and enforce Internet access policies tailored to the needs of the organization.

You can also subscribe to category-based content filtering that allows your ZyWALL to check web sites against an external database of dynamically-updated ratings of millions of web sites. You then simply select categories to block or monitor, such as pornography or racial intolerance, from a pre-defined list.

Anti-Spam

The anti-spam feature can mark or discard spam. Use the white list to identify legitimate e-mail. Use the black list to identify spam e-mail. The ZyWALL can also check e-mail against a DNS black list (DNSBL) of IP addresses of servers that are suspected of being used by spammers.

2.2 Applications

These are some example applications for your ZyWALL. See also [Chapter 7 on page 107](#) for configuration tutorial examples.

2.2.1 VPN Connectivity

Set up VPN tunnels with other companies, branch offices, telecommuters, and business travelers to provide secure access to your network. You can also set up additional connections to the Internet to provide better service.

Figure 3 Applications: VPN Connectivity

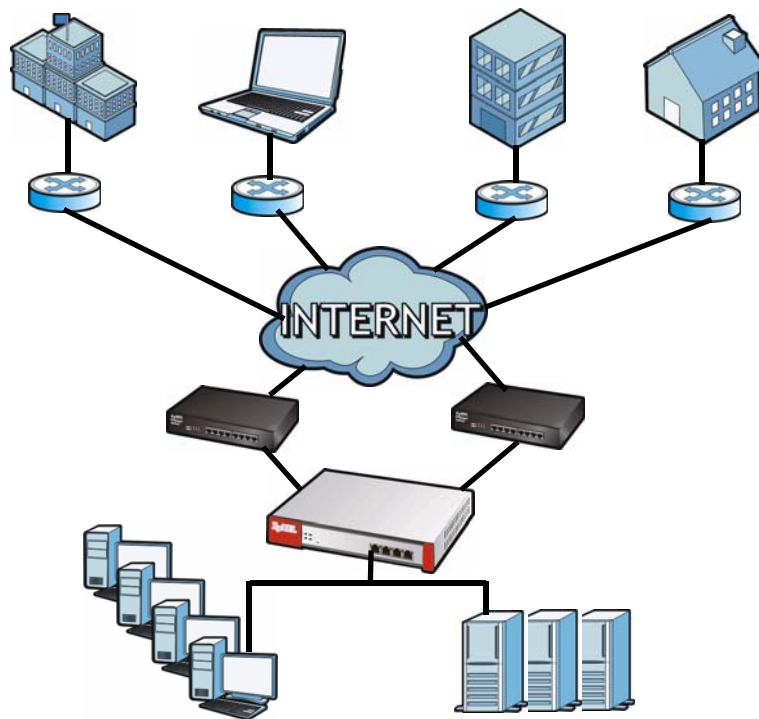

2.2.2 SSL VPN Network Access

You can configure the ZyWALL to provide SSL VPN network access to remote users.

2.2.2.1 Full Tunnel Mode

In full tunnel mode, a virtual connection is created for remote users with private IP addresses in the same subnet as the local network. This allows them to access network resources in the same way as if they were part of the internal network.

Figure 4 Network Access Mode: Full Tunnel Mode

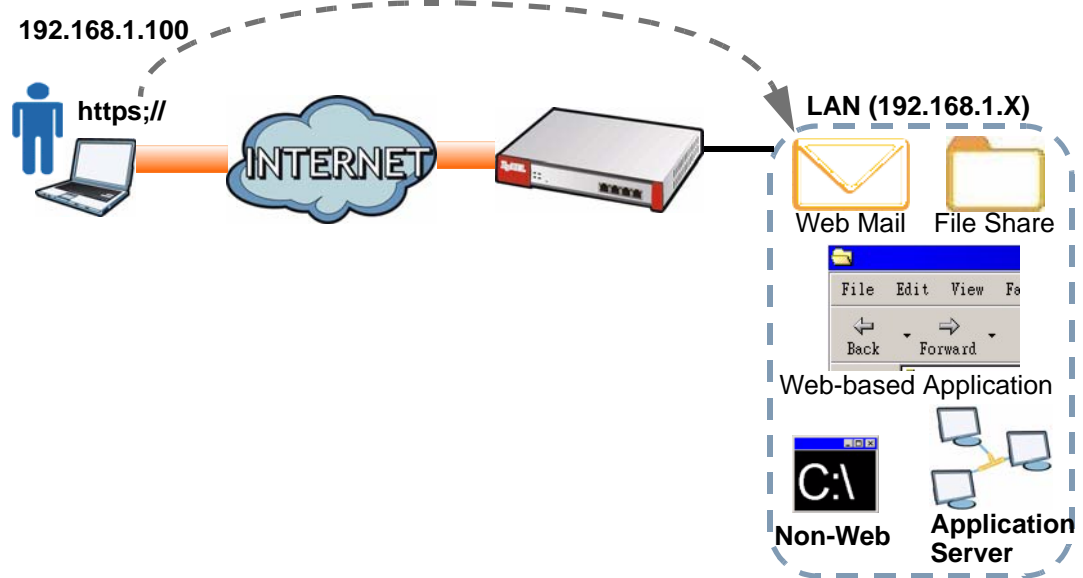

2.2.3 User-Aware Access Control

Set up security policies that restrict access to sensitive information and shared resources based on the user who is trying to access it.

Figure 5 Applications: User-Aware Access Control

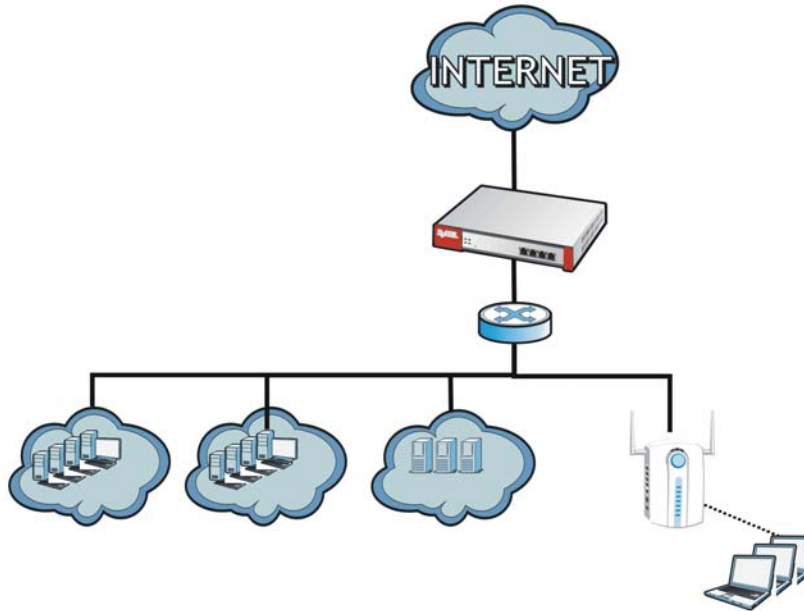

Web Configurator

The ZyWALL Web Configurator allows easy ZyWALL setup and management using an Internet browser.

3.1 Web Configurator Requirements

In order to use the Web Configurator, you must

- Use Internet Explorer 7 or later, or Firefox 1.5 or later
- Allow pop-up windows (blocked by default in Windows XP Service Pack 2)
- Enable JavaScripts (enabled by default)
- Enable Java permissions (enabled by default)
- Enable cookies

The recommended screen resolution is 1024 x 768 pixels.

3.2 Web Configurator Access

- 1 Make sure your ZyWALL hardware is properly connected. See the Quick Start Guide.

- 2 Open your web browser, and go to <http://192.168.1.1>. By default, the ZyWALL automatically routes this request to its HTTPS server, and it is recommended to keep this setting. The **Login** screen appears.

Figure 6 Login Screen

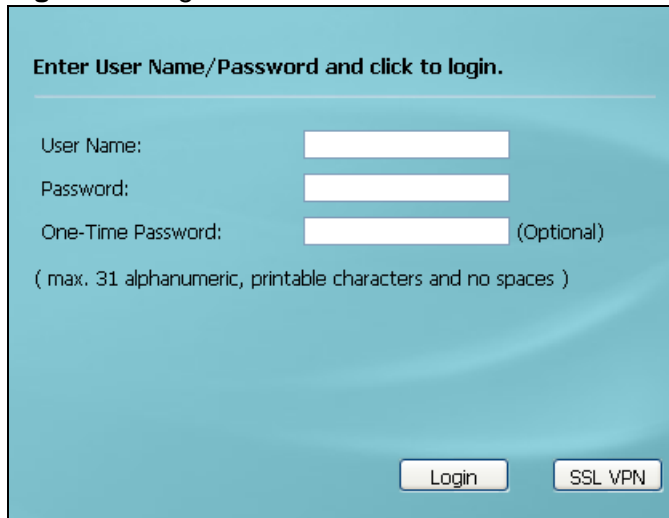

- 3 Type the user name (default: "admin") and password (default: "1234").
If your account is configured to use an ASAS authentication server, use the OTP (One-Time Password) token to generate a number. Enter it in the **One-Time Password** field. The number is only good for one login. You must use the token to generate a new number the next time you log in.
- 4 Click **Login**. If you logged in using the default user name and password, the **Update Admin Info** screen ([Figure 7 on page 44](#)) appears. Otherwise, the dashboard ([Figure 8 on page 45](#)) appears.

Figure 7 Update Admin Info Screen

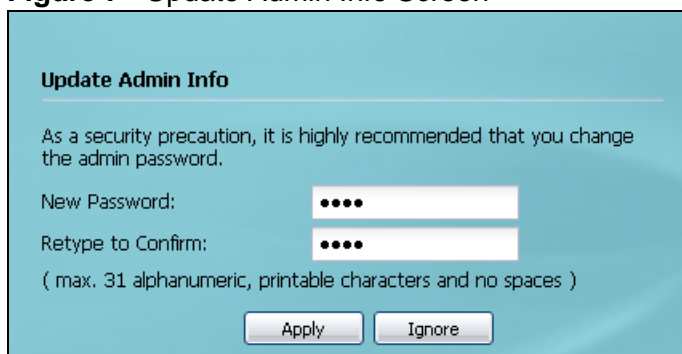

- 5 The screen above appears every time you log in using the default user name and default password. If you change the password for the default user account, this screen does not appear anymore.

Follow the directions in this screen. If you change the default password, the **Login** screen (Figure 6 on page 44) appears after you click **Apply**. If you click **Ignore**, the **Installation Setup Wizard** opens if the ZyWALL is using its default configuration (see Chapter 4 on page 59); otherwise the dashboard appears as shown next.

Figure 8 Dashboard

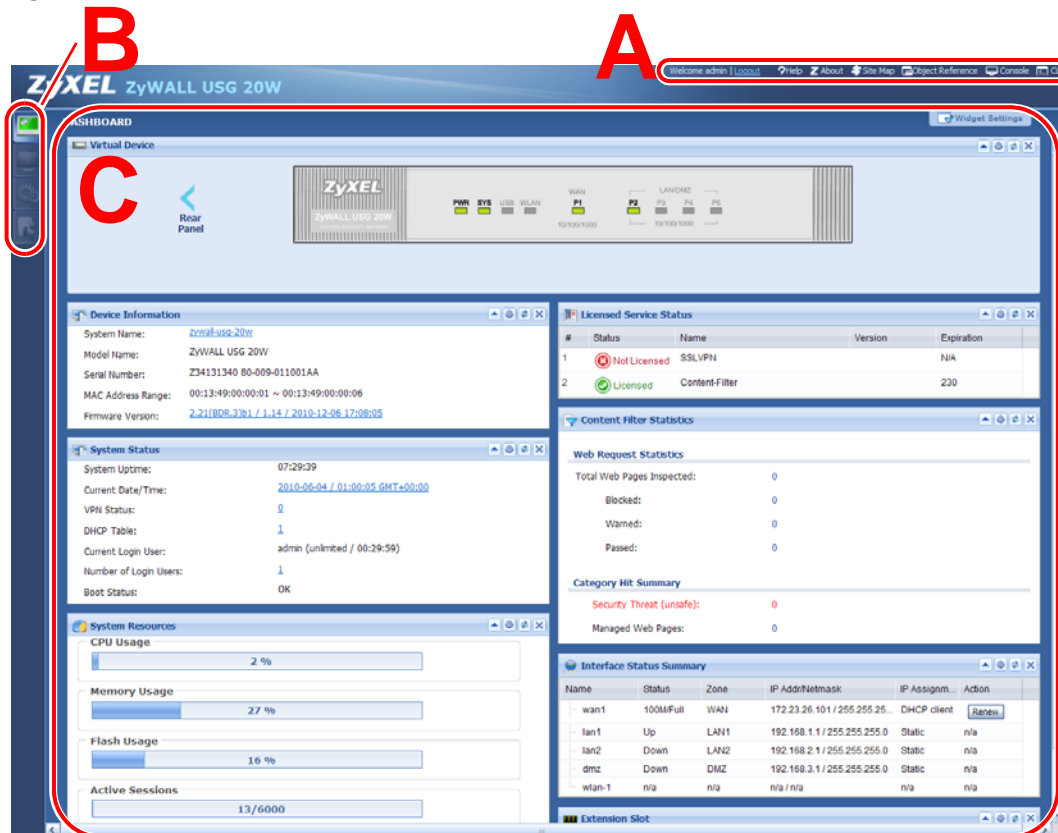

3.3 Web Configurator Screens Overview

The Web Configurator screen is divided into these parts (as illustrated in Figure 8 on page 45):

- **A** - title bar
- **B** - navigation panel
- **C** - main window

3.3.1 Title Bar

The title bar provides some icons in the upper right corner.

Figure 9 Title Bar



The icons provide the following functions.

Table 4 Title Bar: Web Configurator Icons

LABEL	DESCRIPTION
Logout	Click this to log out of the Web Configurator.
Help	Click this to open the help page for the current screen.
About	Click this to display basic information about the ZyWALL.
Site Map	Click this to see an overview of links to the Web Configurator screens.
Object Reference	Click this to open a screen where you can check which configuration items reference an object.
Console	Click this to open the console in which you can use the command line interface (CLI). See the CLI Reference Guide for details on the commands.
CLI	Click this to open a popup window that displays the CLI commands sent by the Web Configurator.

3.3.1.1 About

Click this to display basic information about the ZyWALL.

Figure 10 Title Bar

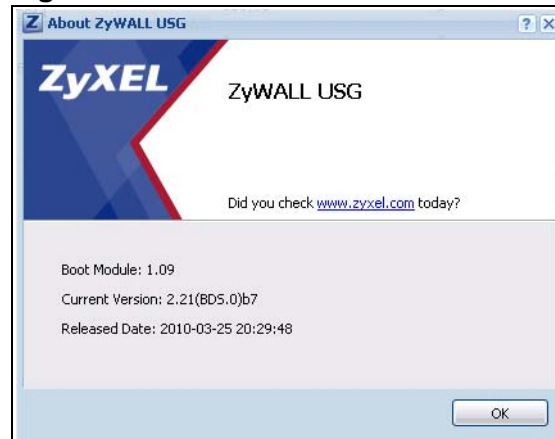

The following table describes labels that can appear in this screen.

Table 5 Title Bar: Web Configurator Icons

LABEL	DESCRIPTION
Boot Module	This shows the version number of the software that handles the booting process of the ZyWALL.
Current Version	This shows the firmware version of the ZyWALL.
Released Date	This shows the date (yyyy-mm-dd) and time (hh:mm:ss) when the firmware is released.
OK	Click this to close the screen.

3.3.2 Navigation Panel

Use the menu items on the navigation panel to open screens to configure ZyWALL features. Click the arrow in the middle of the right edge of the navigation panel to hide the navigation panel menus or drag it to resize them. The following sections introduce the ZyWALL's navigation panel menus and their screens.

Figure 11 Navigation Panel

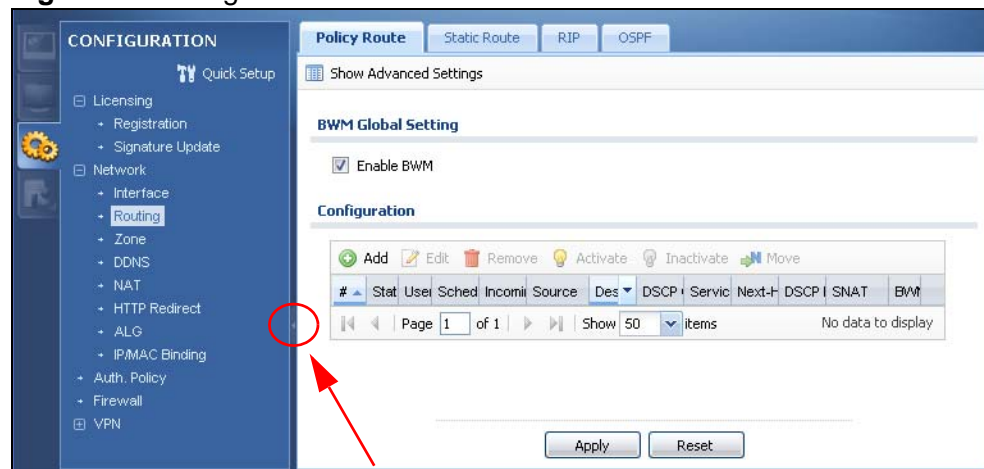

3.3.2.1 Dashboard

The dashboard displays general device information, system status, system resource usage, licensed service status, and interface status in widgets that you can re-arrange to suit your needs. See [Chapter 8 on page 165](#) for details on the dashboard.

3.3.2.2 Monitor Menu

The monitor menu screens display status and statistics information.

Table 6 Monitor Menu Screens Summary

FOLDER OR LINK	TAB	FUNCTION
System Status		
Port Statistics		Displays packet statistics for each physical port.
Interface Status		Displays general interface information and packet statistics.
Traffic Statistics		Collect and display traffic statistics.
Session Monitor		Displays the status of all current sessions.
DDNS Status		Displays the status of the ZyWALL's DDNS domain names.
IP/MAC Binding		Lists the devices that have received an IP address from ZyWALL interfaces using IP/MAC binding.
Login Users		Lists the users currently logged into the ZyWALL.
WLAN Status		(For USG 20W only) Displays the connection status of the ZyWALL's wireless clients.
Cellular Status		Displays details about the ZyWALL's 3G connection status.
VPN Monitor		
IPSec		Displays and manages the active IPSec SAs.
SSL		Lists users currently logged into the VPN SSL client portal. You can also log out individual users and delete related session information.
Anti-X Statistics		
Content Filter	Report	Collect and display content filter statistics
	Cache	Manage the ZyWALL's URL cache.
Anti-Spam	Report	Collect and display spam statistics.
	Status	Displays how many mail sessions the ZyWALL is currently checking and DNSBL (Domain Name Service-based spam Black List) statistics.
Log		Lists log entries.

3.3.2.3 Configuration Menu

Use the configuration menu screens to configure the ZyWALL's features.

Table 7 Configuration Menu Screens Summary

FOLDER OR LINK	TAB	FUNCTION
Quick Setup		Quickly configure WAN interfaces or VPN connections.
Licensing		
Registration	Registration	Register the device and activate trial services.
	Service	View the licensed service status and upgrade licensed services.

Table 7 Configuration Menu Screens Summary (continued)

FOLDER OR LINK	TAB	FUNCTION
Interface	Port Role	Use this screen to set the ZyWALL's flexible ports as LAN1 or DMZ.
	Ethernet	Manage Ethernet interfaces and virtual Ethernet interfaces.
	PPP	Create and manage PPPoE and PPTP interfaces.
	Cellular	Configure a cellular Internet connection for an installed 3G card.
	WLAN	(For USG 20W only) Configure settings for an installed wireless LAN card.
	VLAN	Create and manage VLAN interfaces and virtual VLAN interfaces.
	Bridge	Create and manage bridges and virtual bridge interfaces.
	Trunk	Create and manage trunks (groups of interfaces) for load balancing and link High Availability (HA).
Routing	Policy Route	Create and manage routing policies.
	Static Route	Create and manage IP static routing information.
	RIP	Configure device-level RIP settings.
	OSPF	Configure device-level OSPF settings, including areas and virtual links.
Zone		Configure zones used to define various policies.
DDNS	Profile	Define and manage the ZyWALL's DDNS domain names.
NAT		Set up and manage port forwarding rules.
HTTP Redirect		Set up and manage HTTP redirection rules.
ALG		Configure SIP, H.323, and FTP pass-through settings.
IP/MAC Binding	Summary	Configure IP to MAC address bindings for devices connected to each supported interface.
	Exempt List	Configure ranges of IP addresses to which the ZyWALL does not apply IP/MAC binding.
Auth. Policy		Define rules to force user authentication.
Firewall	Firewall	Create and manage level-3 traffic rules.
	Session Limit	Limit the number of concurrent client NAT/firewall sessions.
VPN		
IPSec VPN	VPN Connection	Configure IPSec tunnels.
	VPN Gateway	Configure IKE tunnels.
SSL VPN	Access Privilege	Configure SSL VPN access rights for users and groups.
	Global Setting	Configure the ZyWALL's SSL VPN settings that apply to all connections.

Table 7 Configuration Menu Screens Summary (continued)

FOLDER OR LINK	TAB	FUNCTION
BWM		
Anti-X		
ADP	General	Display and manage ADP bindings.
	Profile	Create and manage ADP profiles.
Content Filter	General	Create and manage content filter policies.
	Filter Profile	Create and manage the detailed filtering rules for content filtering policies.
Anti-Spam	General	Turn anti-spam on or off and manage anti-spam policies.
	Black/White List	Set up a black list to identify spam and a white list to identify legitimate e-mail.
	DNSBL	Have the ZyWALL check e-mail against DNS Black Lists.
Object		
User/Group	User	Create and manage users.
	Group	Create and manage groups of users.
	Setting	Manage default settings for all users, general settings for user sessions, and rules to force user authentication.
Address	Address	Create and manage host, range, and network (subnet) addresses.
	Address Group	Create and manage groups of addresses.
Service	Service	Create and manage TCP and UDP services.
	Service Group	Create and manage groups of services.
Schedule		Create one-time and recurring schedules.
AAA Server	Active Directory-Default	Configure the default Active Directory settings.
	Active Directory-Group	Create and manage groups of Active Directory servers.
	LDAP-Default	Configure the default LDAP settings.
	LDAP-Group	Create and manage groups of LDAP servers.
	RADIUS-Default	Configure the default RADIUS settings.
	RADIUS-Group	Create and manage groups of RADIUS servers.
Auth. Method		Create and manage ways of authenticating users.
Certificate	My Certificates	Create and manage the ZyWALL's certificates.
	Trusted Certificates	Import and manage certificates from trusted sources.
ISP Account		Create and manage ISP account information for PPPoE/PPTP interfaces.
SSL Application		Create SSL web application objects.

Table 7 Configuration Menu Screens Summary (continued)

FOLDER OR LINK	TAB	FUNCTION
Endpoint Security		Create Endpoint Security (EPS) objects.
System		
Host Name		Configure the system and domain name for the ZyWALL.
USB Storage		Configure the settings for the connected USB devices.
Date/Time		Configure the current date, time, and time zone in the ZyWALL.
Console Speed		Set the console speed.
DNS		Configure the DNS server and address records for the ZyWALL.
WWW	Service Control	Configure HTTP, HTTPS, and general authentication.
	Login Page	Configure how the login and access user screens look.
SSH		Configure SSH server and SSH service settings.
TELNET		Configure telnet server settings for the ZyWALL.
FTP		Configure FTP server settings.
SNMP		Configure SNMP communities and services.
Vantage CNM		Configure and allow your ZyWALL to be managed by the Vantage CNM server.
Language		Select the Web Configurator language.
Log & Report		
Email Daily Report		Configure where and how to send daily reports and what reports to send.
Log Setting		Configure the system log, e-mail logs, and remote syslog servers.

3.3.2.4 Maintenance Menu

Use the maintenance menu screens to manage configuration and firmware files, run diagnostics, and reboot or shut down the ZyWALL.

Table 8 Maintenance Menu Screens Summary

FOLDER OR LINK	TAB	FUNCTION
File Manager	Configuration File	Manage and upload configuration files for the ZyWALL.
	Firmware Package	View the current firmware version and to upload firmware.
	Shell Script	Manage and run shell script files for the ZyWALL.

Table 8 Maintenance Menu Screens Summary (continued)

FOLDER OR LINK	TAB	FUNCTION
Diagnostics	Diagnostic	Collect diagnostic information.
	Packet Capture	Capture packets for analysis.
Packet Flow Explore	Routing Status	View a clear picture on how the ZyWALL determines where to route a packet and check the related settings.
	SNAT Status	View a clear picture on how the ZyWALL converts a packet's source IP address and check the related settings.
Reboot		Restart the ZyWALL.
Shutdown		Turn off the ZyWALL.

3.3.3 Main Window

The main window shows the screen you select in the navigation panel. The main window screens are discussed in the rest of this document.

Right after you log in, the **Dashboard** screen is displayed. See [Chapter 8 on page 165](#) for more information about the **Dashboard** screen.

3.3.3.1 Warning Messages

Warning messages, such as those resulting from misconfiguration, display in a popup window.

Figure 12 Warning Message

3.3.3.2 Site Map

Click **Site MAP** to see an overview of links to the Web Configurator screens. Click a screen's link to go to that screen.

Figure 13 Site Map

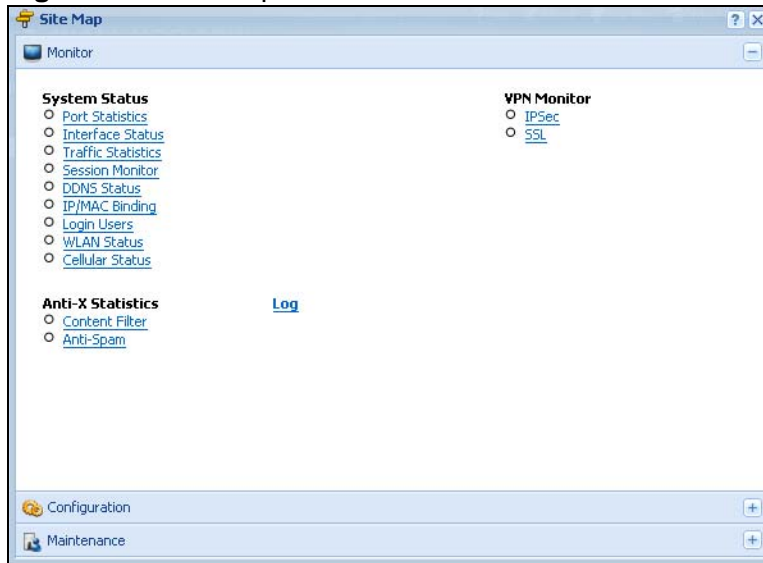

3.3.3.3 Object Reference

Click **Object Reference** to open the **Object Reference** screen. Select the type of object and the individual object and click **Refresh** to show which configuration settings reference the object. The following example shows which configuration settings reference the ldap-users user object (in this case the first firewall rule).

Figure 14 Object Reference

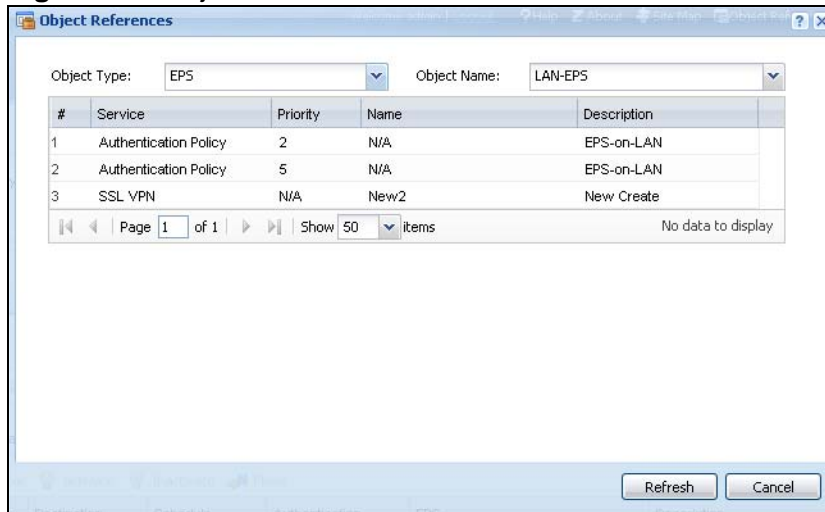

The fields vary with the type of object. The following table describes labels that can appear in this screen.

Table 9 Object References

LABEL	DESCRIPTION
Object Name	This identifies the object for which the configuration settings that use it are displayed. Click the object's name to display the object's configuration screen in the main window.
#	This field is a sequential value, and it is not associated with any entry.
Service	This is the type of setting that references the selected object. Click a service's name to display the service's configuration screen in the main window.
Priority	If it is applicable, this field lists the referencing configuration item's position in its list, otherwise N/A displays.
Name	This field identifies the configuration item that references the object.
Description	If the referencing configuration item has a description configured, it displays here.
Refresh	Click this to update the information in this screen.
Cancel	Click Cancel to close the screen.

3.3.3.4 CLI Messages

Click **CLI** to look at the CLI commands sent by the Web Configurator. These commands appear in a popup window, such as the following.

Figure 15 CLI Messages



Click **Clear** to remove the currently displayed information.

See the Command Reference Guide for information about the commands.

3.3.4 Tables and Lists

The Web Configurator tables and lists are quite flexible and provide several options for how to display their entries.

3.3.4.1 Manipulating Table Display

Here are some of the ways you can manipulate the Web Configurator tables.

- 1 Click a column heading to sort the table's entries according to that column's criteria.

Figure 16 Sorting Table Entries by a Column's Criteria

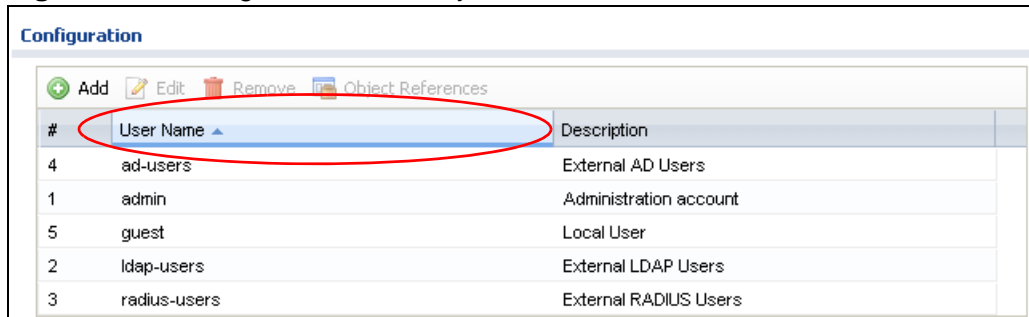

The screenshot shows a table titled 'Configuration' with the following data:

#	User Name	Description
4	ad-users	External AD Users
1	admin	Administration account
5	guest	Local User
2	ldap-users	External LDAP Users
3	radius-users	External RADIUS Users

The 'User Name' column header is highlighted with a red oval, indicating it is the selected sorting criteria.

- 2 Click the down arrow next to a column heading for more options about how to display the entries. The options available vary depending on the type of fields in the column. Here are some examples of what you can do:

- Sort in ascending alphabetical order
- Sort in descending (reverse) alphabetical order
- Select which columns to display
- Group entries by field
- Show entries in groups
- Filter by mathematical operators (<, >, or =) or searching for text

Figure 17 Common Table Column Options

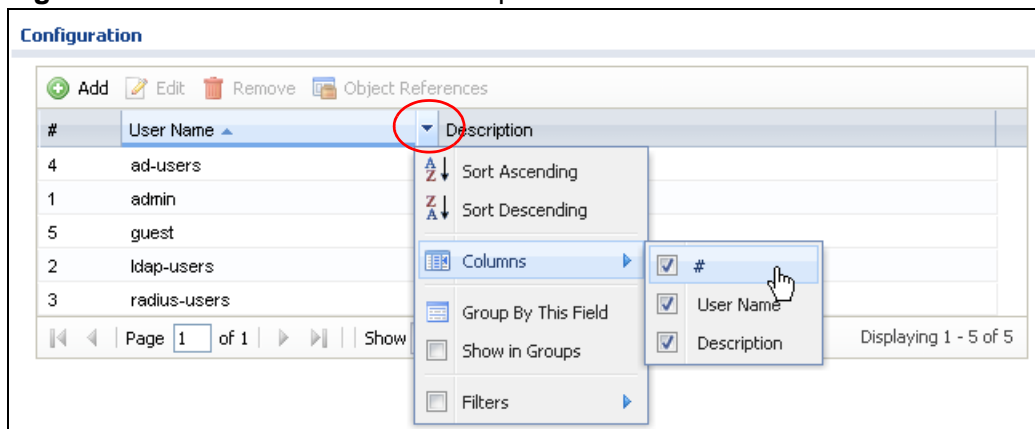

The screenshot shows the 'Configuration' table with the 'Description' column header selected. A context menu is open over the 'Description' header, showing the following options:

- Sort Ascending (A-Z)
- Sort Descending (Z-A)
- Columns (with a sub-menu open showing checkboxes for #, User Name, and Description, all of which are checked)
- Group By This Field
- Show in Groups
- Filters

The 'Columns' sub-menu is highlighted, and a mouse cursor is pointing at the 'User Name' checkbox. The table data is visible in the background, and the status bar at the bottom right indicates 'Displaying 1 - 5 of 5'.

- 3 Select a column heading cell's right border and drag to re-size the column.

Figure 18 Resizing a Table Column

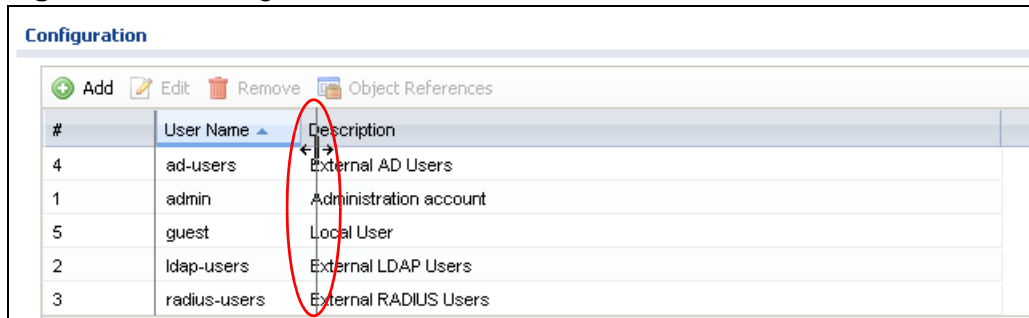

- 4 Select a column heading and drag and drop it to change the column order. A green check mark displays next to the column's title when you drag the column to a valid new location.

Figure 19 Changing the Column Order

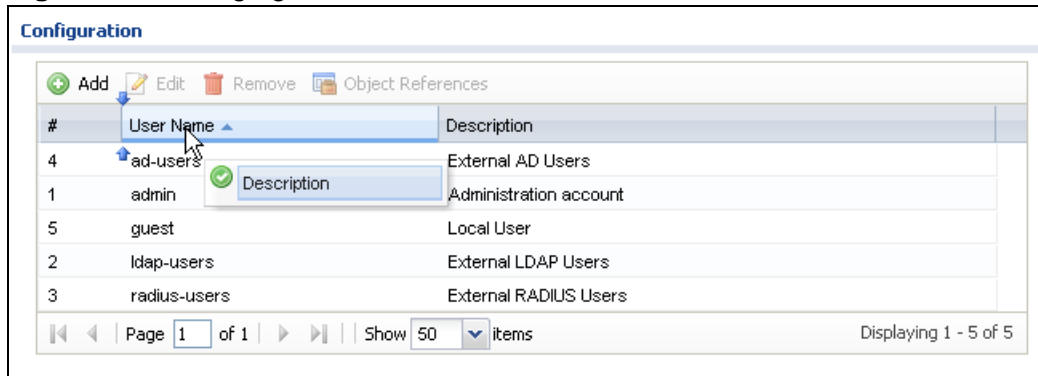

- 5 Use the icons and fields at the bottom of the table to navigate to different pages of entries and control how many entries display at a time.

Figure 20 Navigating Pages of Table Entries

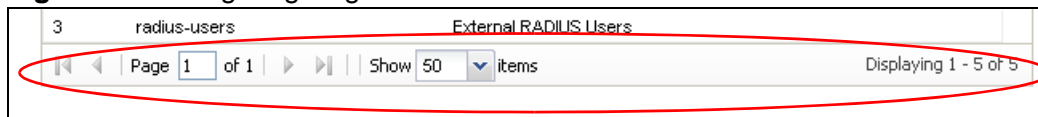

3.3.4.2 Working with Table Entries

The tables have icons for working with table entries. A sample is shown next. You can often use the [Shift] or [Ctrl] key to select multiple entries to remove, activate, or deactivate.

Figure 21 Common Table Icons

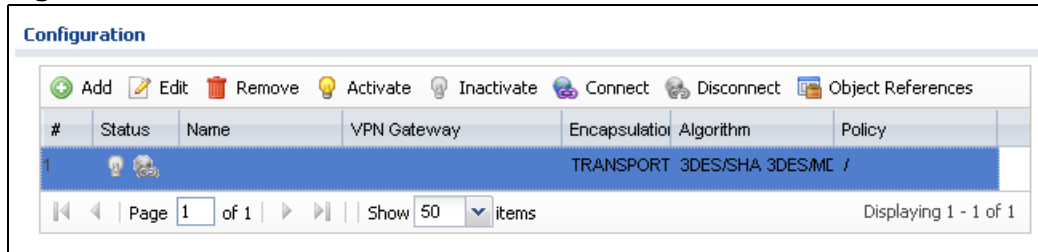

Here are descriptions for the most common table icons.

Table 10 Common Table Icons

LABEL	DESCRIPTION
Add	Click this to create a new entry. For features where the entry's position in the numbered list is important (features where the ZyWALL applies the table's entries in order like the firewall for example), you can select an entry and click Add to create a new entry after the selected entry.
Edit	Double-click an entry or select it and click Edit to open a screen where you can modify the entry's settings. In some tables you can just click a table entry and edit it directly in the table. For those types of tables small red triangles display for table entries with changes that you have not yet applied.
Remove	To remove an entry, select it and click Remove . The ZyWALL confirms you want to remove it before doing so.
Activate	To turn on an entry, select it and click Activate .
Inactivate	To turn off an entry, select it and click Inactivate .
Connect	To connect an entry, select it and click Connect .
Disconnect	To disconnect an entry, select it and click Disconnect .
Object References	Select an entry and click Object References to open a screen that shows which settings use the entry. See Section 11.3.2 on page 232 for an example.
Move	To change an entry's position in a numbered list, select it and click Move to display a field to type a number for where you want to put that entry and press [ENTER] to move the entry to the number that you typed. For example, if you type 6, the entry you are moving becomes number 6 and the previous entry 6 (if there is one) gets pushed up (or down) one.

3.3.4.3 Working with Lists

When a list of available entries displays next to a list of selected entries, you can often just double-click an entry to move it from one list to the other. In some lists

you can also use the [Shift] or [Ctrl] key to select multiple entries, and then use the arrow button to move them to the other list.

Figure 22 Working with Lists

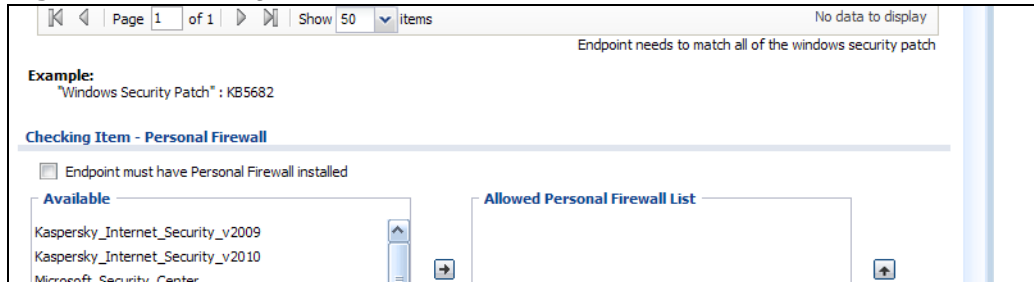

Installation Setup Wizard

4.1 Installation Setup Wizard Screens

If you log into the Web Configurator when the ZyWALL is using its default configuration, the first **Installation Setup Wizard** screen displays. This wizard helps you configure Internet connection settings and activate subscription services. This chapter provides information on configuring the Web Configurator's installation setup wizard. See the feature-specific chapters in this User's Guide for background information.

Figure 23 Installation Setup Wizard



- Click the double arrow in the upper right corner to display or hide the help.
- Click **Go to Dashboard** to skip the installation setup wizard or click **Next** to start configuring for Internet access.

4.1.1 Internet Access Setup - WAN Interface

Use this screen to configure the WAN interface's type of encapsulation and method of IP address assignment.

The screens vary depending on the encapsulation type. Refer to information provided by your ISP to know what to enter in each field. Leave a field blank if you don't have that information.

Note: Enter the Internet access information exactly as your ISP gave it to you.

Figure 24 Internet Access: Step 1

The screenshot shows a web-based configuration interface for 'Internet Access - First WAN Interface'. At the top, there is a breadcrumb trail: 'Internet Access > Internet Access Succeed > Device Registration'. Below this, three numbered steps are visible: 1 (selected), 2, and 3. The main content area is titled 'Internet Access - First WAN Interface' and is divided into two sections: 'ISP Parameters' and 'WAN IP Address Assignments'. Under 'ISP Parameters', the 'Encapsulation' dropdown menu is set to 'Ethernet'. Under 'WAN IP Address Assignments', the 'First WAN Interface' is set to 'wan1', the 'Zone' is set to 'WAN', and the 'IP Address Assignment' dropdown menu is set to 'Auto'. At the bottom right of the form, there are '< Back' and 'Next >' buttons.

- **Encapsulation:** Choose the **Ethernet** option when the WAN port is used as a regular Ethernet. Otherwise, choose **PPPoE** or **PPTP** for a dial-up connection according to the information from your ISP.
- **WAN Interface:** This is the interface you are configuring for Internet access.
- **Zone:** This is the security zone to which this interface and Internet connection belong.
- **IP Address Assignment:** Select **Auto** if your ISP did not assign you a fixed IP address. Select **Static** if the ISP assigned a fixed IP address.

4.1.2 Internet Access: Ethernet

This screen is read-only if you set the previous screen's **IP Address Assignment** field to **Auto**. Use this screen to configure your IP address settings.

Note: Enter the Internet access information exactly as given to you by your ISP.

Figure 25 Internet Access: Ethernet Encapsulation

- **Encapsulation:** This displays the type of Internet connection you are configuring.
- **First WAN Interface:** This is the number of the interface that will connect with your ISP.
- **Zone:** This is the security zone to which this interface and Internet connection will belong.

- **IP Address:** Enter your (static) public IP address. **Auto** displays if you selected **Auto** as the **IP Address Assignment** in the previous screen.

The following fields display if you selected static IP address assignment.

- **IP Subnet Mask:** Enter the subnet mask for this WAN connection's IP address.
- **Gateway IP Address:** Enter the IP address of the router through which this WAN connection will send traffic (the default gateway).
- **First / Second DNS Server:** These fields display if you selected static IP address assignment. The Domain Name System (DNS) maps a domain name to an IP address and vice versa. Enter a DNS server's IP address(es). The DNS server is extremely important because without it, you must know the IP address of a computer before you can access it. The ZyWALL uses these (in the order you specify here) to resolve domain names for VPN, DDNS and the time server. Leave the field as 0.0.0.0 if you do not want to configure DNS servers.

4.1.3 Internet Access: PPPoE

Note: Enter the Internet access information exactly as given to you by your ISP.

Figure 26 Internet Access: PPPoE Encapsulation

The screenshot shows the 'Internet Access - First WAN Interface' configuration window. It is divided into two main sections: 'ISP Parameters' and 'WAN IP Address Assignments'. In the 'ISP Parameters' section, 'Encapsulation' is set to 'PPPoE'. 'Service Name' is an empty text field with '(Optional)' next to it. 'Authentication Type' is a dropdown menu set to 'Chap/PAP'. 'User Name', 'Password', and 'Retype to Confirm' are text fields with red dashed lines and red exclamation mark icons indicating they are required. There is an unchecked checkbox for 'Nailed-Up' and an 'Idle Timeout' field set to '100' with '(Seconds)' next to it. The 'WAN IP Address Assignments' section shows 'First WAN Interface' as 'wan1_ppp', 'Zone' as 'WAN', 'IP Address' as '10.10.0.10', 'First DNS Server' as '10.0.0.3', and 'Second DNS Server' as '10.0.0.4'. At the bottom right, there are '< Back' and 'Next >' buttons.

4.1.3.1 ISP Parameters

- Type the PPPoE **Service Name** from your service provider. PPPoE uses a service name to identify and reach the PPPoE server. You can use alphanumeric and - _@\$./ characters, and it can be up to 64 characters long.
- **Authentication Type** - Select an authentication protocol for outgoing connection requests. Options are:

- **CHAP/PAP** - Your ZyWALL accepts either CHAP or PAP when requested by the remote node.
- **CHAP** - Your ZyWALL accepts CHAP only.
- **PAP** - Your ZyWALL accepts PAP only.
- **MSCHAP** - Your ZyWALL accepts MSCHAP only.
- **MSCHAP-V2** - Your ZyWALL accepts MSCHAP-V2 only.
- Type the **User Name** given to you by your ISP. You can use alphanumeric and -_@\$. / characters, and it can be up to 31 characters long.
- Type the **Password** associated with the user name. Use up to 64 ASCII characters except the [] and ?. This field can be blank.
- Select **Nailed-Up** if you do not want the connection to time out. Otherwise, type the **Idle Timeout** in seconds that elapses before the router automatically disconnects from the PPPoE server.

4.1.3.2 WAN IP Address Assignments

- **WAN Interface:** This is the name of the interface that will connect with your ISP.
- **Zone:** This is the security zone to which this interface and Internet connection will belong.
- **IP Address:** Enter your (static) public IP address. **Auto** displays if you selected **Auto** as the **IP Address Assignment** in the previous screen.
- **First / Second DNS Server:** These fields display if you selected static IP address assignment. The Domain Name System (DNS) maps a domain name to an IP address and vice versa. Enter a DNS server's IP address(es). The DNS server is extremely important because without it, you must know the IP address of a computer before you can access it. The ZyWALL uses these (in the order you specify here) to resolve domain names for VPN, DDNS and the time server. Leave the field as 0.0.0.0 if you do not want to configure DNS servers. If you do not configure a DNS server, you must know the IP address of a machine in order to access it.

4.1.4 Internet Access: PPTP

Note: Enter the Internet access information exactly as given to you by your ISP.

Figure 27 Internet Access: PPTP Encapsulation

Internet Access - First WAN Interface

ISP Parameters

Encapsulation:: PPTP

Authentication Type: Chap/PAP

User Name: [Red dashed box with error icon]

Password: [Red dashed box with error icon]

Retype to Confirm: [Red dashed box with error icon]

Nailed-Up

Idle Timeout: 100 (Seconds)

PPTP Configuration

Base Interface: wan1

Base IP Address: 0.0.0.0 [Red dashed box with error icon]

IP Subnet Mask: 255.255.255.0

Server IP: 0.0.0.0 [Red dashed box with error icon] Address

Connection ID: [Red dashed box with error icon] (Optional)

WAN IP Address Assignments

First WAN Interface: wan1_ppp

Zone: WAN

IP Address: 0.0.0.0 [Red dashed box with error icon]

First DNS Server: [Red dashed box with error icon]

Second DNS Server: [Red dashed box with error icon]

Back Next

4.1.5 ISP Parameters

- **Authentication Type** - Select an authentication protocol for outgoing calls. Options are:
 - **CHAP/PAP** - Your ZyWALL accepts either CHAP or PAP when requested by the remote node.
 - **CHAP** - Your ZyWALL accepts CHAP only.
 - **PAP** - Your ZyWALL accepts PAP only.
 - **MSCHAP** - Your ZyWALL accepts MSCHAP only.
 - **MSCHAP-V2** - Your ZyWALL accepts MSCHAP-V2 only.
- Type the **User Name** given to you by your ISP. You can use alphanumeric and -_@\$./ characters, and it can be up to 31 characters long.
- Type the **Password** associated with the user name. Use up to 64 ASCII characters except the [] and ?. This field can be blank. Re-type your password in the next field to confirm it.

- Select **Nailed-Up** if you do not want the connection to time out. Otherwise, type the **Idle Timeout** in seconds that elapses before the router automatically disconnects from the PPTP server.

4.1.5.1 PPTP Configuration

- **Base Interface:** This identifies the Ethernet interface you configure to connect with a modem or router.
- Type a **Base IP Address** (static) assigned to you by your ISP.
- Type the **IP Subnet Mask** assigned to you by your ISP (if given).
- **Server IP:** Type the IP address of the PPTP server.
- Type a **Connection ID** or connection name. It must follow the "c:id" and "n:name" format. For example, C:12 or N:My ISP. This field is optional and depends on the requirements of your broadband modem or router. You can use alphanumeric and -_ : characters, and it can be up to 31 characters long.

4.1.5.2 WAN IP Address Assignments

- **First WAN Interface:** This is the connection type on the interface you are configuring to connect with your ISP.
- **Zone** This is the security zone to which this interface and Internet connection will belong.
- **IP Address:** Enter your (static) public IP address. Auto displays if you selected **Auto** as the **IP Address Assignment** in the previous screen.
- **First / Second DNS Server:** These fields display if you selected static IP address assignment. The Domain Name System (DNS) maps a domain name to an IP address and vice versa. Enter a DNS server's IP address(es). The DNS server is extremely important because without it, you must know the IP address of a computer before you can access it. The ZyWALL uses these (in the order you specify here) to resolve domain names for VPN, DDNS and the time server. Leave the field as 0.0.0.0 if you do not want to configure DNS servers.

4.1.6 Internet Access - Finish

You have set up your ZyWALL to access the Internet. After configuring the WAN interface, a screen displays with your settings. If they are not correct, click **Back**.

Figure 28 Internet Access: Ethernet Encapsulation

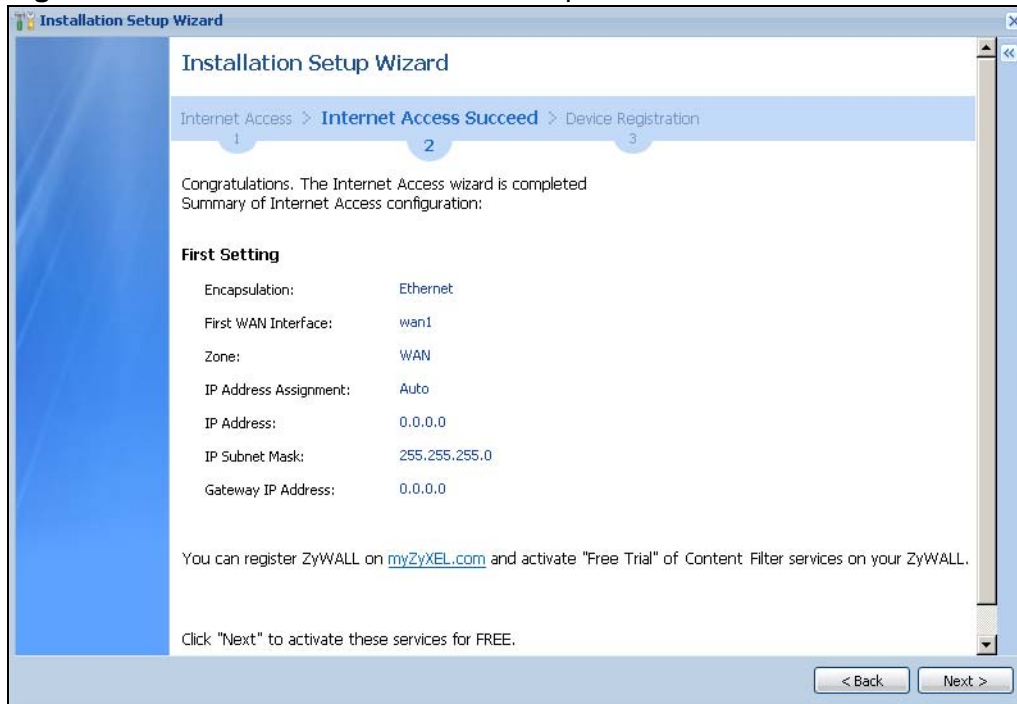

Note: If you have not already done so, you can register your ZyWALL with myZyXEL.com and activate trials of services like Content Filter.

Click **Next** and use the following screen to perform a basic registration (see [Section 4.2 on page 65](#)). If you want to do a more detailed registration or manage your account details, click myZyXEL.com.

Alternatively, close the window to exit the wizard.

4.2 Device Registration

Use this screen to register your ZyWALL with myZyXEL.com and activate trial periods of subscription security features if you have not already done so. If the ZyWALL is already registered this screen displays your user name and which trial services are activated (if any). You can still activate any un-activated trial services.

Note: You must be connected to the Internet to register.

Use the **Registration > Service** screen to update your service subscription status.

Figure 29 Registration

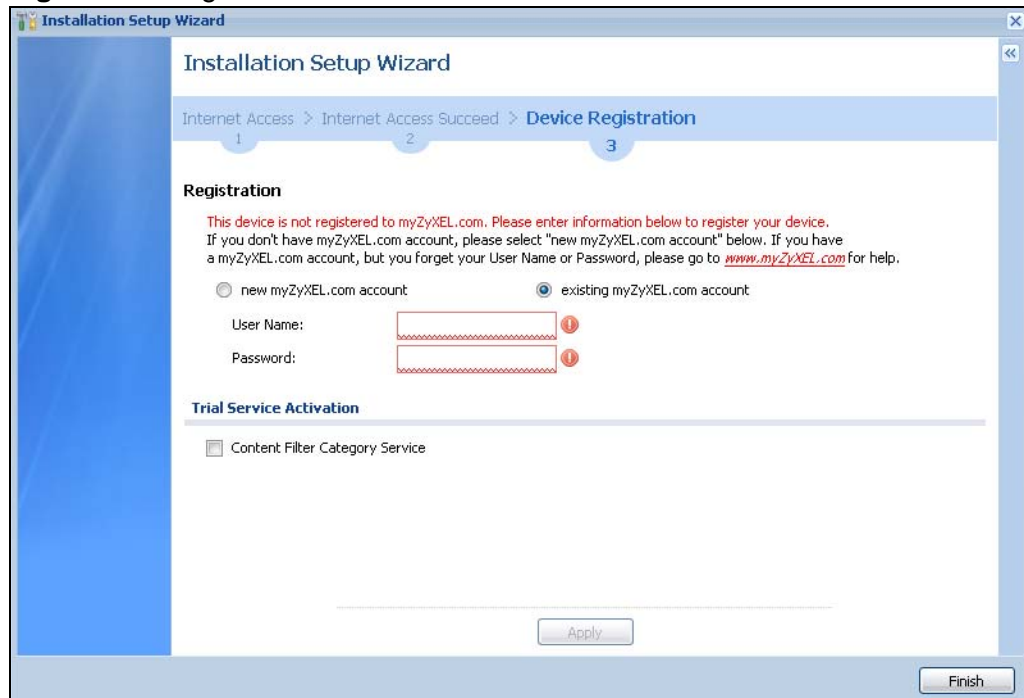

- Select **new myZyXEL.com account** if you haven't created an account at myZyXEL.com, select this option and configure the following fields to create an account and register your ZyWALL.
- Select **existing myZyXEL.com account** if you already have an account at myZyXEL.com and enter your user name and password in the fields below to register your ZyWALL.
- Enter a **User Name** for your myZyXEL.com account. Use from six to 20 alphanumeric characters (and the underscore). Spaces are not allowed. Click **Check** to verify that it is available.
- **Password:** Use six to 20 alphanumeric characters (and the underscore). Spaces are not allowed. Type it again in the **Confirm Password** field.
- **E-Mail Address:** Enter your e-mail address. Use up to 80 alphanumeric characters (periods and the underscore are also allowed) without spaces.
- **Country Code:** Select your country from the drop-down box list.

- **Trial Service Activation:** You can try a trial service subscription. The trial period starts the day you activate the trial. After the trial expires, you can buy an iCard and enter the license key in the **Registration > Service** screen to extend the service.

Figure 30 Registrar: Registered Device

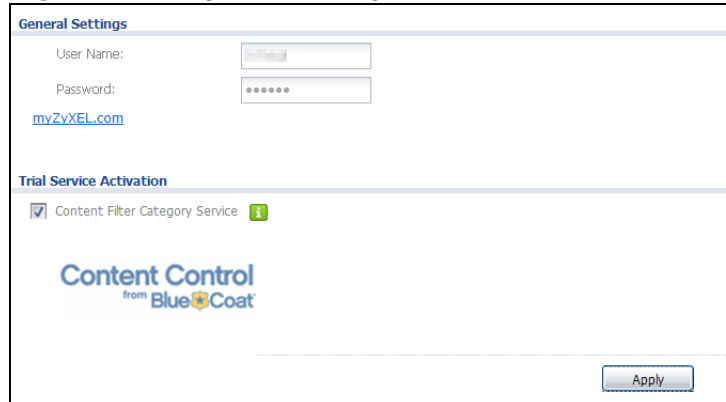

The screenshot shows a web interface for configuring a registered device. It is divided into two main sections: "General Settings" and "Trial Service Activation".

General Settings:

- Contains two input fields: "User Name:" and "Password:". The "User Name" field has a small icon to its right, and the "Password" field has a masked password (dots).
- Below the password field is a blue hyperlink: mvZyXEL.com.

Trial Service Activation:

- Contains a checked checkbox labeled "Content Filter Category Service" followed by a green information icon (i).
- Below this is the logo for "Content Control from Blue Coat".
- At the bottom right of the section is an "Apply" button.

Quick Setup

5.1 Quick Setup Overview

The Web Configurator's quick setup wizards help you configure Internet and VPN connection settings. This chapter provides information on configuring the quick setup screens in the Web Configurator. See the feature-specific chapters in this User's Guide for background information.

In the Web Configurator, click **Configuration > Quick Setup** to open the first **Quick Setup** screen.

Figure 31 Quick Setup



- **WAN Interface**

Click this link to open a wizard to set up a WAN (Internet) connection. This wizard creates matching ISP account settings in the ZyWALL if you use PPPoE or PPTP. See [Section 5.2 on page 70](#).

- **VPN SETUP**

Use **VPN SETUP** to configure a VPN (Virtual Private Network) tunnel for a secure connection to another computer or network. See [Section 5.4 on page 76](#).

5.2 WAN Interface Quick Setup

Click **WAN Interface** in the main **Quick Setup** screen to open the **WAN Interface Quick Setup Wizard Welcome** screen. Use these screens to configure an interface to connect to the internet. Click **Next**.

Figure 32 WAN Interface Quick Setup Wizard

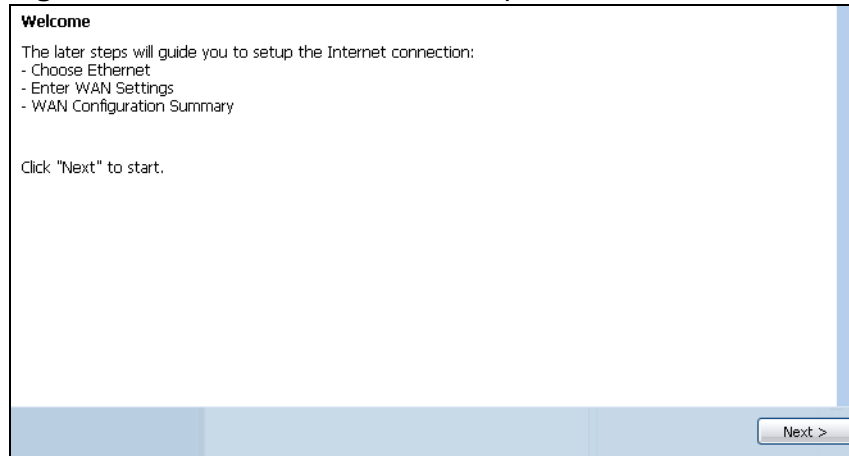

5.2.1 Choose an Ethernet Interface

Select the Ethernet interface that you want to configure for a WAN connection and click **Next**.

Figure 33 Choose an Ethernet Interface

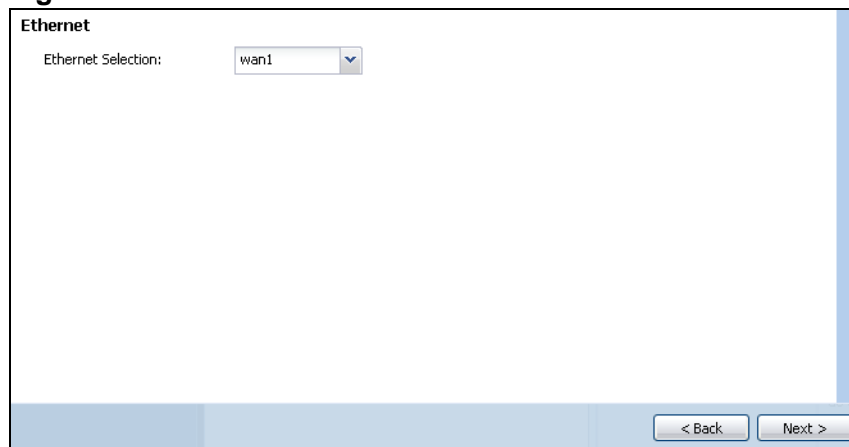

5.2.2 Select WAN Type

WAN Type Selection: Select the type of encapsulation this connection is to use. Choose **Ethernet** when the WAN port is used as a regular Ethernet.

Otherwise, choose **PPPoE** or **PPTP** for a dial-up connection according to the information from your ISP.

Figure 34 WAN Interface Setup: Step 2

The screens vary depending on what encapsulation type you use. Refer to information provided by your ISP to know what to enter in each field. Leave a field blank if you don't have that information.

Note: Enter the Internet access information exactly as your ISP gave it to you.

5.2.3 Configure WAN Settings

Use this screen to select whether the interface should use a fixed or dynamic IP address.

Figure 35 WAN Interface Setup: Step 2

- **WAN Interface:** This is the interface you are configuring for Internet access.
- **Zone:** This is the security zone to which this interface and Internet connection belong.

- **IP Address Assignment:** Select **Auto** If your ISP did not assign you a fixed IP address.
Select **Static** If the ISP assigned a fixed IP address.

5.2.4 WAN and ISP Connection Settings

Use this screen to configure the ISP and WAN interface settings. This screen is read-only if you set the **IP Address Assignment** to **Static**.

Note: Enter the Internet access information exactly as your ISP gave it to you.

Figure 36 WAN and ISP Connection Settings: (PPTP Shown)

The screenshot shows the 'WAN Interface' configuration page. At the top, there are navigation tabs: 'Choose Ethernet', 'Enter WAN Settings', and 'WAN Configuration Summary'. The 'Enter WAN Settings' tab is active and numbered '2'. Below the tabs, the configuration is organized into three main sections:

- ISP Parameters:** Encapsulation is set to PPTP. Authentication Type is a dropdown menu showing 'Chap/PAP'. There are three input fields for 'User Name', 'Password', and 'Retype to Confirm', each with a red error icon. A 'Nailed-Up' checkbox is present. 'Idle Timeout' is set to 100 seconds.
- PPTP Configuration:** 'Base Interface' is 'wan1'. 'Base IP Address' is '0.0.0.0', 'IP Subnet Mask' is '255.255.255.0', and 'Server IP' is '0.0.0.0'. All three IP fields have red error icons. 'Connection ID' is an optional field.
- WAN Interface Setup:** 'WAN Interface' is 'wan1_ppp', 'Zone' is 'WAN', and 'IP Address' is '0.0.0.0'. The IP address field has a red error icon. There are also fields for 'First DNS Server' and 'Second DNS Server'.

At the bottom right, there are '< Back' and 'Next >' buttons.

The following table describes the labels in this screen.

Table 11 WAN and ISP Connection Settings

LABEL	DESCRIPTION
ISP Parameter	This section appears if the interface uses a PPPoE or PPTP Internet connection.
Encapsulation	This displays the type of Internet connection you are configuring.

Table 11 WAN and ISP Connection Settings (continued)

LABEL	DESCRIPTION
Authentication Type	<p>Use the drop-down list box to select an authentication protocol for outgoing calls. Options are:</p> <p>CHAP/PAP - Your ZyWALL accepts either CHAP or PAP when requested by this remote node.</p> <p>CHAP - Your ZyWALL accepts CHAP only.</p> <p>PAP - Your ZyWALL accepts PAP only.</p> <p>MSCHAP - Your ZyWALL accepts MSCHAP only.</p> <p>MSCHAP-V2 - Your ZyWALL accepts MSCHAP-V2 only.</p>
User Name	Type the user name given to you by your ISP. You can use alphanumeric and -_@\$./ characters, and it can be up to 31 characters long.
Password	Type the password associated with the user name above. Use up to 64 ASCII characters except the [] and ?. This field can be blank.
Retype to Confirm	Type your password again for confirmation.
Nailed-Up	Select Nailed-Up if you do not want the connection to time out.
Idle Timeout	Type the time in seconds that elapses before the router automatically disconnects from the PPPoE server. 0 means no timeout.
PPTP Configuration	This section only appears if the interface uses a PPPoE or PPTP Internet connection.
Base Interface	This displays the identity of the Ethernet interface you configure to connect with a modem or router.
Base IP Address	Type the (static) IP address assigned to you by your ISP.
IP Subnet Mask	Type the subnet mask assigned to you by your ISP (if given).
Server IP	Type the IP address of the PPTP server.
Connection ID	<p>Enter the connection ID or connection name in this field. It must follow the "c:id" and "n:name" format. For example, C:12 or N:My ISP.</p> <p>This field is optional and depends on the requirements of your DSL modem.</p> <p>You can use alphanumeric and -_ : characters, and it can be up to 31 characters long.</p>
WAN Interface Setup	
WAN Interface	This displays the identity of the interface you configure to connect with your ISP.
Zone	This field displays to which security zone this interface and Internet connection will belong.
IP Address	This field is read-only when the WAN interface uses a dynamic IP address. If your WAN interface uses a static IP address, enter it in this field.

Table 11 WAN and ISP Connection Settings (continued)

LABEL	DESCRIPTION
First DNS Server Second DNS Server	<p>These fields only display for an interface with a static IP address. Enter the DNS server IP address(es) in the field(s) to the right.</p> <p>Leave the field as 0.0.0.0 if you do not want to configure DNS servers. If you do not configure a DNS server, you must know the IP address of a machine in order to access it.</p> <p>DNS (Domain Name System) is for mapping a domain name to its corresponding IP address and vice versa. The DNS server is extremely important because without it, you must know the IP address of a computer before you can access it. The ZyWALL uses a system DNS server (in the order you specify here) to resolve domain names for VPN, DDNS and the time server.</p>
Back	Click Back to return to the previous screen.
Next	Click Next to continue.

5.2.5 Quick Setup Interface Wizard: Summary

This screen displays the WAN interface's settings.

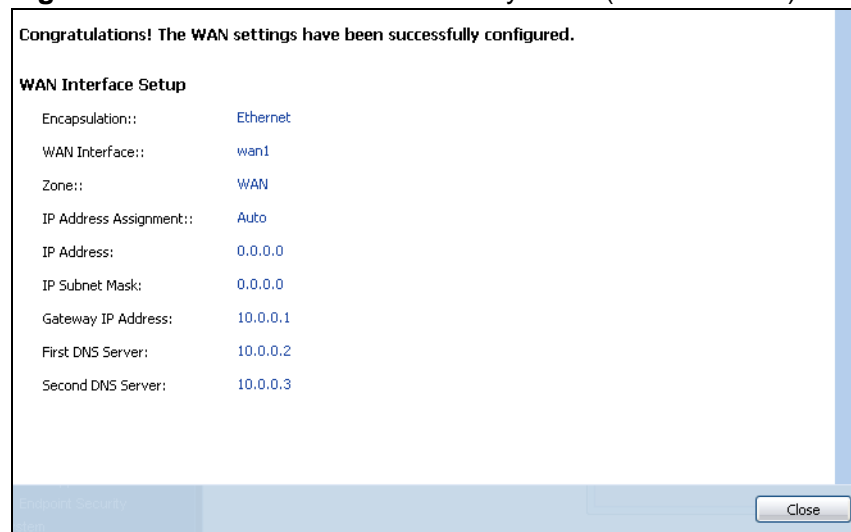
Figure 37 Interface Wizard: Summary WAN (PPTP Shown)

The following table describes the labels in this screen.

Table 12 Interface Wizard: Summary WAN

LABEL	DESCRIPTION
Encapsulation	This displays what encapsulation this interface uses to connect to the Internet.
Service Name	This field is read-only and only appears for a PPPoE interface. It displays the PPPoE service name specified in the ISP account.
Server IP	This field only appears for a PPTP interface. It displays the IP address of the PPTP server.

Table 12 Interface Wizard: Summary WAN

LABEL	DESCRIPTION
User Name	This is the user name given to you by your ISP.
Nailed-Up	If No displays the connection will not time out. Yes means the ZyWALL uses the idle timeout.
Idle Timeout	This is how many seconds the connection can be idle before the router automatically disconnects from the PPPoE server. 0 means no timeout.
Connection ID	If you specified a connection ID, it displays here.
WAN Interface	This identifies the interface you configure to connect with your ISP.
Zone	This field displays to which security zone this interface and Internet connection will belong.
IP Address Assignment	This field displays whether the WAN IP address is static or dynamic (Auto).
First DNS Server	If the IP Address Assignment is Static , these fields display the DNS server IP address(es).
Second DNS Server	
Close	Click Close to exit the wizard.

5.3 VPN Quick Setup

Click **VPN Setup** in the main **Quick Setup** screen to open the **VPN Setup Wizard Welcome** screen. The VPN wizard creates corresponding VPN connection and VPN gateway settings and address objects that you can use later in configuring more VPN connections or other features. Click **Next**.

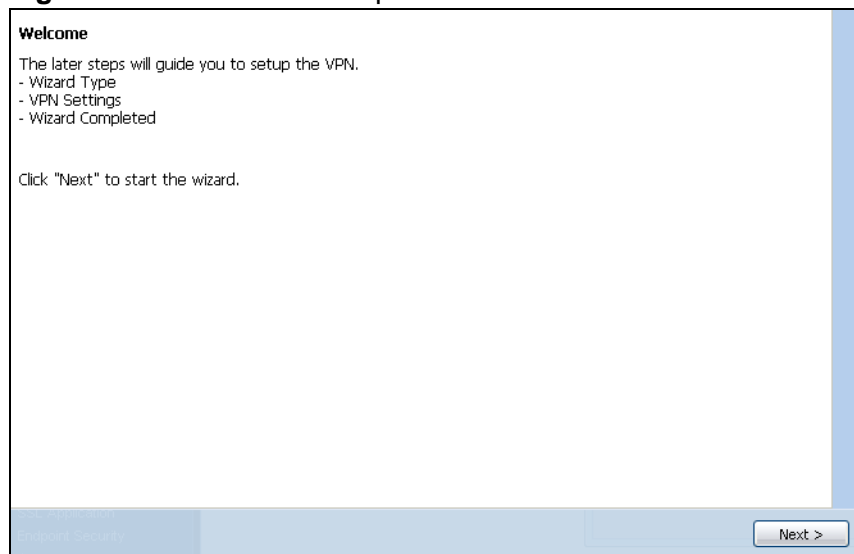
Figure 38 VPN Quick Setup Wizard

5.4 VPN Setup Wizard: Wizard Type

A VPN (Virtual Private Network) tunnel is a secure connection to another computer or network. Use this screen to select which type of VPN connection you want to configure.

Figure 39 VPN Setup Wizard: Wizard Type

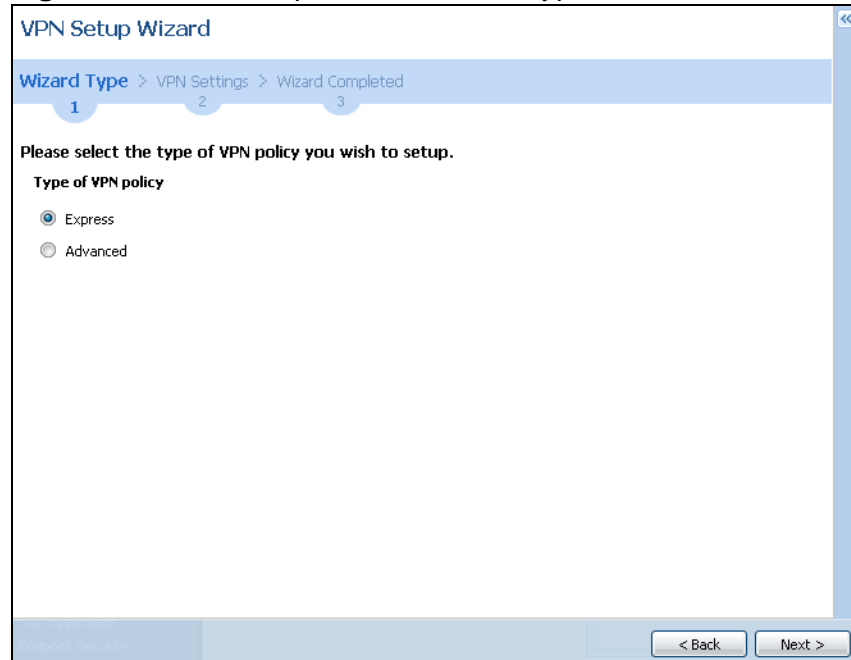

Express: Use this wizard to create a VPN connection with another ZLD-based ZyWALL using a pre-shared key and default security settings.

Advanced: Use this wizard to configure detailed VPN security settings such as using certificates. The VPN connection can be to another ZLD-based ZyWALL or other IPSec device.

5.5 VPN Express Wizard - Scenario

Click the **Express** radio button as shown in [Figure 39 on page 76](#) to display the following screen.

Figure 40 VPN Express Wizard: Step 2

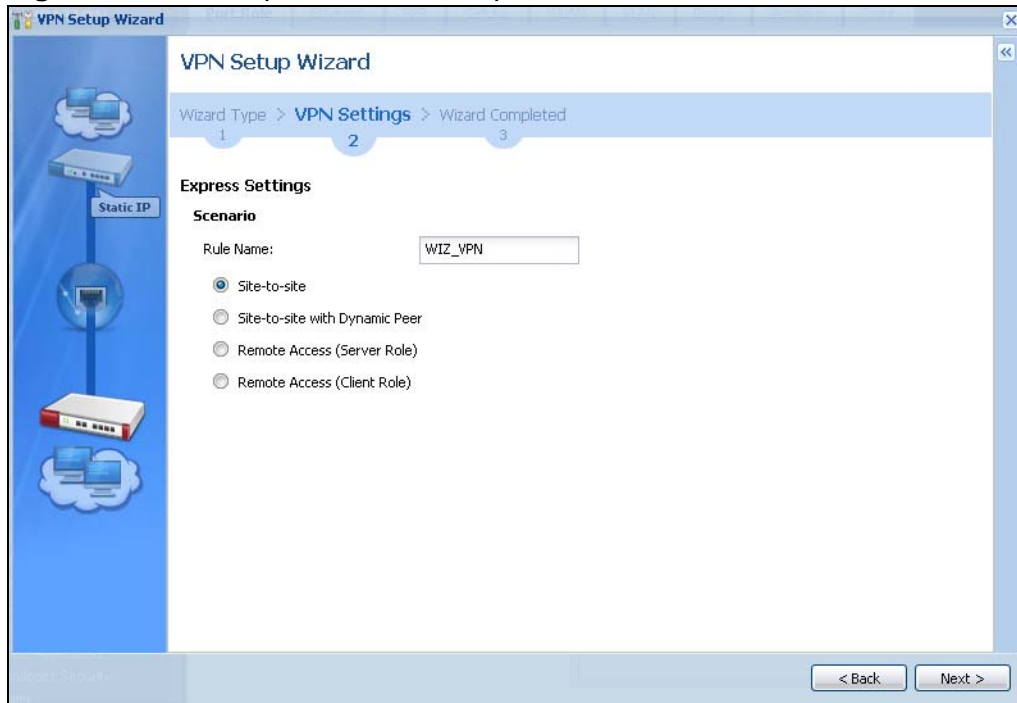

Rule Name: Type the name used to identify this VPN connection (and VPN gateway). You may use 1-31 alphanumeric characters, underscores (_), or dashes (-), but the first character cannot be a number. This value is case-sensitive.

Select the scenario that best describes your intended VPN connection. The figure on the left of the screen changes to match the scenario you select.

- **Site-to-site** - Choose this if the remote IPsec device has a static IP address or a domain name. This ZyWALL can initiate the VPN tunnel.
- **Site-to-site with Dynamic Peer** - Choose this if the remote IPsec device has a dynamic IP address. Only the remote IPsec device can initiate the VPN tunnel.
- **Remote Access (Server Role)** - Choose this to allow incoming connections from IPsec VPN clients. The clients have dynamic IP addresses and are also known as dial-in users. Only the clients can initiate the VPN tunnel.
- **Remote Access (Client Role)** - Choose this to connect to an IPsec server. This ZyWALL is the client (dial-in user) and can initiate the VPN tunnel.

5.5.1 VPN Express Wizard - Configuration

Figure 41 VPN Express Wizard: Step 3

- **Secure Gateway:** If **Any** displays in this field, it is not configurable for the chosen scenario. If this field is configurable, enter the WAN IP address or domain name of the remote IPsec device (secure gateway) to identify the remote IPsec router by its IP address or a domain name. Use 0.0.0.0 if the remote IPsec router has a dynamic WAN IP address.
- **Pre-Shared Key:** Type the password. Both ends of the VPN tunnel must use the same password. Use 8 to 31 case-sensitive ASCII characters or 8 to 31 pairs of hexadecimal ("0-9", "A-F") characters. Proceed a hexadecimal key with "0x". You will receive a PYLD_MALFORMED (payload malformed) packet if the same pre-shared key is not used on both ends.
- **Local Policy (IP/Mask):** Type the IP address of a computer on your network. You can also specify a subnet. This must match the remote IP address configured on the remote IPsec device.
- **Remote Policy (IP/Mask):** If **Any** displays in this field, it is not configurable for the chosen scenario. If this field is configurable, type the IP address of a computer behind the remote IPsec device. You can also specify a subnet. This must match the local IP address configured on the remote IPsec device.

5.5.2 VPN Express Wizard - Summary

This screen provides a read-only summary of the VPN tunnel's configuration and also commands that you can copy and paste into another ZLD-based ZyWALL's command line interface to configure it.

Figure 42 VPN Express Wizard: Step 4

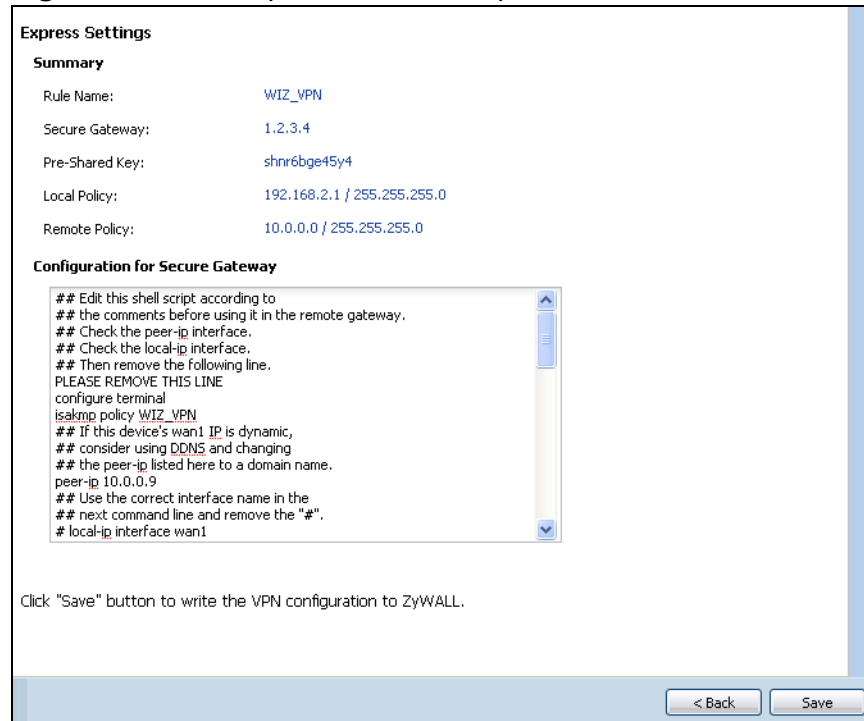

- **Rule Name:** Identifies the VPN gateway policy.
- **Secure Gateway:** IP address or domain name of the remote IPSec device. If this field displays **Any**, only the remote IPSec device can initiate the VPN connection.
- **Pre-Shared Key:** VPN tunnel password. It identifies a communicating party during a phase 1 IKE negotiation.
- **Local Policy:** (Static) IP address and subnet mask of the computers on the network behind your ZyWALL that can use the tunnel.
- **Remote Policy:** (Static) IP address and subnet mask of the computers on the network behind the remote IPSec device that can use the tunnel. If this field displays **Any**, only the remote IPSec device can initiate the VPN connection.
- Copy and paste the **Configuration for Secure Gateway** commands into another ZLD-based ZyWALL's command line interface to configure it to serve as the other end of this VPN tunnel. You can also use a text editor to save these commands as a shell script file with a ".zysh" filename extension. Then you can use the file manager to run the script in order to configure the VPN connection. See the commands reference guide for details on the commands displayed in this list.

5.5.3 VPN Express Wizard - Finish

Now you can use the VPN tunnel.

Figure 43 VPN Express Wizard: Step 6

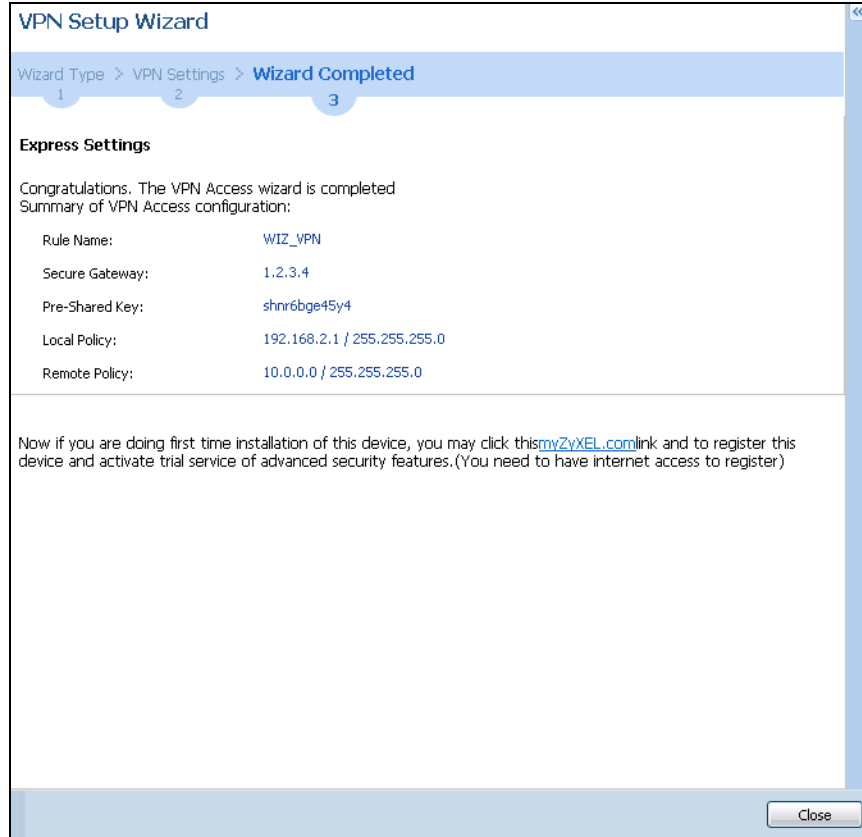

Note: If you have not already done so, use the myZyXEL.com link and register your ZyWALL with myZyXEL.com and activate trials of services like Content Filter.

Click **Close** to exit the wizard.

5.5.4 VPN Advanced Wizard - Scenario

Click the **Advanced** radio button as shown in [Figure 39 on page 76](#) to display the following screen.

Figure 44 VPN Advanced Wizard: Scenario

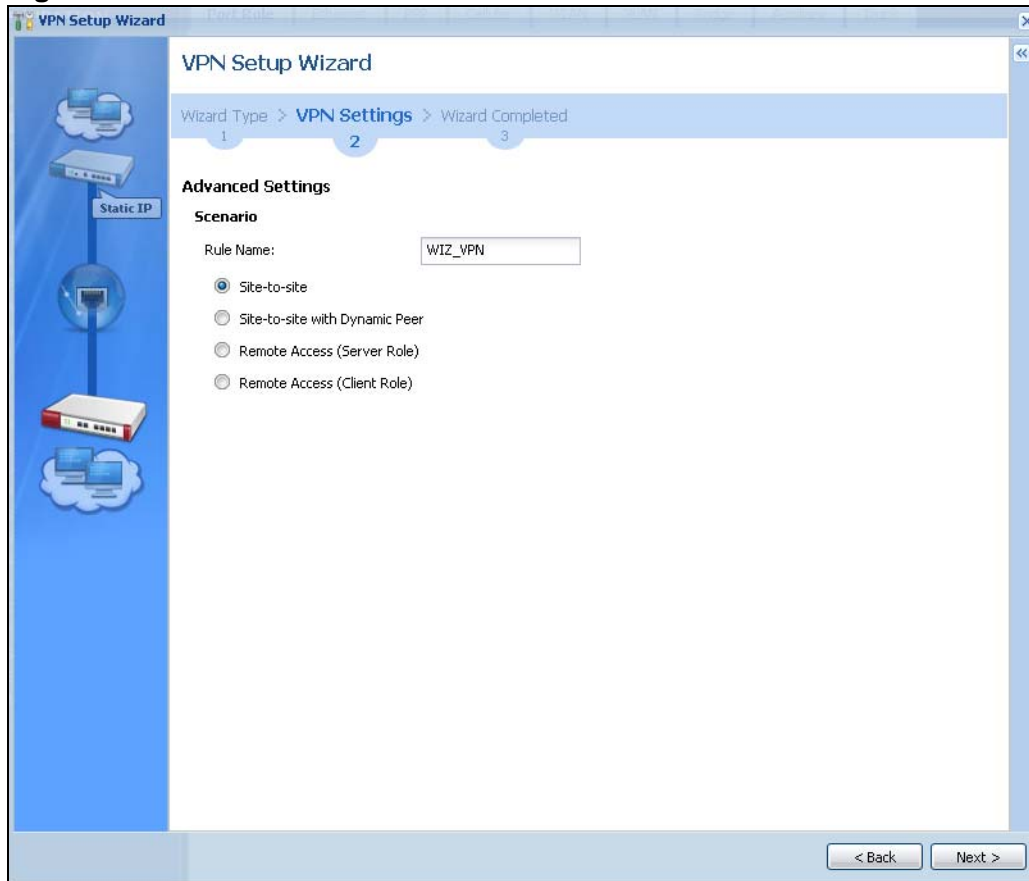

Rule Name: Type the name used to identify this VPN connection (and VPN gateway). You may use 1-31 alphanumeric characters, underscores (_), or dashes (-), but the first character cannot be a number. This value is case-sensitive.

Select the scenario that best describes your intended VPN connection. The figure on the left of the screen changes to match the scenario you select.

- **Site-to-site** - Choose this if the remote IPSec device has a static IP address or a domain name. This ZyWALL can initiate the VPN tunnel.
- **Site-to-site with Dynamic Peer** - Choose this if the remote IPSec device has a dynamic IP address. Only the remote IPSec device can initiate the VPN tunnel.
- **Remote Access (Server Role)** - Choose this to allow incoming connections from IPSec VPN clients. The clients have dynamic IP addresses and are also known as dial-in users. Only the clients can initiate the VPN tunnel.

- Remote Access (Client Role) - Choose this to connect to an IPSec server. This ZyWALL is the client (dial-in user) and can initiate the VPN tunnel.

5.5.5 VPN Advanced Wizard - Phase 1 Settings

There are two phases to every IKE (Internet Key Exchange) negotiation – phase 1 (Authentication) and phase 2 (Key Exchange). A phase 1 exchange establishes an IKE SA (Security Association).

Figure 45 VPN Advanced Wizard: Phase 1 Settings

- **Secure Gateway:** If **Any** displays in this field, it is not configurable for the chosen scenario. If this field is configurable, enter the WAN IP address or domain name of the remote IPSec device (secure gateway) to identify the remote IPSec device by its IP address or a domain name. Use 0.0.0.0 if the remote IPSec device has a dynamic WAN IP address.
- **My Address (interface):** Select an interface from the drop-down list box to use on your ZyWALL.
- **Negotiation Mode:** Select **Main** for identity protection. Select **Aggressive** to allow more incoming connections from dynamic IP addresses to use separate passwords.

Note: Multiple SAs connecting through a secure gateway must have the same negotiation mode.

- **Encryption Algorithm:** **3DES** and **AES** use encryption. The longer the key, the higher the security (this may affect throughput). Both sender and receiver must know the same secret key, which can be used to encrypt and decrypt the message or to generate and verify a message authentication code. The DES encryption algorithm uses a 56-bit key. Triple DES (3DES) is a variation on DES

that uses a 168-bit key. As a result, 3DES is more secure than DES. It also requires more processing power, resulting in increased latency and decreased throughput. AES128 uses a 128-bit key and is faster than 3DES. AES192 uses a 192-bit key and AES256 uses a 256-bit key.

- **Authentication Algorithm:** **MD5** gives minimal security. **SHA-1** gives higher security. MD5 (Message Digest 5) and SHA1 (Secure Hash Algorithm) are hash algorithms used to authenticate packet data. The SHA1 algorithm is generally considered stronger than MD5, but is slower.
- **Key Group:** **DH5** is more secure than **DH1** or **DH2** (although it may affect throughput). DH1 (default) refers to Diffie-Hellman Group 1 a 768 bit random number. DH2 refers to Diffie-Hellman Group 2 a 1024 bit (1Kb) random number. DH5 refers to Diffie-Hellman Group 5 a 1536 bit random number.
- **SA Life Time:** Set how often the ZyWALL renegotiates the IKE SA. A short SA life time increases security, but renegotiation temporarily disconnects the VPN tunnel.
- **NAT Traversal:** Select this if the VPN tunnel must pass through NAT (there is a NAT router between the IPsec devices).

Note: The remote IPsec device must also have NAT traversal enabled. See [VPN, NAT, and NAT Traversal on page 419](#) for more information.

- **Dead Peer Detection (DPD)** has the ZyWALL make sure the remote IPsec device is there before transmitting data through the IKE SA. If there has been no traffic for at least 15 seconds, the ZyWALL sends a message to the remote IPsec device. If it responds, the ZyWALL transmits the data. If it does not respond, the ZyWALL shuts down the IKE SA.
- **Authentication Method:** Select **Pre-Shared Key** to use a password or **Certificate** to use one of the ZyWALL's certificates.

5.5.6 VPN Advanced Wizard - Phase 2

Phase 2 in an IKE uses the SA that was established in phase 1 to negotiate SAs for IPsec.

Figure 46 VPN Advanced Wizard: Step 4

Advanced Settings	
Phase 2 Setting	
Active Protocol:	ESP
Encapsulation:	Tunnel
Encryption Algorithm:	DES
Authentication Algorithm:	SHA1
SA Life Time:	86400 (180 - 3000000 Seconds)
Perfect Forward Secrecy (PFS):	None
Policy Setting	
Local Policy (IP/Mask)	0.0.0.0 / 255.255.255.0
Remote Policy (IP/Mask)	0.0.0.0 / 255.255.255.0
Property	
<input checked="" type="checkbox"/>	Nailed-Up

- **Active Protocol:** **ESP** is compatible with NAT, **AH** is not.
- **Encapsulation:** **Tunnel** is compatible with NAT, **Transport** is not.
- **Encryption Algorithm:** **3DES** and **AES** use encryption. The longer the **AES** key, the higher the security (this may affect throughput). **Null** uses no encryption.
- **Authentication Algorithm:** **MD5** gives minimal security. **SHA-1** gives higher security. MD5 (Message Digest 5) and SHA1 (Secure Hash Algorithm) are hash algorithms used to authenticate packet data. The SHA1 algorithm is generally considered stronger than MD5, but is slower.
- **SA Life Time:** Set how often the ZyWALL renegotiates the IKE SA. A short SA life time increases security, but renegotiation temporarily disconnects the VPN tunnel.
- **Perfect Forward Secrecy (PFS):** Disabling PFS allows faster IPSec setup, but is less secure. Select DH1, DH2 or DH5 to enable PFS. **DH5** is more secure than **DH1** or **DH2** (although it may affect throughput). DH1 refers to Diffie-Hellman Group 1 a 768 bit random number. DH2 refers to Diffie-Hellman Group 2 a 1024 bit (1Kb) random number. DH5 refers to Diffie-Hellman Group 5 a 1536 bit random number (more secure, yet slower).
- **Local Policy (IP/Mask):** Type the IP address of a computer on your network. You can also specify a subnet. This must match the remote IP address configured on the remote IPSec device.
- **Remote Policy (IP/Mask):** Type the IP address of a computer behind the remote IPSec device. You can also specify a subnet. This must match the local IP address configured on the remote IPSec device.
- **Nailed-Up:** This displays for the site-to-site and remote access client role scenarios. Select this to have the ZyWALL automatically renegotiate the IPSec SA when the SA life time expires.

5.5.7 VPN Advanced Wizard - Summary

This is a read-only summary of the VPN tunnel settings.

Figure 47 VPN Advanced Wizard: Step 5

Express Settings

Summary

Rule Name: WIZ_VPN

Secure Gateway: 1.2.3.4

Certificate: default

Local Policy: 0.0.0.0 / 255.255.255.0

Remote Policy: 0.0.0.0 / 255.255.255.0

Configuration for Secure Gateway

```
## Edit this shell script according to
## the comments before using it in the remote gateway.
## Check the peer-ip interface.
## Check the local-ip interface.
## Edit the WIZ_VPN_LOCAL address-object.
## Then remove the following line.
PLEASE REMOVE THIS LINE
configure terminal
isakmp policy WIZ_VPN
## If this device's wan1 IP is dynamic,
## consider using DDNS and changing
## the peer-ip listed here to a domain name.
peer-ip 10.0.0.9
## Use the correct interface name in the
## next command line and remove the "#".
```

Click "Save" button to write the VPN configuration to ZyWALL.

< Back Save

- **Rule Name:** Identifies the VPN connection (and the VPN gateway).
- **Secure Gateway:** IP address or domain name of the remote IPsec device.
- **Pre-Shared Key:** VPN tunnel password.
- **Certificate:** The certificate the ZyWALL uses to identify itself when setting up the VPN tunnel.
- **Local Policy:** IP address and subnet mask of the computers on the network behind your ZyWALL that can use the tunnel.
- **Remote Policy:** IP address and subnet mask of the computers on the network behind the remote IPsec device that can use the tunnel.
- Copy and paste the **Configuration for Remote Gateway** commands into another ZLD-based ZyWALL's command line interface.
- Click **Save** to save the VPN rule.

5.5.8 VPN Advanced Wizard - Finish

Now you can use the VPN tunnel.

Figure 48 VPN Wizard: Step 6: Advanced

Advanced Settings

Congratulations. The VPN Access wizard is completed
Summary of VPN Access configuration:

Rule Name:	WIZ_VPN
Secure Gateway:	1.2.3.4
My Address (interface):	wan1
Pre-Shared Key:	lkj581mjw777

Phase 1

Negotiation Mode:	main
Encryption Algorithm:	des
Authentication Algorithm:	md5
Key Group:	DH1
SA Life Time:	86400
NAT Traversal:	false
Dead Peer Detection (DPD):	true

Phase 2

Active Protocol:	esp
Encapsulation:	tunnel
Encryption Algorithm:	des
Authentication Algorithm:	sha
SA Life Time:	86400
Perfect Forward Secrecy:	None

Policy

Local Policy:	0.0.0.0 / 255.255.255.0
Remote Policy:	0.0.0.0 / 255.255.255.0
Nailed-Up:	true

Now if you are doing first time installation of this device, you may click this myZyXEL.com link and to register this device and activate trial service of advanced security features. (You need to have internet access to register)

Note: If you have not already done so, you can register your ZyWALL with myZyXEL.com and activate trials of services like Content Filter.

Click **Close** to exit the wizard.

Configuration Basics

This information is provided to help you configure the ZyWALL effectively. Some of it is helpful when you are just getting started. Some of it is provided for your reference when you configure various features in the ZyWALL.

- [Section 6.1 on page 87](#) introduces the ZyWALL's object-based configuration.
- [Section 6.2 on page 88](#) introduces zones, interfaces, and port groups.
- [Section 6.3 on page 91](#) introduces some terminology and organization for the ZyWALL.
- [Section 6.4 on page 91](#) covers the ZyWALL's packet flow.
- [Section 6.5 on page 95](#) identifies the features you should configure before and after you configure the main screens for each feature. For example, if you want to configure a trunk for load-balancing, you should configure the member interfaces before you configure the trunk. After you configure the trunk, you should configure a policy route for it as well. (You might also have to configure criteria for the policy route.)
- [Section 6.6 on page 103](#) identifies the objects that store information used by other features.
- [Section 6.7 on page 105](#) introduces some of the tools available for system management.

6.1 Object-based Configuration

The ZyWALL stores information or settings as objects. You use these objects to configure many of the ZyWALL's features and settings. Once you configure an object, you can reuse it in configuring other features.

When you change an object's settings, the ZyWALL automatically updates all the settings or rules that use the object. For example, if you create a schedule object, you can have firewall, content filter, and other settings use it. If you modify the schedule, all the firewall, content filter, and other settings that use the schedule automatically apply the updated schedule.

You can create address objects based on an interface's IP address, subnet, or gateway. The ZyWALL automatically updates every rule or setting that uses these objects whenever the interface's IP address settings change. For example, if you

change an Ethernet interface's IP address, the ZyWALL automatically updates the rules or settings that use the interface-based, LAN subnet address object.

You can use the **Configuration > Objects** screens to create objects before you configure features that use them. If you are in a screen that uses objects, you can also usually select **Create new Object** to be able to configure a new object. For a list of common objects, see [Section 6.6 on page 103](#).

Use the **Object Reference** screen ([Section 3.3.3.3 on page 53](#)) to see what objects are configured and which configuration settings reference specific objects.

6.2 Zones, Interfaces, and Physical Ports

Zones (groups of interfaces and VPN tunnels) simplify security settings. Here is an overview of zones, interfaces, and physical ports in the ZyWALL.

Figure 49

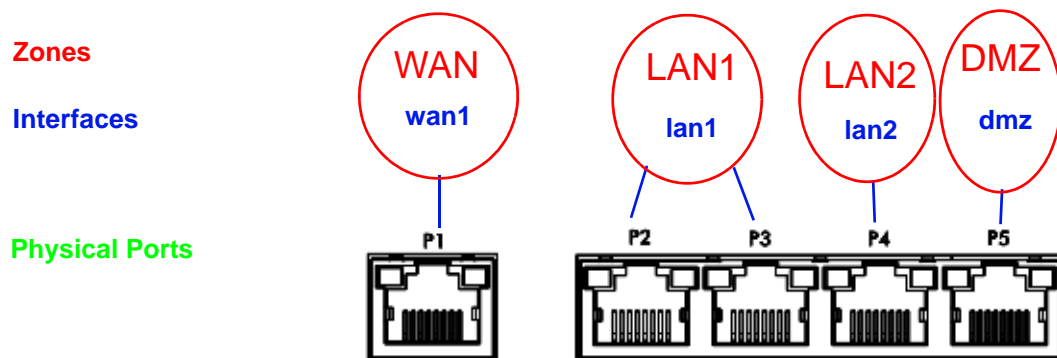

Table 13 Zones, Interfaces, and Physical Ethernet Ports

Zones (WAN, LAN, DMZ)	A zone is a group of interfaces and VPN tunnels. Use zones to apply security settings such as firewall, remote management.
Interfaces (Ethernet, VLAN, ...)	Interfaces are logical entities that (layer-3) packets pass through. Use interfaces in configuring VPN, zones, trunks, DDNS, policy routes, static routes, HTTP redirect, and NAT. Port roles combine physical ports into interfaces.
Physical Ethernet Ports (P1, P2, ...)	The physical port is where you connect a cable. In configuration, you use physical ports when configuring port groups. You use interfaces and zones in configuring other features.

6.2.1 Interface Types

There are many types of interfaces in the ZyWALL. In addition to being used in various features, interfaces also describe the network that is directly connected to the ZyWALL.

- **Ethernet interfaces** are the foundation for defining other interfaces and network policies. You also configure RIP and OSPF in these interfaces.
- **Port groups** create a hardware connection between physical ports at the layer-2 (data link, MAC address) level. Port groups are created when you use the **Interface > Port Roles** screen to set multiple physical ports to be part of the same (lan1, lan2 or dmz) interface.
- **PPP interfaces** support Point-to-Point Protocols (PPPoE or PPTP). ISP accounts are required for PPPoE/PPTP interfaces.
- **VLAN interfaces** recognize tagged frames. The ZyWALL automatically adds or removes the tags as needed. Each VLAN can only be associated with one Ethernet interface.
- **Bridge interfaces** create a software connection between Ethernet or VLAN interfaces at the layer-2 (data link, MAC address) level. Then, you can configure the IP address and subnet mask of the bridge. It is also possible to configure zone-level security between the member interfaces in the bridge.
- **Virtual interfaces** increase the amount of routing information in the ZyWALL. There are three types: **virtual Ethernet interfaces** (also known as IP alias), **virtual VLAN interfaces**, and **virtual bridge interfaces**.

6.2.2 Default Interface and Zone Configuration

This section introduces the ZyWALL's default zone member physical interfaces and the default configuration of those interfaces. The following figure uses letters to denote public IP addresses or part of a private IP address.

Figure 50 Default Network Topology

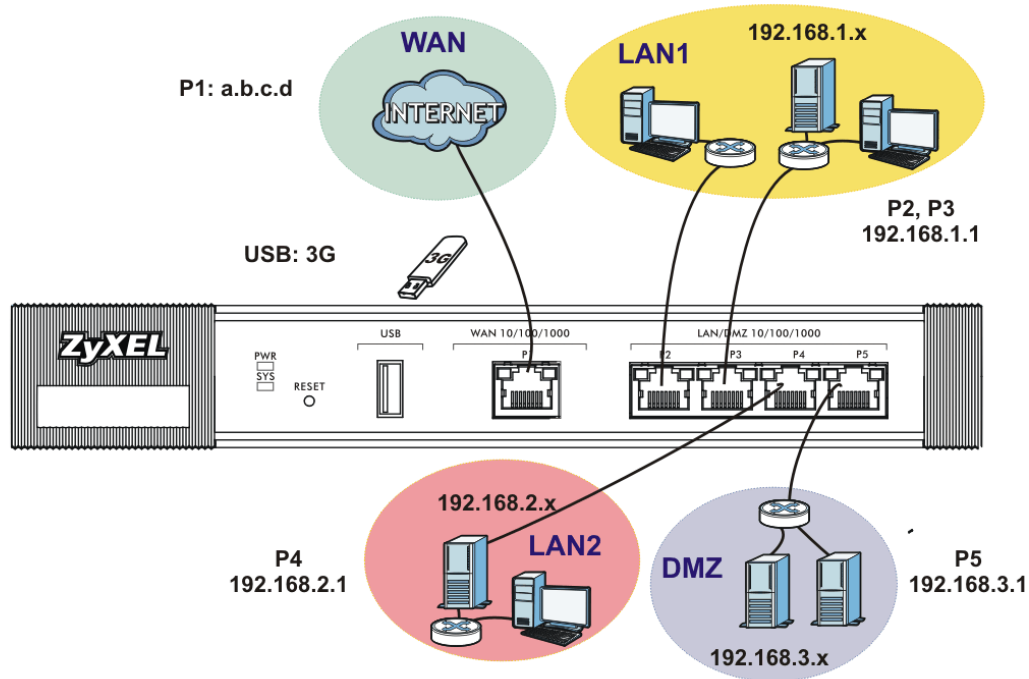

Table 14 ZyWALL USG 20 Default Port, Interface, and Zone Configuration

PORT	INTERFACE	ZONE	IP ADDRESS AND DHCP SETTINGS	SUGGESTED USE WITH DEFAULT SETTINGS
P1	wan1	WAN	DHCP clients	Connections to the Internet
P2, P3	lan1	LAN1	192.168.1.1, DHCP server enabled	Protected LAN
P4	lan2	LAN2	192.168.2.1, DHCP server enabled	Protected LAN
P5	dmz	DMZ	192.168.3.1, DHCP server disabled	Public servers (such as web, e-mail and FTP)
CONSOLE	n/a	None	None	Local management

- The WAN zone contains the **wan1** interface (physical port **P1**). It uses a public IP address to connect to the Internet.
- The LAN1 zone contains the **lan1** interface (a port group made up of physical ports **P2** and **P3** on the ZyWALL). The LAN1 zone is a protected zone. The **lan1** interface uses 192.168.1.1 and the connected devices use IP addresses in the 192.168.1.2 to 192.168.1.254 range.

- The DMZ zone contains the **dmz** interface (physical port **P6**). The DMZ zone has servers that are available to the public. The **dmz** interface uses private IP address 192.168.3.1 and the connected devices use private IP addresses in the 192.168.3.2 to 192.168.3.254 range.

6.3 Terminology in the ZyWALL

This section highlights some terminology or organization for ZLD-based ZyWALLs.

Table 15 ZLD ZyWALL Terminology

FEATURE / TERM	ZLD ZYWALL FEATURE / TERM
IP alias	Virtual interface
Gateway policy	VPN gateway
Network policy (IPSec SA)	VPN connection
Source NAT (SNAT)	Policy route
Trigger port, port triggering	Policy route
Address mapping	Policy route
Address mapping (VPN)	IPSec VPN
Interface bandwidth management (outbound)	Interface
General bandwidth management	Policy route

6.4 Packet Flow

Here is the order in which the ZyWALL applies its features and checks.

Traffic In > Defragmentation > Destination NAT > Routing > Stateful Firewall > ADP > Application Classification > Content Filter > Anti-Spam > SNAT > Bandwidth Management > Fragmentation > Traffic Out.

Figure 51 Packet Flow

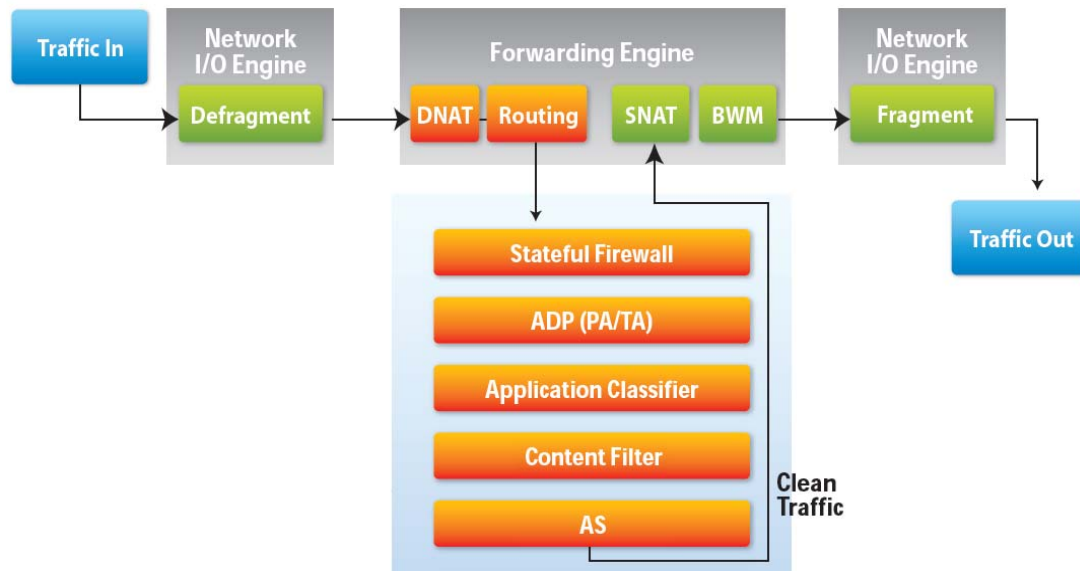

The packet flow is as follows:

- Automatic SNAT and WAN trunk routing for traffic going from internal to external interfaces (you don't need to configure anything to all LAN to WAN traffic).

The ZyWALL automatically adds all of the external interfaces to the default WAN trunk. External interfaces include ppp and cellular interfaces as well as any Ethernet interfaces that are set as external interfaces.

Examples of internal interfaces are any Ethernet interfaces that you configure as internal interfaces.

- A policy route can be automatically disabled if the next-hop is dead.
- You do not need to set up policy routes for IPSec traffic.
- Policy routes can override direct routes.
- You do not need to set up policy routes for 1:1 NAT entries.
- You can create Many 1:1 NAT entries to translate a range of private network addresses to a range of public IP addresses
- Static and dynamic routes have their own category.

6.4.1 Routing Table Checking Flow

When the ZyWALL receives packets it defragments them and applies destination NAT. Then it examines the packets and determines how to route them. The checking flow is from top to bottom. As soon as the packets match an entry in one

of the sections, the ZyWALL stops checking the packets against the routing table and moves on to the other checks, for example the firewall check.

Figure 52 Routing Table Checking Flow

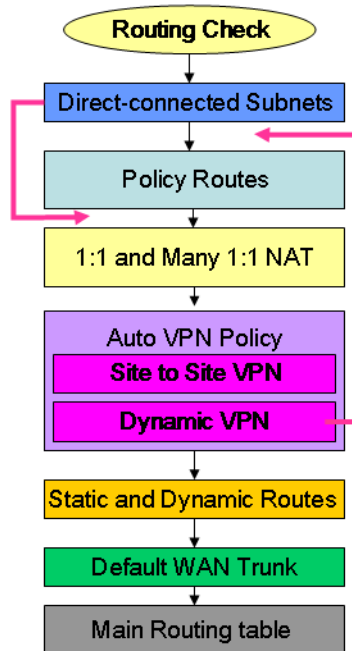

- 1 **Direct-connected Subnets:** The ZyWALL first checks to see if the packets are destined for an address in the same subnet as one of the ZyWALL's interfaces. You can override this and have the ZyWALL check the policy routes first by enabling the policy route feature's **Use Policy Route to Override Direct Route** option (see [Section 13.1 on page 297](#)).
- 2 **Policy Routes:** These are the user-configured policy routes. Configure policy routes to send packets through the appropriate interface or VPN tunnel. See [Chapter 13 on page 297](#) for more on policy routes.
- 3 **1 to 1 and Many 1 to 1 NAT:** These are the 1 to 1 NAT and many 1 to 1 NAT rules. If a private network server will initiate sessions to the outside clients, create a 1 to 1 NAT entry to have the ZyWALL translate the source IP address of the server's outgoing traffic to the same public IP address that the outside clients use to access the server. A many 1 to 1 NAT entry works like multiple 1 to 1 NAT rules. It maps a range of private network servers that will initiate sessions to the outside clients to a range of public IP addresses. See [Section 17.2.1 on page 340](#) for more.

- 4 **Auto VPN Policy:** The ZyWALL automatically creates these routing entries for the VPN rules. Disabling the IPsec VPN feature's **Use Policy Route to control dynamic IPsec rules** option moves the routes for dynamic IPsec rules up above the policy routes (see [Section 23.2 on page 394](#)).
- 5 **Static and Dynamic Routes:** This section contains the user-configured static routes and the dynamic routing information learned from other routers through RIP and OSPF. See [Chapter 13 on page 297](#) for more information.
- 6 **Default WAN Trunk:** For any traffic coming in through an internal interface, if it does not match any of the other routing entries, the ZyWALL forwards it through the default WAN trunk. See [Section 12.2 on page 292](#) for how to select which trunk the ZyWALL uses as the default.
- 7 **Main Routing Table:** The default WAN trunk is expected to be used for any traffic that did not match any earlier routing entries.

6.4.2 NAT Table Checking Flow

The checking flow is from top to bottom. As soon as the packets match an entry in one of the sections, the ZyWALL stops checking the packets against the NAT table and moves on to bandwidth management.

Figure 53 NAT Table Checking Flow

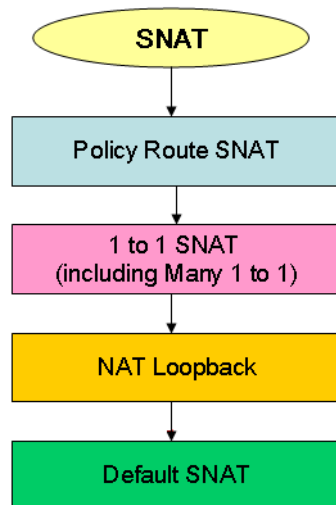

- 1 SNAT defined in the policy routes.
- 2 1 to 1 SNAT (including Many 1 to 1) is also included in the NAT table.
- 3 NAT loopback is now included in the NAT table instead of requiring a separate policy route.

- 4 SNAT is also now performed by default and included in the NAT table.

6.5 Feature Configuration Overview

This section provides information about configuring the main features in the ZyWALL. The features are listed in the same sequence as the menu item(s) in the Web Configurator. Each feature description is organized as shown below.

6.5.1 Feature

This provides a brief description. See the appropriate chapter(s) in this User's Guide for more information about any feature.

MENU ITEM(S)	This shows you the sequence of menu items and tabs you should click to find the main screen(s) for this feature. See the web help or the related User's Guide chapter for information about each screen.
PREREQUISITES	<p>These are other features you should configure before you configure the main screen(s) for this feature.</p> <p>If you did not configure one of the prerequisites first, you can often select an option to create a new object. After you create the object you return to the main screen to finish configuring the feature.</p> <p>You may not have to configure everything in the list of prerequisites. For example, you do not have to create a schedule for a policy route unless time is one of the criterion.</p>
WHERE USED	<p>There are two uses for this.</p> <p>These are other features you should usually configure or check right after you configure the main screen(s) for this feature. For example, you should usually create a policy route for a VPN tunnel.</p> <p>You have to delete the references to this feature before you can delete any settings. For example, you have to delete (or modify) all the policy routes that refer to a VPN tunnel before you can delete the VPN tunnel.</p>

Example: This provides a simple example to show you how to configure this feature. The example is usually based on the network topology in [Figure 50 on page 90](#).

Note: **PREREQUISITES** or **WHERE USED** does not appear if there are no prerequisites or references in other features to this one. For example, no other features reference DDNS entries, so there is no **WHERE USED** entry.

6.5.2 Licensing Registration

Use these screens to register your ZyWALL and subscribe to services like more SSL VPN tunnels, and content filtering. You must have Internet access to myZyXEL.com.

MENU ITEM(S)	Configuration > Licensing > Registration
PREREQUISITES	Internet access to myZyXEL.com

6.5.3 Interface

See [Section 6.2 on page 88](#) for background information.

Note: When you create an interface, there is no security applied on it until you assign it to a zone.

Most of the features that use interfaces support Ethernet, PPPoE/PPTP, cellular, VLAN, and bridge interfaces.

MENU ITEM(S)	Configuration > Network > Interface (except Network > Interface > Trunk)
PREREQUISITES	Port groups (configured in the Interface > Port Grouping screen)
WHERE USED	Zones, trunks, IPSec VPN, DDNS, policy routes, static routes, HTTP redirect, NAT

Example: The **dmz** interface is in the DMZ zone and uses a private IP address. To configure **dmz**'s settings, click **Network > Interface > Ethernet** and then the **dmz**'s **Edit** icon.

6.5.4 Trunks

Use trunks to set up load balancing using two or more interfaces.

MENU ITEM(S)	Configuration > Network > Interface > Trunk
PREREQUISITES	Interfaces
WHERE USED	Policy routes

Example: See [Chapter 7 on page 107](#).

6.5.5 Policy Routes

Use policy routes to override the ZyWALL's default routing behavior in order to send packets through the appropriate interface or VPN tunnel. You can also use policy routes for bandwidth management (out of the ZyWALL), port triggering,

and general NAT on the source address. You have to set up the criteria, next-hops, and NAT settings first.

MENU ITEM(S)	Configuration > Network > Routing > Policy Route
PREREQUISITES	<p>Criteria: users, user groups, interfaces (incoming), IPSec VPN (incoming), addresses (source, destination), address groups (source, destination), schedules, services, service groups</p> <p>Next-hop: addresses (HOST gateway), IPSec VPN, SSL VPN, trunks, interfaces</p> <p>NAT: addresses (translated address), services and service groups (port triggering)</p>

Example: You have an FTP server connected to **P6** (in the DMZ zone). You want to limit the amount of FTP traffic that goes out from the FTP server through your WAN connection.

- 1 Create an address object for the FTP server (**Object > Address**).
- 2 Click **Configuration > Network > Routing > Policy Route** to go to the policy route configuration screen. Add a policy route.
- 3 Name the policy route.
- 4 Select the interface that the traffic comes in through (**P3** in this example).
- 5 Select the FTP server's address as the source address.
- 6 You don't need to specify the destination address or the schedule.
- 7 For the service, select **FTP**.
- 8 For the **Next Hop** fields, select **Interface** as the **Type** if you have a single WAN connection or **Trunk** if you have multiple WAN connections.
- 9 Select the interface that you are using for your WAN connection. If you have multiple WAN connections, select the trunk.
- 10 Specify the amount of bandwidth FTP traffic can use. You may also want to set a low priority for FTP traffic.

Note: The ZyWALL checks the policy routes in the order that they are listed. So make sure that your custom policy route comes before any other routes that would also match the FTP traffic.

6.5.6 Static Routes

Use static routes to tell the ZyWALL about networks not directly connected to the ZyWALL.

MENU ITEM(S)	Configuration > Network > Routing > Static Route
PREREQUISITES	Interfaces

6.5.7 Zones

See [Section 6.2 on page 88](#) for background information. A zone is a group of interfaces and VPN tunnels. The ZyWALL uses zones, not interfaces, in many security settings, such as firewall rules and remote management.

Zones cannot overlap. Each interface and VPN tunnel can be assigned to at most one zone. Virtual interfaces are automatically assigned to the same zone as the interface on which they run. When you create a zone, the ZyWALL does not create any firewall rules, or configure remote management for the new zone.

MENU ITEM(S)	Configuration > Network > Zone
PREREQUISITES	Interfaces, IPSec VPN, SSL VPN
WHERE USED	Firewall, remote management, ADP

Example: For example, to create the DMZ-2 zone, click **Network > Zone** and then the **Add** icon.

6.5.8 DDNS

Dynamic DNS maps a domain name to a dynamic IP address. The ZyWALL helps maintain this mapping.

MENU ITEM(S)	Configuration > Network > DDNS
PREREQUISITES	Interface

6.5.9 NAT

Use Network Address Translation (NAT) to make computers on a private network behind the ZyWALL available outside the private network.

The ZyWALL only checks regular (through-ZyWALL) firewall rules for packets that are redirected by NAT, it does not check the to-ZyWALL firewall rules.

MENU ITEM(S)	Configuration > Network > NAT
---------------------	--

PREREQUISITES	Interfaces, addresses (HOST)
----------------------	------------------------------

Example: Suppose you have an FTP server with a private IP address connected to a DMZ port. You could configure a NAT rule to forwards FTP sessions from the WAN to the DMZ.

- 1 Click **Configuration > Network > NAT** to configure the NAT entry. Add an entry.
- 2 Name the entry.
- 3 Select the WAN interface that the FTP traffic is to come in through.
- 4 Specify the public WAN IP address where the ZyWALL will receive the FTP packets.
- 5 In the **Mapped IP field**, list the IP address of the FTP server. The ZyWALL will forward the packets received for the original IP address.
- 6 In **Mapping Type**, select **Port**.
- 7 Enter 21 in both the **Original** and the **Mapped Port** fields.

6.5.10 HTTP Redirect

Configure this feature to have the ZyWALL transparently forward HTTP (web) traffic to a proxy server. This can speed up web browsing because the proxy server keeps copies of the web pages that have been accessed so they are readily available the next time one of your users needs to access that page.

The ZyWALL does not check to-ZyWALL firewall rules for packets that are redirected by HTTP redirect. It does check regular (through-ZyWALL) firewall rules.

MENU ITEM(S)	Configuration > Network > HTTP Redirect
PREREQUISITES	Interfaces

Example: Suppose you want HTTP requests from your LAN to go to a HTTP proxy server at IP address 192.168.3.80.

- 1 Click **Configuration > Network > HTTP Redirect**.
- 2 Add an entry.
- 3 Name the entry.
- 4 Select the interface from which you want to redirect incoming HTTP requests (**lan1**).

- 5 Specify the IP address of the HTTP proxy server.
- 6 Specify the port number to use for the HTTP traffic that you forward to the proxy server.

6.5.11 ALG

The ZyWALL's Application Layer Gateway (ALG) allows VoIP and FTP applications to go through NAT on the ZyWALL. You can also specify additional signaling port numbers.

MENU ITEM(S)	Configuration > Network > ALG
---------------------	--

6.5.12 Auth. Policy

Use authentication policies to control who can access the network. You can authenticate users (require them to log in) and even perform Endpoint Security (EPS) checking to make sure users' computers comply with defined corporate policies before they can access the network.

MENU ITEM(S)	Configuration > Auth. Policy
PREREQUISITES	Addresses, services, endpoint security objects, users, authentication methods

6.5.13 Firewall

The firewall controls the travel of traffic between or within zones. You can also configure the firewall to control traffic for NAT (DNAT) and policy routes (SNAT). You can configure firewall rules based on schedules, specific users (or user groups), source or destination addresses (or address groups) and services (or service groups). Each of these objects must be configured in a different screen.

To-ZyWALL firewall rules control access to the ZyWALL. Configure to-ZyWALL firewall rules for remote management. By default, the firewall only allows management connections from the LAN or WAN zone.

MENU ITEM(S)	Configuration > Firewall
PREREQUISITES	Zones, schedules, users, user groups, addresses (source, destination), address groups (source, destination), services, service groups

Example: Suppose you have a SIP proxy server connected to the DMZ zone for VoIP calls. You could configure a firewall rule to allow VoIP sessions from the SIP proxy server on DMZ to the LAN so VoIP users on the LAN can receive calls.

- 1 Create a VoIP service object for UDP port 5060 traffic (**Configuration > Object > Service**).
- 2 Create an address object for the VoIP server (**Configuration > Object > Address**).
- 3 Click **Configuration > Firewall** to go to the firewall configuration.
- 4 Select from the **DMZ** zone to the **LAN1** zone, and add a firewall rule using the items you have configured.
 - You don't need to specify the schedule or the user.
 - In the **Source** field, select the address object of the VoIP server.
 - You don't need to specify the destination address.
 - Leave the **Access** field set to **Allow** and the **Log** field set to **No**.

Note: The ZyWALL checks the firewall rules in order. Make sure each rule is in the correct place in the sequence.

6.5.14 IPSec VPN

Use IPSec VPN to provide secure communication between two sites over the Internet or any insecure network that uses TCP/IP for communication. The ZyWALL also offers hub-and-spoke VPN.

MENU ITEM(S)	Configuration > VPN > IPSec VPN ; you can also use the Quick Setup VPN Setup wizard.
PREREQUISITES	Interfaces, certificates (authentication), authentication methods (extended authentication), addresses (local network, remote network, NAT), to-ZyWALL firewall, firewall
WHERE USED	Policy routes, zones

Example: See [Chapter 7 on page 107](#).

6.5.15 SSL VPN

Use SSL VPN to give remote users secure network access.

MENU ITEM(S)	Configuration > VPN > SSL VPN
PREREQUISITES	Interfaces, SSL application, users, user groups, addresses (network list, IP pool for assigning to clients, DNS and WINS server addresses), to-ZyWALL firewall, firewall
WHERE USED	Policy routes, zones

Example: See [Chapter 7 on page 107](#).

6.5.16 Bandwidth Management

Use bandwidth management (BWM) to configure a BWM rule for a specific IP address, destination port or IP range and specify allowed amounts of bandwidth and priorities.

MENU ITEM(S)	Configuration > BWM
PREREQUISITES	Zones

Examples: Suppose you want to give a user named Bob FTP access but with a limited download speed of 200 kbps from LAN (FTP client) to WAN (FTP server).

- 1 Create user account for Bob.
- 2 Click **BWM > Add New Policy**. Select the user account that you created for Bob.
- 3 Select from LAN zone to WAN zone (default).
- 4 Set BWM inbound value to 200kbps and keep the default values for all other fields.

6.5.17 ADP

Use ADP to detect and take action on traffic and protocol anomalies.

MENU ITEM(S)	Configuration > Anti-X > ADP
PREREQUISITES	Zones

6.5.18 Content Filter

Use content filtering to block or allow access to specific categories of web site content, individual web sites and web features (such as cookies). You can define which user accounts (or groups) can access what content and at what times. You must have a subscription in order to use the category-based content filtering. You can subscribe using the menu item or one of the wizards.

MENU ITEM(S)	Configuration > Anti-X > Content Filter
PREREQUISITES	Registration, addresses (source), schedules, users, user groups

Example: You can configure a policy that blocks Bill's access to arts and entertainment web pages during the workday. You must have already subscribed to the content filter service.

- 1 Create a user account for Bill if you have not done so already (**Configuration > Object > User/Group**).

- 2 Create a schedule for the work day (**Configuration > Object > Schedule**).
- 3 Click **Configuration > Anti-X > Content Filter > Filter Profile**. Click the **Add** icon to go to the screen where you can configure a category-based profile.
- 4 Name the profile and enable it.
- 5 Enable the external web filter service.
- 6 Decide what to do for matched web sites (**Block** in this example), unrated web sites and what to do when the category-based content filtering service is not available.
- 7 Select the **Arts/Entertainment** category (you need to click **Advanced** to display it) and click **OK**.
- 8 Click **General** to go to the content filter general configuration screen.
- 9 Enable the content filter.
- 10 Add a policy that uses the schedule, the filtering profile and the user that you created.

6.5.19 Anti-Spam

Use anti-spam to detect and take action on spam mail.

MENU ITEM(S)	Configuration > Anti-X > Anti-Spam
PREREQUISITES	Zones

6.6 Objects

Objects store information and are referenced by other features. If you update this information in response to changes, the ZyWALL automatically propagates the change through the features that use the object. Move your cursor over a configuration object that has a magnifying-glass icon (such as a user group, address, address group, service, service group, zone, or schedule) to display basic information about the object.

The following table introduces the objects. You can also use this table when you want to delete an object because you have to delete references to the object first.

Table 16 Objects Overview

OBJECT	WHERE USED
user/group	See the User/Group section on page 104 for details on users and user groups.
address	VPN connections (local / remote network, NAT), policy routes (criteria, next-hop [HOST], NAT), authentication policies, firewall, content filter, NAT (HOST), user settings (force user authentication), address groups, remote management (System)
address group	Policy routes (criteria), firewall, content filter, user settings (force user authentication), address groups, remote management (System)
service, service group	Policy routes (criteria, port triggering), firewall, service groups, log (criteria)
schedule	Policy routes (criteria), authentication policies, firewall, content filter, user settings (force user authentication)
AAA server	Authentication methods
authentication methods	VPN gateways (extended authentication), WWW (client authentication)
certificates	VPN gateways, WWW, SSH, FTP
SSL Application	SSL VPN
Endpoint Security	Authentication policies, SSL VPN

6.6.1 User/Group

Use these screens to configure the ZyWALL's administrator and user accounts. The ZyWALL provides the following user types.

Table 17 User Types

TYPE	ABILITIES
admin	Change ZyWALL configuration (web, CLI)
limited-admin	Look at ZyWALL configuration (web)
user	Access network services, browse user-mode commands (CLI)
guest	Access network services
ext-user	The same as a user or a guest except the ZyWALL looks for the specific type in an external authentication server. If the type is not available, the ZyWALL applies default settings.
ext-group-user	External group user account.

If you want to force users to log in to the ZyWALL before the ZyWALL routes traffic for them, you might have to configure prerequisites first.

MENU ITEM(S)	Object > User/Group
PREREQUISITES	Addresses, address groups, schedules. The prerequisites are only used in policies to force user authentication

WHERE USED	Policy routes, firewall, content filter, user groups, VPN
-------------------	---

6.7 System

This section introduces some of the management features in the ZyWALL. Use **Host Name** to configure the system and domain name for the ZyWALL. Use **Date/Time** to configure the current date, time, and time zone in the ZyWALL. Use **Console Speed** to set the console speed. Use **Language** to select a language for the Web Configurator screens.

6.7.1 DNS, WWW, SSH, TELNET, FTP, SNMP, Vantage CNM

Use these screens to set which services or protocols can be used to access the ZyWALL through which zone and from which addresses (address objects) the access can come.

MENU ITEM(S)	Configuration > System > DNS, WWW, SSH, TELNET, FTP, SNMP, Vantage CNM, Language
PREREQUISITES	To-ZyWALL firewall, zones, addresses, address groups, certificates (WWW, SSH, FTP, Vantage CNM), authentication methods (WWW)

Example: Suppose you want to allow an administrator to use HTTPS to manage the ZyWALL from the WAN.

- 1 Create an administrator account (**Configuration > Object > User/Group**).
- 2 Create an address object for the administrator's computer (**Configuration > Object > Address**).
- 3 Click **Configuration > System > WWW** to configure the HTTP management access. Enable HTTPS and add an administrator service control entry.
 - Select the address object for the administrator's computer.
 - Select the **WAN** zone.
 - Set the action to **Accept**.

6.7.2 Logs and Reports

The ZyWALL provides a system log, offers two e-mail profiles to which to send log messages, and sends information to four syslog servers. It can also e-mail you statistical reports on a daily basis.

MENU ITEM(S)	Configuration > Log & Report
---------------------	--

6.7.3 File Manager

Use these screens to upload, download, delete, or run scripts of CLI commands. You can manage

- Configuration files. Use configuration files to back up and restore the complete configuration of the ZyWALL. You can store multiple configuration files in the ZyWALL and switch between them without restarting.
- Shell scripts. Use shell scripts to run a series of CLI commands. These are useful for large, repetitive configuration changes (for example, creating a lot of VPN tunnels) and for troubleshooting.

You can edit configuration files and shell scripts in any text editor.

MENU ITEM(S)	Maintenance > File Manager
---------------------	----------------------------

6.7.4 Diagnostics

The ZyWALL can generate a file containing the ZyWALL's configuration and diagnostic information. It can also capture packets going through the ZyWALL's interfaces so you can analyze them to identify network problems.

MENU ITEM(S)	Maintenance > Diagnostics
---------------------	---------------------------

6.7.5 Shutdown

Use this to shutdown the device in preparation for disconnecting the power.

Always use **Maintenance > Shutdown > Shutdown** or the `shutdown` command before you turn off the ZyWALL or remove the power. Not doing so can cause the firmware to become corrupt.

MENU ITEM(S)	Maintenance > Shutdown
---------------------	------------------------

Tutorials

Here are examples of using the Web Configurator to set up features in the ZyWALL.

Note: The tutorials featured here require a basic understanding of connecting to and using the Web Configurator, see [Chapter 3 on page 43](#) for details. For field descriptions of individual screens, see [Technical Reference on page 163](#).

7.1 How to Configure Interfaces, Port Roles, and Zones

This tutorial shows how to configure Ethernet interfaces, port roles, and zones for the following example configuration (see [Section 6.2.2 on page 90](#) for the default configuration).

- You want to be able to apply security settings specifically for all VPN tunnels so you create a new VPN zone.
- The **wan1** interface uses a static IP address of 1.2.3.4.

- Convert **P5** (lan2) into a **dmz** interface. This **dmz** interface is used for a protected local network. It uses IP address 192.168.4.1 and has a DHCP server. Add it to the LAN zone so all of the LAN zone's security policies apply to it.

Figure 54 Ethernet Interface, Port Roles, and Zone Configuration Example

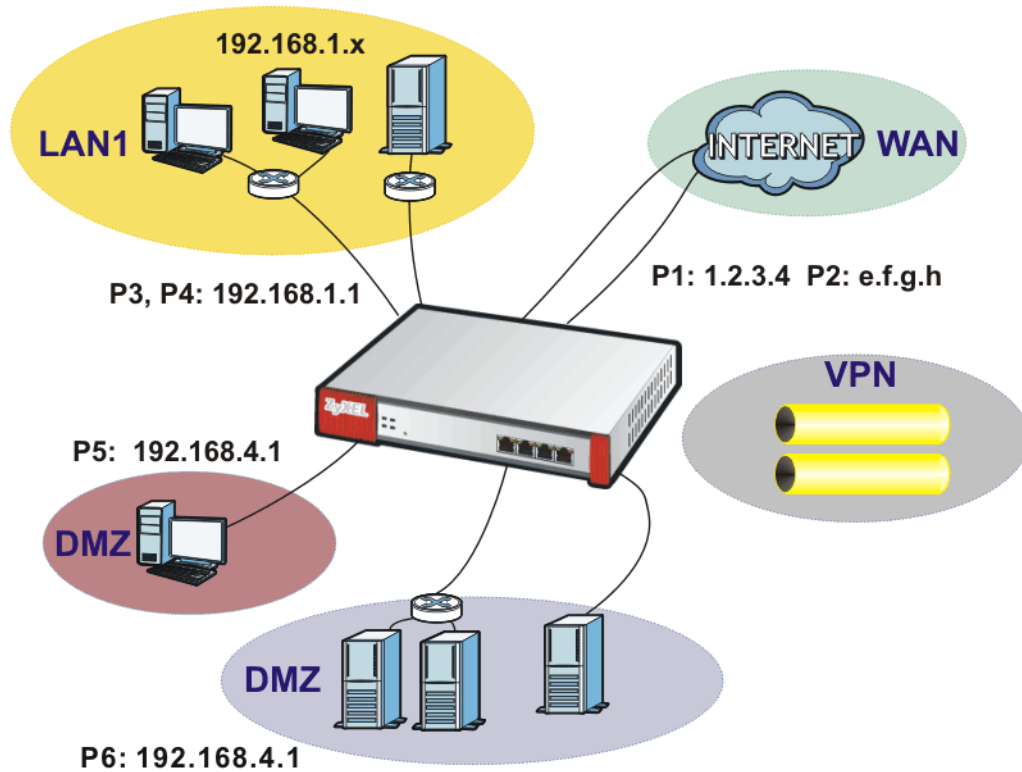

7.1.1 Configure a WAN Ethernet Interface

You need to assign the ZyWALL's **wan1** interface a static IP address of 1.2.3.4.

Click **Configuration > Network > Interface > Ethernet** and double-click the **wan1** interface's entry. Select **Use Fixed IP Address** and configure the IP address, subnet mask, and default gateway settings and click **OK**.

Figure 55 Configuration > Network > Interface > Ethernet > Edit wan1

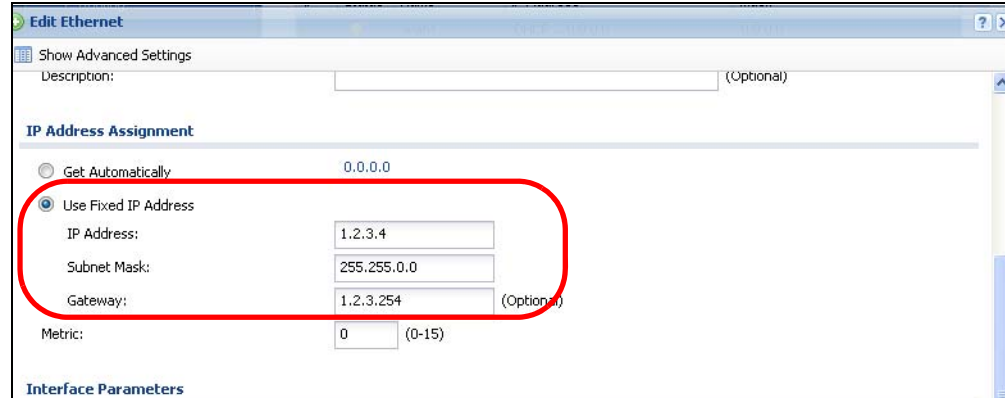

7.1.2 Configure Port Roles

Here is how to convert port **P5** from the lan2 interface and add it to the dmz interface.

- 1 Click **Configuration > Network > Interface > Role**.
- 2 Under **P5** select the **dmz (DMZ)** radio button and click **Apply**.

Figure 56 Configuration > Network > Interface > Port Roles Example

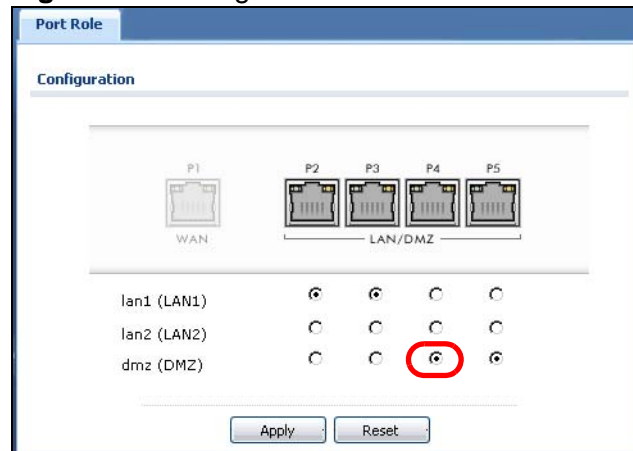

7.1.3 Configure the DMZ Interface for a Local Network

Here is how to set the **dmz** interface (created in the previous section) for a separate local network. It uses 192.168.4.1 as its IP address and has a DHCP server to distribute IP addresses to connected DHCP clients.

- 1 Click **Configuration > Network > Interface > Ethernet** and double-click the **lan2** interface's entry.

The **Interface Type** should be **internal**.

Set the **IP Address** to 192.168.4.1 and the **Subnet Mask** to 255.255.255.0.

Set **DHCP** to **DHCP Server** and click **OK**.

Figure 57 Configuration > Network > Interface > Ethernet > Edit lan2

The screenshot shows the 'Edit Ethernet' configuration window for the 'lan2' interface. The window is titled 'Edit Ethernet' and has a 'Show Advanced Settings' button. The configuration is organized into several sections:

- General Settings:** Includes a checked 'Enable Interface' option.
- Interface Properties:** Shows 'Interface Type' set to 'internal', 'Interface Name' as 'lan2', 'Port' as 'none', 'Zone' as 'LAN2', and 'MAC Address' as '00:00:AA:79:08:53'. There is an optional 'Description' field.
- IP Address Assignment:** Shows 'IP Address' set to '192.168.4.1' and 'Subnet Mask' set to '255.255.255.0'.
- Interface Parameters:** Shows 'Egress Bandwidth' set to '1048576' Kbps.
- DHCP Setting:** Shows 'DHCP' set to 'DHCP Server', 'IP Pool Start Address (Optional)' as an empty field, 'Pool Size' as '200', 'First DNS Server (Optional)' as 'ZyWALL', 'Second DNS server (Optional)' as 'Custom Defined', 'Third DNS Server (Optional)' as 'Custom Defined', 'First WINS Server (Optional)' as an empty field, 'Second WINS Server (Optional)' as an empty field, and 'Lease time' set to '2 days 0 hours (Optional) 0 minutes (Optional)'.

At the bottom right, there are 'OK' and 'Cancel' buttons.

7.1.4 Configure Zones

Do the following to create a VPN zone.

- 1 Click **Configuration > Network > Zone** and then the **Add** icon.

- 2 Enter **VPN** as the name, select **WIZ_VPN_Connection** and move it to the **Member** box and click **OK**.

Figure 58 Configuration > Network > Zone > WAN Edit

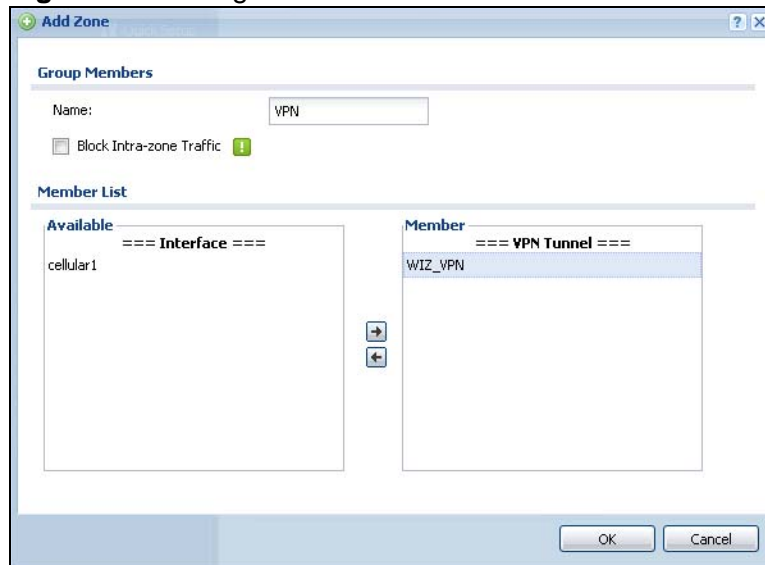

7.2 How to Configure a Cellular Interface

Use 3G cards for cellular WAN (Internet) connections. [Table 229 on page 741](#) lists the compatible 3G devices. In this example you connect the 3G USB card before you configure the cellular interfaces but is also possible to reverse the sequence.

- 1 Make sure the 3G device's SIM card is installed.
- 2 Connect the 3G device to one of the ZyWALL's USB ports.
- 3 Click **Configuration > Network > Interface > Cellular**. Select the 3G device's entry and click **Edit**.

Figure 59 Configuration > Network > Interface > Cellular

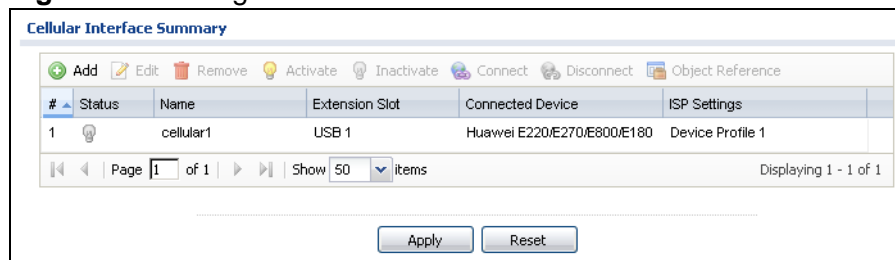

- 4 Enable the interface and add it to a zone. It is highly recommended that you set the **Zone** to **WAN** to apply your WAN zone security settings to this 3G connection. Leaving **Zone** set to **none** has the ZyWALL not apply any security settings to the 3G connection. Enter the **PIN Code** provided by the cellular 3G service provider (0000 in this example).

Figure 60 Configuration > Network > Interface > Cellular > Edit

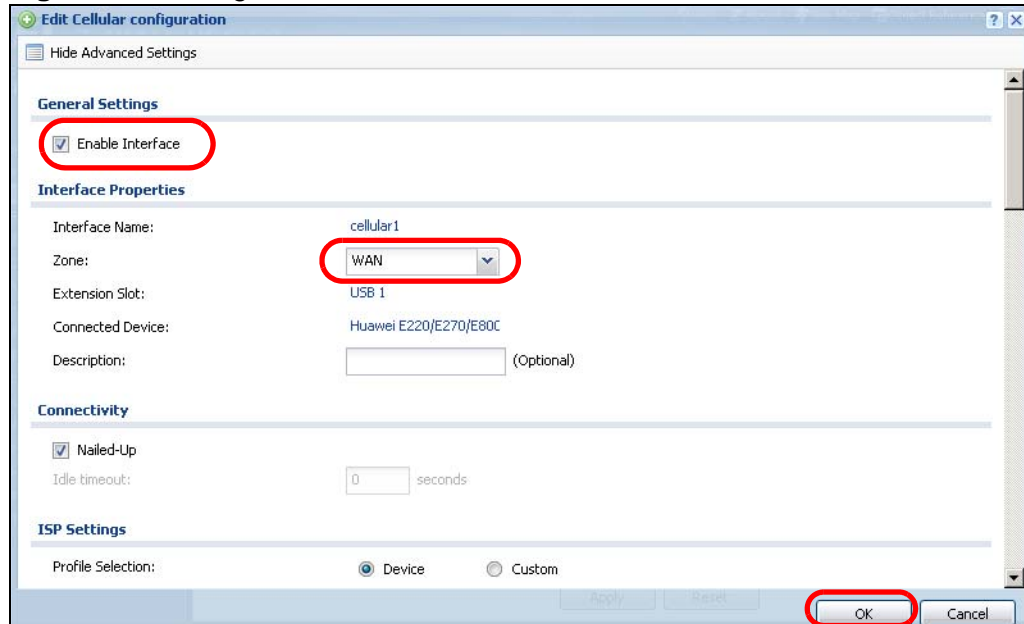

Note: The **Network Selection** is set to **Auto** by default. This means that the 3G USB modem may connect to another 3G network when your service provider is not in range or when necessary. Select **Home** to have the 3G device connect only to your home network or local service provider. This prevents you from being charged using the rate of a different ISP.

- 5 Go to the **Dashboard**. The **Interface Status Summary** section should contain a "cellular" entry. When its connection status is **Connected** you can use the 3G connection to access the Internet.

Figure 61 Status

#	Name	Status	Zone	IP Address	Action
1	wan1	Down	WAN	0.0.0.0	n/a
2	wan1_pp	Disconnected	WAN		
3	wan2	Down	WAN	0.0.0.0	Renew
4	lan1	Down	LAN1	192.168.1.1	n/a
5	lan2	100M/Full	LAN2	192.168.2.1	n/a
6	dmz	Down	DMZ	192.168.3.1	n/a
7	cellular1	Connected	n/a		

- 6 The ZyWALL automatically adds the cellular interface to the system default WAN trunk. If the ZyWALL is using a user-configured trunk as its default trunk and you want this cellular interface to be part of it, use the **Trunk** screens to add it.

This way the ZyWALL can automatically balance the traffic load amongst the available WAN connections to enhance overall network throughput. Plus, if a WAN connection goes down, the ZyWALL still sends traffic through the remaining WAN connections. For a simple test, disconnect all of the ZyWALL's wired WAN connections. If you can still access the Internet, your cellular interface is properly configured and your cellular device is working.

To fine-tune the load balancing configuration, see [Chapter 12 on page 289](#). See also [Section 7.3 on page 113](#) for an example.

7.3 How to Configure Load Balancing

This example shows how to configure a trunk for two WAN connections (to the Internet). The available bandwidth for the connections is 1Mbps (**wan1**) and 512 Kbps (**cellular1**) respectively. As these connections have different bandwidth, use the **Weighted Round Robin** algorithm to send traffic to wan1 and cellular1 in a 2:1 ratio.

Figure 62 Trunk Example

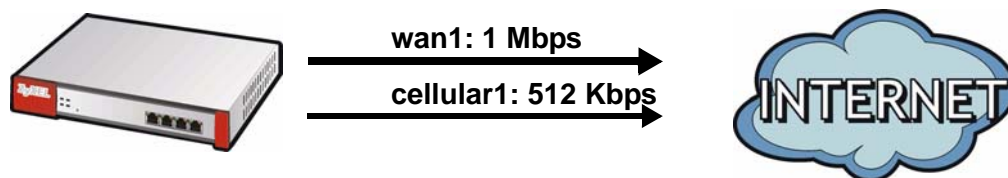

You do not have to change many of the ZyWALL's settings from the defaults to set up this trunk. You only have to set up the outgoing bandwidth on each of the WAN interfaces and configure the WAN_TRUNK trunk's load balancing settings.

7.3.1 Set Up Available Bandwidth on Ethernet Interfaces

Here is how to set a limit on how much traffic the ZyWALL tries to send out through each WAN interface.

- 1 Click **Configuration > Network > Interface > Ethernet** and double-click the **wan1** entry. Enter the available bandwidth (1000 kbps) in the **Egress Bandwidth** field. Click **OK**.

Figure 63 Configuration > Network > Interface > Ethernet > Edit (wan1)

The screenshot shows the 'Edit Ethernet' configuration window for the 'wan1' interface. The window is divided into several sections:

- General Settings:** Includes a checked 'Enable Interface' checkbox.
- Interface Properties:** Shows 'Interface Type' as 'external', 'Interface Name' as 'wan1', 'Port' as 'P1', 'Zone' as 'WAN', and 'MAC Address' as '00:13:49:00:00:01'. There is an optional 'Description' field.
- IP Address Assignment:** The 'Use Fixed IP Address' radio button is selected. Fields include 'IP Address' (1.2.3.4), 'Subnet Mask' (255.255.0.0), 'Gateway' (1.2.3.254), and 'Metric' (0).
- Interface Parameters:** The 'Egress Bandwidth' field is highlighted with a red circle and contains the value '1000' with a unit dropdown set to 'Kbps'.
- Connectivity Check:** Includes an unchecked 'Enable Connectivity Check' checkbox.

Buttons for 'OK' and 'Cancel' are located at the bottom right of the window.

- 2 Go to **Configuration > Network > Interface > Cellular**. Double-click the **cellular1** entry and set the egress bandwidth for **cellular1** to 512 Kbps.

7.3.2 Configure the WAN Trunk

- 1 Click **Configuration > Network > Interface > Trunk**. Click the **Add** icon.

- 2 Name the trunk and set the **Load Balancing Algorithm** field to **Weighted Round Robin**.

Add **wan1** and enter 2 in the **Weight** column.

Add **cellular1** and enter 1 in the **Weight** column.

Click **OK**.

Figure 64 Configuration > Network > Interface > Trunk > Add

The screenshot shows the 'Add Trunk' configuration window. The 'Name' field is set to 'example' and the 'Load Balancing Algorithm' is set to 'Weighted Round Robin'. Below these fields is a table with the following data:

#	Member	Mode	Weight
1	cellular1	Active	1
2	wan1	Active	2

The 'wan1' row is selected. The window also includes 'Add', 'Edit', 'Remove', and 'Move' buttons, and 'OK' and 'Cancel' buttons at the bottom.

- 3 Select the trunk as the default trunk and click **Apply**.

Figure 65 Configuration > Network > Interface > Trunk

Port Grouping Ethernet PPP Cellular WLAN VLAN Bridge Auxiliary **Trunk**

Show Advanced Settings

Configuration

Enable Link Sticking ⓘ

Timeout: (30-600 seconds) ⓘ

Default WAN Trunk

Default Trunk Selection

SYSTEM_DEFAULT_WAN_TRUNK

User Configured Trunk

User Configuration

#	Name	Algorithm
1	example	wrr

Page 1 of 1 Show 50 items Displaying 1 - 1 of 1

System Default

#	Name	Algorithm
1	SYSTEM_DEFAULT_WAN_TR Trunk	wrr

Page 1 of 1 Show 50 items Displaying 1 - 1 of 1

7.4 How to Set Up an IPSec VPN Tunnel

This example shows how to use the IPSec VPN configuration screens to create the following VPN tunnel, see [Section 5.4 on page 76](#) for details on the VPN quick setup wizard.

Figure 66 VPN Example

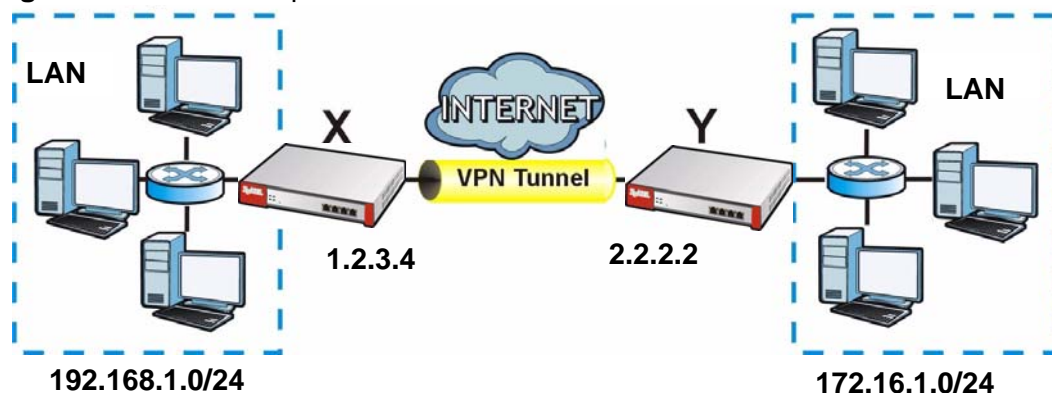

In this example, the ZyWALL is router **X** (1.2.3.4), and the remote IPSec router is router **Y** (2.2.2.2). Create the VPN tunnel between ZyWALL **X**'s LAN subnet (192.168.1.0/24) and the LAN subnet behind peer IPSec router **Y** (172.16.1.0/24).

7.4.1 Set Up the VPN Gateway

The VPN gateway manages the IKE SA. You do not have to set up any other objects before you configure the VPN gateway because this VPN tunnel does not use any certificates or extended authentication.

- 1 Click **Configuration > VPN > IPSec VPN > VPN Gateway**, and then click the **Add** icon.
- 2 Enable the VPN gateway and name it ("VPN_GW_EXAMPLE"). For **My Address**, select **Interface** and **wan1**. For the **Peer Gateway Address**, select **Static Address** and enter 2.2.2.2 in the **Primary** field. For the **Authentication**, Select **Pre-Shared Key** and enter 12345678. Click **OK**.

Figure 67 Configuration > VPN > IPSec VPN > VPN Gateway > Add

Add VPN Gateway

Show Advanced Settings

General Settings

Enable

VPN Gateway Name:

Gateway Settings

My Address

Interface Static -- 1.2.3.4/255.255.0.0

Domain Name / IP

Peer Gateway Address

Static Address

Primary

Secondary

Fall back to Primary Peer Gateway when possible

Fall Back Check Interval: (60-86400 seconds)

Dynamic Address

Authentication

Pre-Shared Key

Certificate (See My Certificates)

Phase 1 Settings

SA Life Time: (180 - 3000000 Seconds)

OK Cancel

7.4.2 Set Up the VPN Connection

The VPN connection manages the IPSec SA. You have to set up the address objects for the local network and remote network before you can set up the VPN connection.

- 1 Click **Configuration > Object > Address**. Click the **Add** icon.
- 2 Give the new address object a name ("VPN_REMOTE_SUBNET"), change the **Address Type** to **SUBNET**. Set up the **Network** field to 172.16.1.0 and the **Netmask** to 255.255.255.0. Click **OK**.

Figure 68 Configuration > Object > Address > Add

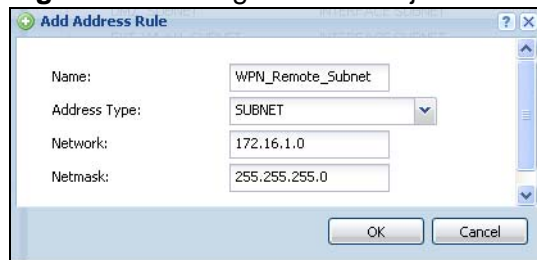

- 3 Click **Configuration > VPN > IPSec VPN > VPN Connection**. Click the **Add** icon.

- 4 Enable the VPN connection and name it ("VPN_CONN_EXAMPLE"). Under **VPN Gateway** select **Site-to-site** and the VPN gateway (**VPN_GW_EXAMPLE**). Under **Policy**, select **LAN1_SUBNET** for the local network and **VPN_REMOTE_SUBNET** for the remote. Click **OK**.

Figure 69 Configuration > VPN > IPSec VPN > VPN Connection > Add

- 5 Now set up the VPN settings on the peer IPSec router and try to establish the VPN tunnel. To trigger the VPN, either try to connect to a device on the peer IPSec router's LAN or click **Configuration > VPN > IPSec VPN > VPN Connection** and use the VPN connection screen's **Connect** icon.

7.4.3 Configure Security Policies for the VPN Tunnel

You configure security policies based on zones. The new VPN connection was assigned to the IPSec_VPN zone. By default, there are no security restrictions on the IPSec_VPN zone, so, next, you should set up security policies (firewall rules and so on) that apply to the IPSec_VPN zone. Make sure all firewalls between the ZyWALL and remote IPSec router allow UDP port 500 (IKE) and IP protocol 50 (AH) or 51 (ESP). If you enable NAT traversal, all firewalls between the ZyWALL and remote IPSec router should also allow UDP port 4500.

7.5 How to Configure User-aware Access Control

You can configure many policies and security settings for specific users or groups of users. This is illustrated in the following example, where you will set up the following policies. This is a simple example that does not include priorities for different types of traffic. See [Bandwidth Management on page 445](#) for more on bandwidth management.

Table 18 User-aware Access Control Example

GROUP (USER)	WEB SURFING	WEB BANDWIDTH	MSN	LAN1-TO-DMZ ACCESS
Finance (Leo)	Yes	200K	No	Yes
Engineer (Steven)	Yes	100K	No	No
Sales (Debbie)	Yes	100K	Yes (M-F, 08:30~18:00)	Yes
Boss (Andy)	Yes	100K	Yes	Yes
Guest (guest)	Yes	50K	No	No
Others	No	---	No	No

The users are authenticated by an external RADIUS server at 192.168.1.200.

First, set up the user accounts and user groups in the ZyWALL. Then, set up user authentication using the RADIUS server. Finally, set up the policies in the table above.

The ZyWALL has its default settings.

7.5.1 Set Up User Accounts

Set up one user account for each user account in the RADIUS server. If it is possible to export user names from the RADIUS server to a text file, then you might create a script to create the user accounts instead. This example uses the Web Configurator.

- 1 Click **Configuration > Object > User/Group > User**. Click the **Add** icon.

- 2 Enter the same user name that is used in the RADIUS server, and set the **User Type** to **ext-user** because this user account is authenticated by an external server. Click **OK**.

Figure 70 Configuration > Object > User/Group > User > Add

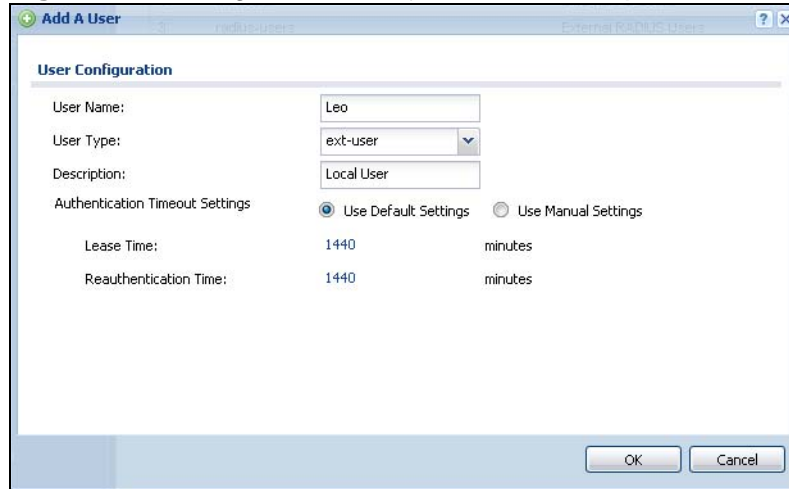

The screenshot shows a configuration window titled "Add A User" with the following fields and settings:

- User Name: Leo
- User Type: ext-user
- Description: Local User
- Authentication Timeout Settings: Use Default Settings, Use Manual Settings
- Lease Time: 1440 minutes
- Reauthentication Time: 1440 minutes

Buttons: OK, Cancel

- 3 Repeat this process to set up the remaining user accounts.

7.5.2 Set Up User Groups

Set up the user groups and assign the users to the user groups.

- 1 Click **Configuration > Object > User/Group > Group**. Click the **Add** icon.

- 2 Enter the name of the group that is used in the example in [Table 18 on page 120](#). In this example, it is "Finance". Then, select **User/Leo** and click the right arrow to move him to the **Member** list. This example only has one member in this group, so click **OK**. Of course you could add more members later.

Figure 71 Configuration > Object > User/Group > Group > Add

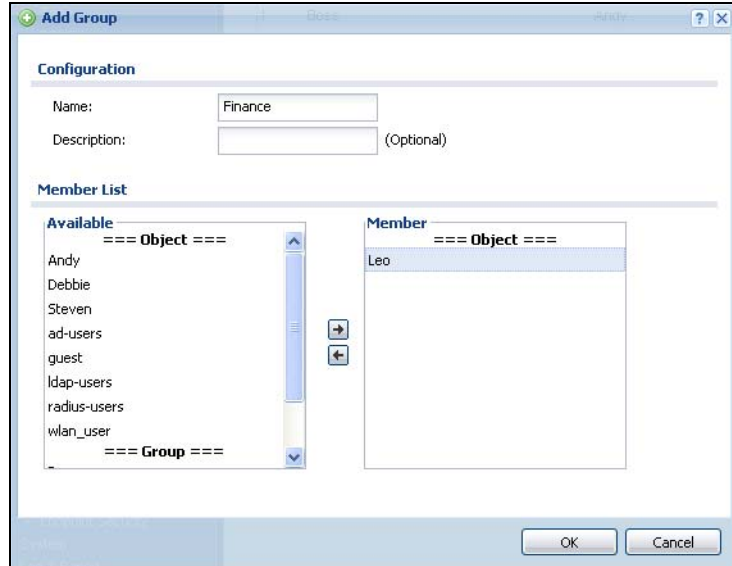

- 3 Repeat this process to set up the remaining user groups.

7.5.3 Set Up User Authentication Using the RADIUS Server

This step sets up user authentication using the RADIUS server. First, configure the settings for the RADIUS server. Then, set up the authentication method, and configure the ZyWALL to use the authentication method. Finally, force users to log in to the ZyWALL before it routes traffic for them.

- 1 Click **Configuration > Object > AAA Server > RADIUS**. Double-click the **radius** entry. Configure the RADIUS server's address authentication port (1812 if you were not told otherwise), key, and click **Apply**.

Figure 72 Configuration > Object > AAA Server > RADIUS > Add

- 2 Click **Configuration > Object > Auth. method**. Double-click the **default** entry. Click the **Add** icon. Select **group radius** because the ZyWALL should use the specified RADIUS server for authentication. Click **OK**.

Figure 73 Configuration > Object > Auth. method > Add

- 3 Click **Configuration > Auth. Policy**. In the **Authentication Policy Summary** section, click the **Add** icon.
- 4 Set up a default policy that forces every user to log in to the ZyWALL before the ZyWALL routes traffic for them. Select **Enable**. Set the **Authentication** field to **required**, and make sure **Force User Authentication** is selected. Keep the rest of the default settings, and click **OK**.

Note: The users will have to log in using the Web Configurator login screen before they can use HTTP or MSN.

Figure 74 Configuration > Object > User/Group > Setting > Add (Force User Authentication Policy)

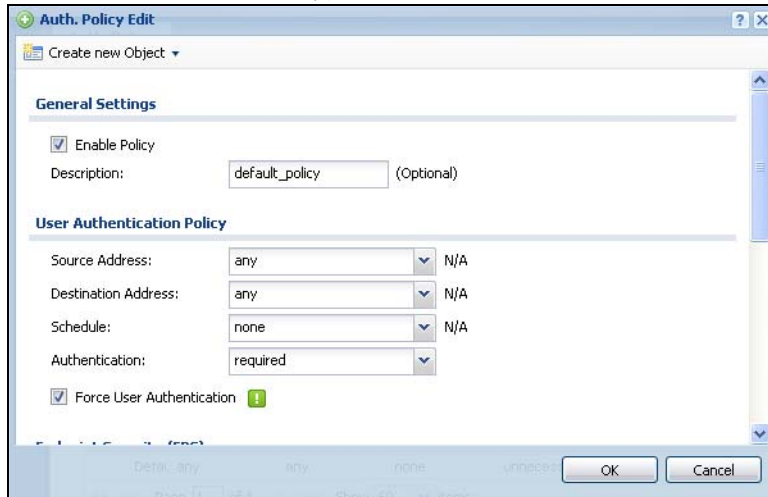

When the users try to browse the web (or use any HTTP/HTTPS application), the **Login** screen appears. They have to log in using the user name and password in the RADIUS server.

7.6 How to Use a RADIUS Server to Authenticate User Accounts based on Groups

The previous example showed how to have a RADIUS server authenticate individual user accounts. If the RADIUS server has different user groups distinguished by the value of a specific attribute, you can configure the make a couple of slight changes in the configuration to have the RADIUS server authenticate groups of user accounts defined in the RADIUS server.

- 1 Click **Configuration > Object > AAA Server > RADIUS**. Double-click the **radius** entry. Besides configuring the RADIUS server's address, authentication port, and key; set the **Group Membership Attribute** field to the attribute that the ZyWALL is to check to determine to which group a user belongs. This example uses **Class**. This attribute's value is called a group identifier; it determines to which group a user belongs. In this example the values are Finance, Engineer, Sales, and Boss.

Figure 75 Configuration > Object > AAA Server > RADIUS > Add

The screenshot shows the 'Edit RADIUS' configuration window with the following settings:

General Settings		
Name:	radius	
Description:	<input type="text"/>	Optional

Server Settings		
Server Address:	192.168.1.200	(IP or FQDN)
Authentication Port:	1812	(1-65535)
Backup Server Address:	<input type="text"/>	(IP or FQDN)Optional
Backup Authentication Port:	<input type="text"/>	(1-65535)Optional
Timeout:	5	(1-300 seconds)

Server Authentication		
Key:	<input type="password" value="....."/>	

User Login Settings		
Group Membership Attribute:	Class(25)	25

Buttons: OK, Cancel

- Now you add ext-group-user user objects to identify groups based on the group identifier values. Set up one user account for each group of user accounts in the RADIUS server. Click **Configuration > Object > User/Group > User**. Click the **Add** icon.

Enter a user name and set the **User Type** to **ext-group-user**. In the **Group Identifier** field, enter Finance, Engineer, Sales, or Boss and set the Associated AAA Server Object to radius.

Figure 76 Configuration > Object > User/Group > User > Add

- Repeat this process to set up the remaining groups of user accounts.

7.7 How to Use Endpoint Security and Authentication Policies

Here is how to use endpoint security to make sure that users' computers meet specific security requirements before they are allowed to access the network. This example requires users to have Kaspersky Internet security or anti-virus software on their computers before they can access the network.

7.7.1 Configure the Endpoint Security Objects

Click **Configuration > Object > Endpoint Security > Add** to open the **Endpoint Security Edit** screen.

- Select **Endpoint must comply with all checking items**.
- Set the **Endpoint Operating System** to **Windows** and the **Window Version** to **Windows 7**.

- Select **Endpoint must have Personal Firewall installed** and move the Kaspersky Internet Security entries to the allowed list (you can double-click an entry to move it).
- Select **Endpoint must have Anti-Virus software installed** and move the Kaspersky Internet Security and Kaspersky Anti-Virus anti-virus software entries to the allowed list.

The following figure shows the configuration screen example.

Figure 77 Configuration > Object > Endpoint Security > Add

The screenshot shows the 'Edit EPS' configuration window with the following sections:

- General Settings:** Object Name: Windows-7-Example; Description: (empty); Passing Criterion: Endpoint must comply with all checking items.
- Checking Item - Operating System:** Endpoint Operating System: Windows; Window Version: Windows 7; Endpoint must update to Windows Service Pack: (empty) (ex: 2 for at least SP2 update, blank for don't care).
- Checking Item - Windows Update and Security Patch:**
 - Windows Update Settings: Endpoint must enable Windows Auto Update.
 - Windows Security Patch that endpoint must have: A list with 'Add' and 'Remove' buttons. The list is currently empty, showing 'Page 1 of 1' and 'Show 50 items'. Below the list, it says 'Example: "Windows Security Patch": KB5682'.
- Checking Item - Personal Firewall:** Endpoint must have Personal Firewall installed.
 - Available:** F-Secure_Anti-Virus_Client_Security, F-Secure_Internet_Security_2007, McAfee_Anti-Virus_2007, McAfee_Internet_Security_2007, McAfee_Total_Protection_2007, Microsoft_Security_Center.
 - Allowed Personal Firewall List:** Kaspersky_Internet_Security_v6_0_2_614, Kaspersky_Internet_Security_v6_0_2_621, Kaspersky_Internet_Security_v7_0_0_119, Kaspersky_Internet_Security_v7_0_0_120, Kaspersky_Internet_Security_v8_0_0_506.
 - Endpoint needs to match any of the personal firewall.
- Checking Item - Anti-Virus Software:** Endpoint must have Anti-Virus software installed.
 - Available:** F-Secure_Anti-Virus_2007, F-Secure_Anti-Virus_Client_Security, F-Secure_Internet_Security_2007, McAfee_Anti-Virus_2007, McAfee_Internet_Security_2007, McAfee_Total_Protection_2007.
 - Allowed Anti-Virus Software List:** Kaspersky_Anti-Virus_v6_0_2_614, Kaspersky_Anti-Virus_v6_0_2_621, Kaspersky_Anti-Virus_v8_0_0_506, Kaspersky_Internet_Security_v6_0_2_614, Kaspersky_Internet_Security_v6_0_2_621, Kaspersky_Internet_Security_v7_0_0_119.
 - Endpoint needs to match any of the anti-virus.

Buttons: OK, Cancel

Repeat as needed to create endpoint security objects for other Windows operating system versions.

7.7.2 Configure the Authentication Policy

Click **Configuration > Auth. Policy > Add** to open the **Endpoint Security Edit** screen. Use this screen to configure an authentication policy to use endpoint security objects.

- Enable the policy and name it.
- Set the **Source Address** to LAN1 and the **Destination Address** to **any**, the **Schedule** set to **none**, and **Authentication** set to **required** to apply this policy to all users.
- Select **Force User Authentication** to redirect the HTTP traffic of users who are not yet logged in to the ZyWALL's login screen.
- Enable EPS checking and move the EPS objects you created to the selected list.
- Click **OK**.

Figure 78 Configuration > Auth. Policy > Add

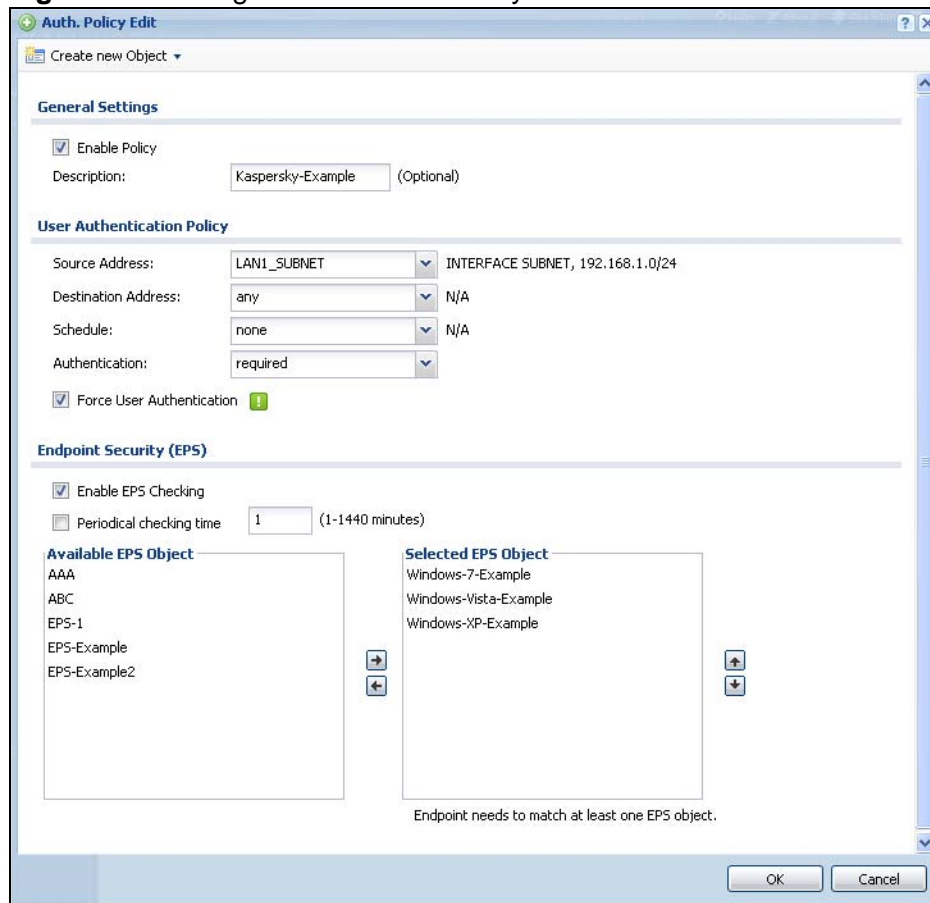

- 4 Turn on authentication policy and click **Apply**.

Figure 79 Configuration > Auth. Policy

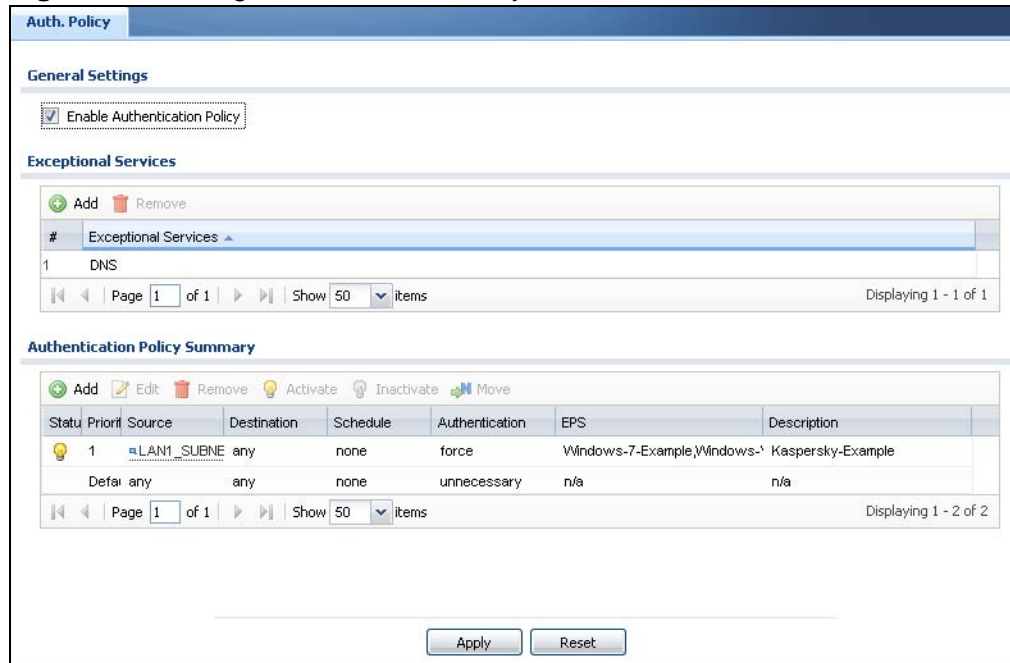

The following figure shows an error message example when a user's computer does not meet an endpoint security object's requirements. Click **Close** to return to the login screen.

Figure 80 Example: Endpoint Security Error Message

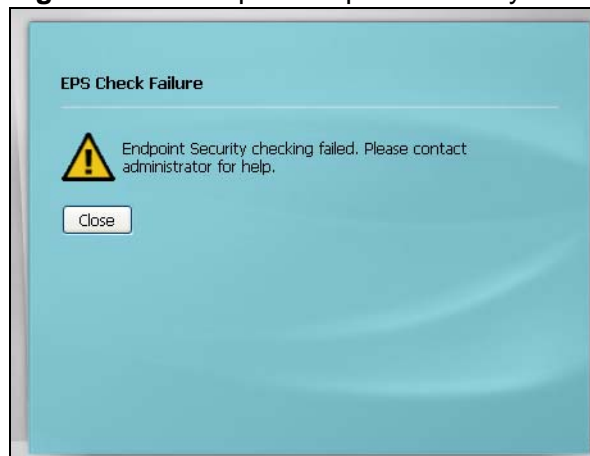

7.8 How to Configure Service Control

Service control lets you configure rules that control HTTP and HTTPS management access (to the Web Configurator) and separate rules that control HTTP and HTTPS

user access (logging into SSL VPN for example). See [Chapter 43 on page 629](#) for more on service control.

The To-ZyWALL firewall rules apply to any kind of HTTP or HTTPS connection to the ZyWALL. They do not distinguish between administrator management access and user access. If you configure service control to allow management or user HTTP or HTTPS access, make sure the firewall is not configured to block that access.

7.8.1 Allow HTTPS Administrator Access Only From the LAN

This example configures service control to block administrator HTTPS access from all zones except the LAN1.

- 1 Click **Configuration > System > WWW**.
- 2 In **HTTPS Admin Service Control**, click the **Add** icon.

Figure 81 Configuration > System > WWW



- 3 In the **Zone** field select **LAN1** and click **OK**.

Figure 82 Configuration > System > WWW > Service Control Rule Edit

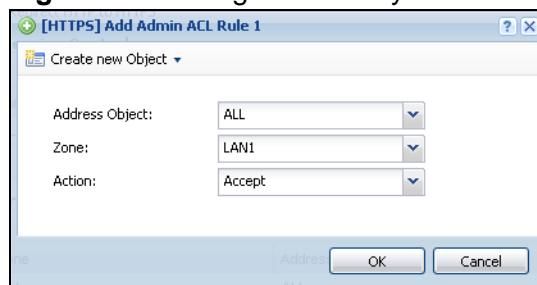

- Select the new rule and click the **Add** icon.

Figure 83 Configuration > System > WWW (First Example Admin Service Rule Configured)

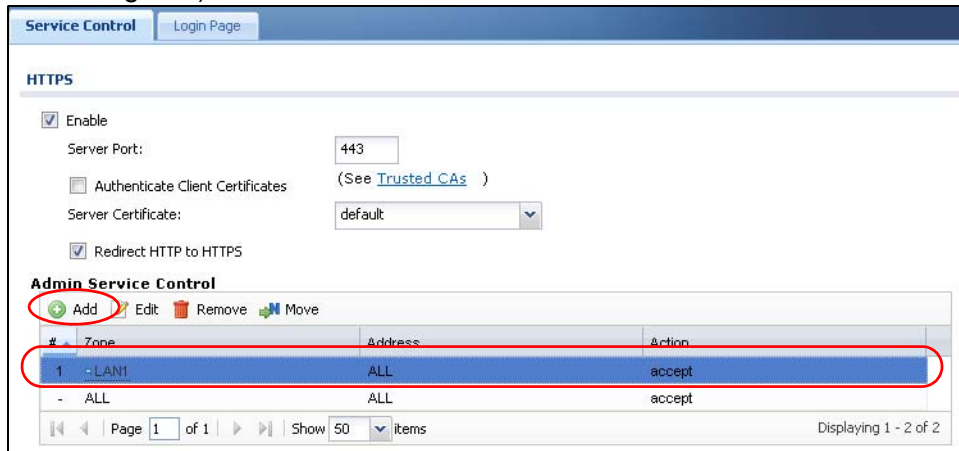

- In the **Zone** field select **ALL** and set the **Action** to **Deny**. Click **OK**.

Figure 84 Configuration > System > WWW > Service Control Rule Edit

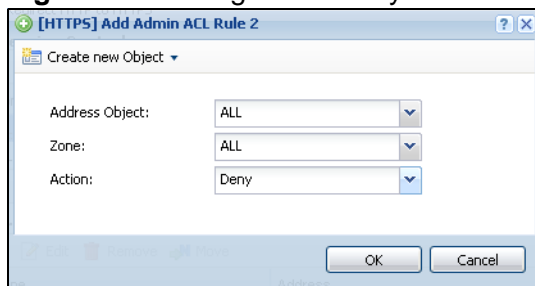

6 Click **Apply**.**Figure 85** Configuration > System > WWW (Second Example Admin Service Rule Configured)

The screenshot shows the 'Service Control' configuration page for the WWW service. It is divided into three main sections: HTTPS, Admin Service Control, and HTTP.

HTTPS Section:

- Enable
- Server Port: 443
- Authenticate Client Certificates (See [Trusted CAs](#))
- Server Certificate: default
- Redirect HTTP to HTTPS

Admin Service Control Section:

Buttons: Add, Edit, Remove, Move

#	Zone	Address	Action
1	LAN1	ALL	accept
2	ALL	ALL	deny
-	ALL	ALL	accept

Page 1 of 1 | Show 50 items | Displaying 1 - 3 of 3

User Service Control Section:

Buttons: Add, Edit, Remove, Move

#	Zone	Address	Action
-	ALL	ALL	accept

Page 1 of 1 | Show 50 items | Displaying 1 - 1 of 1

HTTP Section:

- Enable
- Server Port: 80

Buttons: Apply, Reset

Now administrator access to the Web Configurator can only come from the LAN1 zone. Non-admin users can still use HTTPS to log into the ZyWALL from any of the ZyWALL's zones (to use SSL VPN for example).

7.9 How to Allow Incoming H.323 Peer-to-peer Calls

Suppose you have a H.323 device on the LAN1 for VoIP calls and you want it to be able to receive peer-to-peer calls from the WAN. Here is an example of how to configure NAT and the firewall to have the ZyWALL forward H.323 traffic destined

for wan1 IP address 10.0.0.8 to a H.323 device located on the LAN and using IP address 192.168.1.56.

Figure 86 WAN to LAN H.323 Peer-to-peer Calls Example



7.9.1 Turn On the ALG

Click **Configuration > Network > ALG**. Select **Enable H.323 ALG** and **Enable H.323 transformations** and click **Apply**.

Figure 87 Configuration > Network > ALG

The screenshot shows the configuration page for ALG (Application Layer Gateway) settings. The page is divided into three sections: SIP Settings, H.323 Settings, and FTP Settings.

SIP Settings:

- Enable SIP ALG
- Enable SIP Transformations
- Enable Configure SIP Inactivity Timeout
- SIP Media Inactivity Timeout: 120 (seconds)
- SIP Signaling Inactivity Timeout: 1800 (seconds)
- SIP Signaling Port: (table below)

#	Port
1	5060

H.323 Settings:

- Enable H.323 ALG
- Enable H.323 Transformations
- H.323 Signaling Port: 1720 (1025-65535)
- Additional H.323 Signaling Port for Transformations: (Optional)

FTP Settings:

- Enable FTP ALG
- Enable FTP Transformations
- FTP Signaling Port: 21 (1-65535)
- Additional FTP Signaling Port for Transformations: (Optional)

Buttons: Apply, Reset

7.9.2 Set Up a NAT Policy For H.323

In this example, you need a NAT policy to forward H.323 (TCP port 1720) traffic received on the ZyWALL's 10.0.0.8 WAN IP address to LAN1 IP address 192.168.1.56.

- 1 Use **Configuration > Object > Address > Add** to create an address object for the public WAN IP address (called WAN_IP-for-H323 here). Then use it again to create an address object for the H.323 device's private LAN1 IP address (called LAN_H323 here).

Figure 88 Create Address Objects

The figure displays two screenshots of the 'Add Address Rule' dialog box in a network configuration interface. Both dialog boxes have a title bar with a green plus icon, the text 'Add Address Rule', and window control buttons (minimize, maximize, close). The top dialog box is for creating a rule named 'WAN_IP-for-H323'. It has three input fields: 'Name' with the value 'WAN_IP-for-H323', 'Address Type' with a dropdown menu set to 'HOST', and 'IP Address' with the value '10.0.0.3'. The bottom dialog box is for creating a rule named 'LAN_H323'. It has three input fields: 'Name' with the value 'LAN_H323', 'Address Type' with a dropdown menu set to 'HOST', and 'IP Address' with the value '192.168.1.56'. Both dialog boxes have 'OK' and 'Cancel' buttons at the bottom right.

2 Click **Configuration > Network > NAT > Add.**

Configure a name for the rule (WAN-LAN_H323 here).

You want the LAN H.323 device to receive peer-to-peer calls from the WAN and also be able to initiate calls to the WAN so you set the **Classification** to **NAT 1:1**.

Set the **Incoming Interface** to **wan1**.

Set the **Original IP** to the WAN address object (**WAN_IP-for-H323**).

Set the **Mapped IP** to the H.323 device's LAN1 IP address object (**LAN_H323**).

Set the **Port Mapping Type** to **Port**, the **Protocol Type** to **TCP** and the original and mapped ports to 1720.

Click **OK**.

Figure 89 Configuration > Network > NAT > Add

7.9.3 Set Up a Firewall Rule For H.323

The default firewall rule for WAN-to-LAN traffic drops all traffic. Here is how to configure a firewall rule to allow H.323 (TCP port 1720) traffic received on the WAN_IP-for-H323 IP address to go to LAN1 IP address 192.168.1.56.

1 Click **Configuration > Firewall > Add**.

In the **From** field select WAN.

In the **To** field select LAN1.

Configure a name for the rule (WAN-to-LAN_H323 here).

Set the **Destination** to the H.323 device's LAN1 IP address object (**LAN_H323**).

LAN_H323 is the destination because the ZyWALL applies NAT to traffic before applying the firewall rule.

Set the **Service** to **H.323**.

Click **OK**.

Figure 90 Configuration > Firewall > Add

The screenshot shows the 'Add Firewall Rule' dialog box with the following configuration:

- Enable
- From: WAN
- To: LAN1
- Description: WAN-to-LAN_H323 (Optional)
- Schedule: none
- User: any
- Source: any
- Destination: LAN_H323
- Service: H323
- Access: allow
- Log: no

7.10 How to Allow Public Access to a Web Server

This is an example of making an HTTP (web) server in the DMZ zone accessible from the Internet (the WAN zone). In this example you have public IP address 1.1.1.1 that you will use on the **wan1** interface and map to the HTTP server's private IP address of 192.168.3.7.

Figure 91 Public Server Example Network Topology

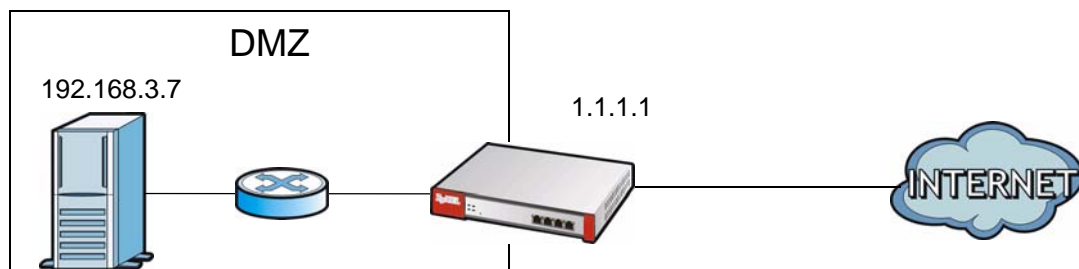

7.10.1 Create the Address Objects

Use **Configuration > Object > Address > Add** to create the address objects.

- 1 Create a host address object named DMZ_HTTP for the HTTP server's private IP address of 192.168.3.7.

Figure 92 Creating the Address Object for the HTTP Server's Private IP Address

The screenshot shows a dialog box titled "Add Address Rule". It has three input fields: "Name" with the value "DMZ_HTTP", "Address Type" with a dropdown menu set to "HOST", and "IP Address" with the value "192.168.3.7". At the bottom of the dialog are "OK" and "Cancel" buttons.

- 2 Create a host address object named Public_HTTP_Server_IP for the public WAN IP address 1.1.1.1.

Figure 93 Creating the Address Object for the Public IP Address

The screenshot shows a dialog box titled "Add Address Rule". It has three input fields: "Name" with the value "Public_HTTP_Server_IP", "Address Type" with a dropdown menu set to "HOST", and "IP Address" with the value "1.1.1.1". At the bottom of the dialog are "OK" and "Cancel" buttons.

7.10.2 Configure NAT

You need a NAT rule to send HTTP traffic coming to IP address 1.1.1.1 on **wan1** to the HTTP server's private IP address of 192.168.3.7. In the **Configuration > Network > NAT** screen, click the **Add** icon and create a new NAT entry as follows.

- Set the **Incoming Interface** to **wan1**.
- Set the **Original IP** to the **Public_HTTP_Server_IP** object and the **Mapped IP** to the **DMZ_HTTP** object.
- HTTP traffic and the HTTP server in this example both use TCP port 80. So you set the **Port Mapping Type** to **Port**, the **Protocol Type** to **TCP**, and the original and mapped ports to 80.

- Keep **Enable NAT Loopback** selected to allow users connected to other interfaces to access the HTTP server (see [NAT Loopback on page 343](#) for details).

Figure 94 Creating the NAT Entry

The screenshot shows the 'Add NAT' configuration window. The 'General Settings' section has 'Enable Rule' checked and 'Rule Name' set to 'DMZ_HTTP'. The 'Port Mapping Type' section has 'Virtual Server' selected. The 'Mapping Rule' section has 'Incoming Interface' set to 'wan2', 'Original IP' set to 'Public_HTTP_Server_IP', 'Mapped IP' set to 'DMZ_HTTP', 'Port Mapping Type' set to 'Port', 'Protocol Type' set to 'TCP', 'Original Port' set to '80', and 'Mapped Port' set to '80'. The 'Related Settings' section has 'Enable NAT Loopback' checked. There are 'OK' and 'Cancel' buttons at the bottom right.

7.10.3 Set Up a Firewall Rule

The firewall blocks traffic from the WAN zone to the DMZ zone by default so you need to create a firewall rule to allow the public to send HTTP traffic to IP address 1.1.1.1 in order to access the HTTP server. If a domain name is registered for IP address 1.1.1.1, users can just go to the domain name to access the web server.

- 1 Click **Configuration > Firewall > Add**. Set the **From** field as **WAN** and the **To** field as **DMZ**. Set the **Destination** to the HTTP server's DMZ IP address object (**DMZ_HTTP**). **DMZ_HTTP** is the destination because the ZyWALL applies NAT to traffic before applying the firewall rule. Set the **Access** field to **allow** and the **Service** to **HTTP**, and click **OK**.

Figure 95 Configuration > Firewall > Add

The screenshot shows the 'Add Firewall Rule' dialog box with the following configuration:

- Enable
- From: WAN
- To: DMZ
- Description: (Optional)
- Schedule: none
- User: any
- Source: any
- Destination: DMZ_HTTP
- Service: HTTP
- Access: allow
- Log: no

At the bottom, there are 'OK' and 'Cancel' buttons, and a status bar showing 'Page 1 of 1' and 'Show 50 items'.

7.11 How to Use an IPPBX on the DMZ

This is an example of making an IPPBX x6004 using SIP in the DMZ zone accessible from the Internet (the WAN zone). In this example you have public IP

address 1.1.1.2 that you will use on the **wan1** interface and map to the IPPBX's private IP address of 192.168.3.7. The local SIP clients are on the LAN.

Figure 96 IPPBX Example Network Topology

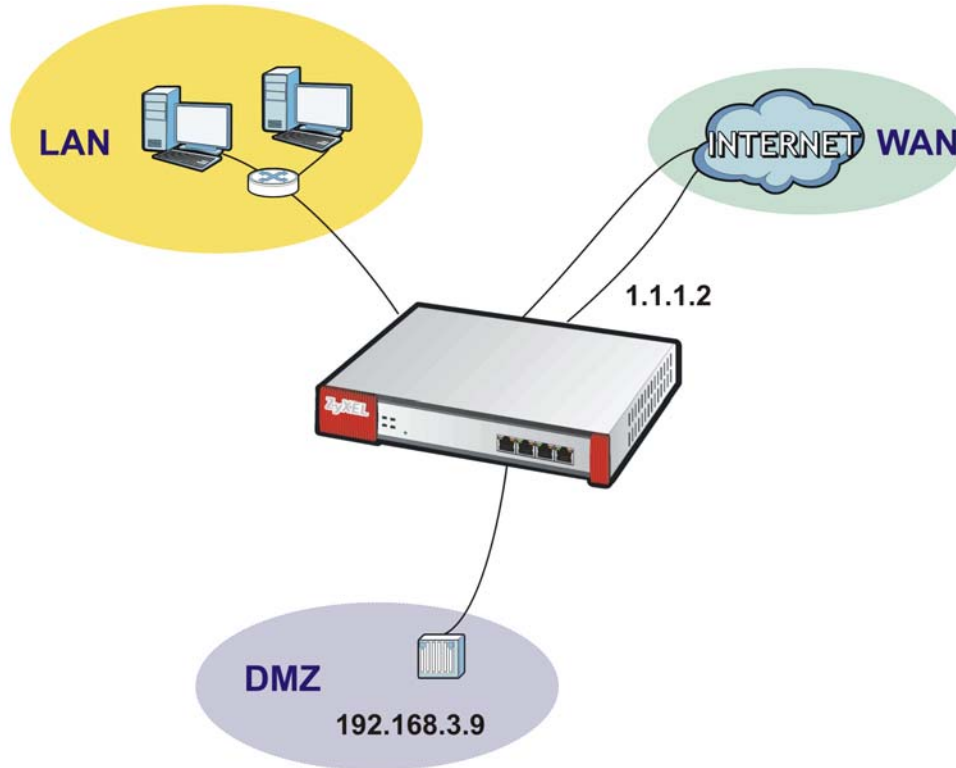

7.11.1 Turn On the ALG

Click **Configuration > Network > ALG**. Select **Enable SIP ALG** and **Enable SIP Transformations** and click **Apply**.

Figure 97 Configuration > Network > ALG

The screenshot shows the ALG configuration page with the following settings:

- SIP Settings:**
 - Enable SIP ALG
 - Enable SIP Transformations
 - Enable Configure SIP Inactivity Timeout
 - SIP Media Inactivity Timeout: 120 (seconds)
 - SIP Signaling Inactivity Timeout: 1800 (seconds)
 - SIP Signaling Port:

#	Port
1	5060
- H.323 Settings:**
 - Enable H.323 ALG
 - Enable H.323 Transformations
 - H.323 Signaling Port: 1720 (1025-65535)
 - Additional H.323 Signaling Port for Transformations: (1025-65535) (Optional)
- FTP Settings:**
 - Enable FTP ALG
 - Enable FTP Transformations
 - FTP Signaling Port: 21 (1-65535)
 - Additional FTP Signaling Port for Transformations: (1-65535) (Optional)

Buttons: Apply, Reset

7.11.2 Create the Address Objects

Use **Configuration > Object > Address > Add** to create the address objects.

- 1 Create a host address object named IPPBX-DMZ for the IPPBX's private DMZ IP address of 192.168.3.9.

Figure 98 Creating the Address Object for the IPPBX's Private IP Address

The screenshot shows the "Add Address Rule" dialog box with the following fields:

- Name: IPPBX-DMZ
- Address Type: HOST
- IP Address: 192.168.3.9

Buttons: OK, Cancel

- 2 Create a host address object named IPPBX-Public for the public WAN IP address 1.1.1.2.

Figure 99 Creating the Public IP Address Object



7.11.3 Setup a NAT Policy for the IPPBX

Click **Configuration > Network > NAT > Add**.

- Configure a name for the rule (WAN-DMZ_IPPBX here).
- You want the IPPBX to receive calls from the WAN and also be able to send calls to the WAN so you set the **Classification** to **NAT 1:1**.
- Set the **Incoming Interface** to **wan1**.
- Set the **Original IP** to the WAN address object (**IPPBX-Public**). If a domain name is registered for IP address 1.1.1.2, users can use it to connect to for making SIP calls.
- Set the **Mapped IP** to the IPPBX's DMZ IP address object (**IPPBX-DMZ**).
- Set the **Port Mapping Type** to **Port**, the **Protocol Type** to **UDP** and the original and mapped ports to 5060.
- Keep **Enable NAT Loopback** selected to allow the LAN users to use the IPPBX (see [NAT Loopback on page 343](#) for details).

- Click **OK**.

Figure 100 Configuration > Network > NAT > Add

Add NAT

Create new Object ▾

General Settings

Enable Rule
Rule Name: WAN-DMZ_IPPBX

Port Mapping Type

Classification: Virtual Server 1:1 NAT Many 1:1 NAT

Mapping Rule

Incoming Interface: wan1 ▾
Original IP: IPPBX-Public ▾
Mapped IP: IPPBX-DMZ ▾
Port Mapping Type: Port ▾
Protocol Type: UDP ▾
Original Port: 5060
Mapped Port: 5060

Related Settings

Enable NAT Loopback ⓘ

OK Cancel

7.11.4 Set Up a WAN to DMZ Firewall Rule for SIP

The firewall blocks traffic from the WAN zone to the DMZ zone by default so you need to create a firewall rule to allow the public to send SIP traffic to the IPPBX. If a domain name is registered for IP address 1.1.1.2, users can use it to connect to for making SIP calls.

- 1 Click **Configuration > Firewall > Add**. Set the **From** field as **WAN** and the **To** field as **DMZ**. Set the **Destination** to the IPPBX's DMZ IP address object (**DMZ_SIP**). **IPPBX_DMZ** is the destination because the ZyWALL applies NAT to traffic before applying the firewall rule. Set the **Access** field to **allow** and click **OK**.

Figure 101 Configuration > Firewall > Add

The screenshot shows the 'Add Firewall Rule' dialog box with the following configuration:

Field	Value
Enable	<input checked="" type="checkbox"/>
From:	WAN
To:	DMZ
Description:	(Optional)
Schedule:	none
User:	any
Source:	any
Destination:	IPPBX-DMZ
Service:	any
Access:	allow
Log:	no

7.11.5 Set Up a DMZ to LAN Firewall Rule for SIP

The firewall blocks traffic from the DMZ zone to the LAN zone by default so you need to create a firewall rule to allow the IPPBX to send SIP traffic to the SIP clients on the LAN.

- 1 Click **Configuration > Firewall > Add**. Set the **From** field as **DMZ** and the **To** field as **LAN**. Set the **Destination** to the IPPBX's DMZ IP address object (**DMZ_SIP**). Set the **Source** to **IPPBX_DMZ**. Leave the **Access** field to **allow** and click **OK**.

Figure 102 Configuration > Firewall > Add

The screenshot shows the 'Add Firewall Rule' dialog box with the following configuration:

- Enable
- From: DMZ
- To: LAN
- Description: (Optional)
- Schedule: none
- User: any
- Source: IPPBX-DMZ
- Destination: any
- Service: any
- Access: allow
- Log: no

Buttons: OK, Cancel

7.12 How to Use Multiple Static Public WAN IP Addresses for LAN to WAN Traffic

If your ISP gave you a range of static public IP addresses, here is how to configure a policy route to have the ZyWALL use them for traffic it sends out from the LAN.

7.12.1 Create the Public IP Address Range Object

Click **Configuration > Object > Address > Add** to create the address object that represents the range of static public IP addresses. In this example you name it **Public-IPs** and it goes from **1.1.1.10** to **1.1.1.17**.

Figure 103 Creating the Public IP Address Range Object

The screenshot shows the 'Add Address Rule' dialog box with the following configuration:

- Name: Public-IPs
- Address Type: RANGE
- Starting IP Address: 1.1.1.10
- End IP Address: 1.1.1.17

Buttons: OK, Cancel

7.12.2 Configure the Policy Route

Now you need to configure a policy route that has the ZyWALL use the range of public IP addresses as the source address for WAN to LAN traffic.

Click **Configuration > Network > Routing > Add**.

Although adding a description is optional, it is recommended. This example uses LAN-to-WAN-Range.

Specifying a **Source Address** is also optional although recommended. This example uses LAN_SUBNET1.

Set the **Source Network Address Translation** to **Public-IPs** and click **OK**.

Figure 104 Configuring the Policy Route

7.13 How to Set Up a Wireless LAN

This tutorial applies only to USG 20W.

You can configure different interfaces to use on the wireless LAN card. This lets you have different wireless LAN networks using different SSIDs. You can configure

the WLAN interfaces before or after you install the wireless LAN card. This example shows how to create a WLAN interface that uses WPA or WPA2 security and the ZyWALL's local user database for authentication.

7.13.1 Set Up User Accounts

The ZyWALL supports TTLS using PAP so you can use the ZyWALL's local user database with WPA or WPA2 instead of needing an external RADIUS server. For each WLAN user, set up a user account containing the user name and password the WLAN user needs to enter to connect to the wireless LAN.

- 1 Click **Configuration > Object > User/Group > User** and the **Add** icon.
- 2 Set the **User Name** to `wlan_user`. Enter (and re-enter) the user's password. Click **OK**.

Figure 105 Configuration > Object > User/Group > User > Add

The screenshot shows a window titled "Edit User wlan-user". The "User Configuration" section contains the following fields and options:

- User Name:** wlan_user
- User Type:** user (dropdown menu)
- Password:** [masked with dots]
- Retype:** [masked with dots]
- Description:** Local User
- Authentication Timeout Settings:**
 - Use Default Settings
 - Use Manual Settings
- Lease Time:** 1440 minutes
- Reauthentication Time:** 1440 minutes

At the bottom right, there are "OK" and "Cancel" buttons.

- 3 Use the **Add** icon in the **Configuration > Object > User/Group > User** screen to set up the remaining user accounts in similar fashion.

7.13.2 Create the WLAN Interface

- 1 Click **Configuration > Network > Interface > WLAN > Add** to open the **WLAN Add** screen.

2 Edit this screen as follows.

A (internal) name for the WLAN interface displays. You can modify it if you want to.

The ZyWALL's security settings are configured by zones. Select to which security zone you want the WLAN interface to belong (the WLAN zone in this example). This determines which security settings the ZyWALL applies to the WLAN interface.

Configure the **SSID** (ZYXEL_WPA in this example).

If all of your wireless clients support WPA2, select **WPA2-Enterprise** as the **Security Type**, otherwise select **WPA/WPA-2-Enterprise**. Set the **Authentication Type** to **Auth Method**. The ZyWALL can use its default authentication method (the local user database) and its default certificate to authenticate the users.

Configure the interface's IP address and set it to **DHCP Server**. Click **OK**.

Figure 106 Configuration > Network > Interface > WLAN > Add

Add WLAN

Show Advanced Settings

General Settings

Enable Interface

Interface Name: wlan-1-2

Description: (Optional)

Zone: Please select one ...

Virtual Access Point Settings

SSID: ZYXEL_WPA

Hide SSID Broadcast

Block Intra BSS Traffic

Maximum Associations: 255

WLAN Security Settings

Security Type: WPA2-Enterprise

Authentication Type: Auth Method

Authentication Method: default

TLS Certificate: default

IP Address Assignment

IP Address: 10.1.1.1

Subnet Mask: 255.255.0.0

Interface Parameters

Egress Bandwidth: 1048576 Kbps

DHCP Setting

DHCP: DHCP Server

IP Pool Start Address (Optional): Pool Size:

First DNS Server (Optional): Custom Defined

Apply Reset OK Cancel

- 3 Turn on the wireless LAN and click **Apply**.

Figure 107 Configuration > Network > Interface > WLAN

The screenshot shows the ZyWALL configuration interface for the WLAN interface. The 'WLAN Device Settings' section is visible, showing 'Extension Slot' set to 'slot1', '802.11 Band' set to 'b+g', and 'Channel' set to '6'. The 'Enable WLAN Device' checkbox is checked and highlighted with a red circle. Below this is an 'Interface Summary' table with two entries.

#	Statu	Name	SSID	IP Address	Mask	Security
1	🔆	wlan-1-1	ZyXEL01	10.59.1.1	255.255.255.0	none
2	🔆	wlan-1-2	ZYXEL_WF	10.1.1.1	255.255.0.0	wpa2-aes-eap

7.13.3 Set Up the Wireless Clients to Use the WLAN Interface

The following sections show you how to have a wireless client (not included with the ZyWALL) use the wireless network.

7.13.3.1 Configure the ZyXEL Wireless Client Utility

This example covers how to configure ZyXEL's wireless client utility (not included with the ZyWALL) to use the WLAN interface. See [Section 7.13.3.2 on page 154](#) instead for how to use Funk Odyssey's wireless client software if you want the wireless client to validate the ZyWALL's certificate (for added protection against connecting to a rogue AP).

- 1 Open the wireless client utility and click **Profile**.

Figure 108 ZyXEL Wireless Client

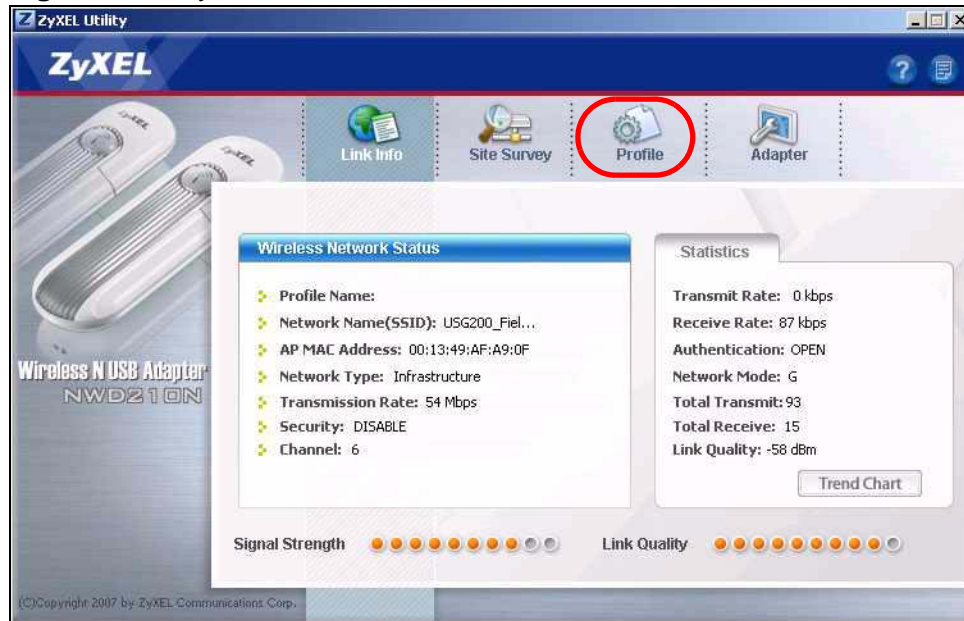

- 2 Add a new profile. This example uses "ZYXEL_WPA" as the name. It is also the SSID (name) of the wireless network. Select **Infrastructure** and click **Next**.

Figure 109 ZyXEL Wireless Client > Profile

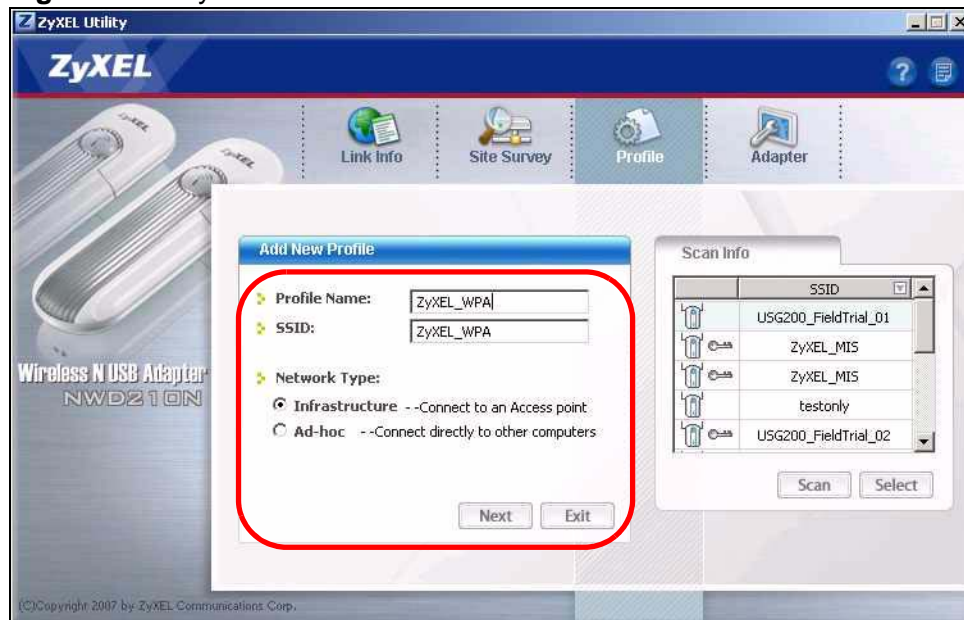

- 3 Select **WPA2** as the security type and click **Next**.

Figure 110 ZyXEL Wireless Client > Profile: Security Type

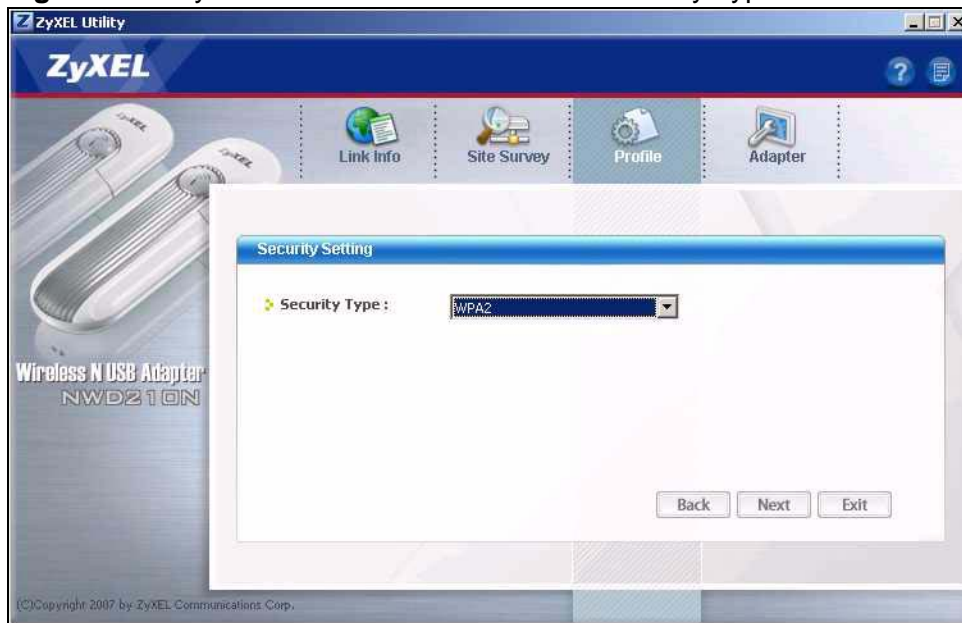

- 4 Set the encryption type to **TKIP** and the EAP type to **TTLS**. Configure **wlan_user** as the **Login Name** and enter the account's password (also **wlan_user** in this example). In **TTLS Protocol**, select **PAP**. Click **Next**.

Figure 111 ZyXEL Wireless Client > Profile: Security Settings

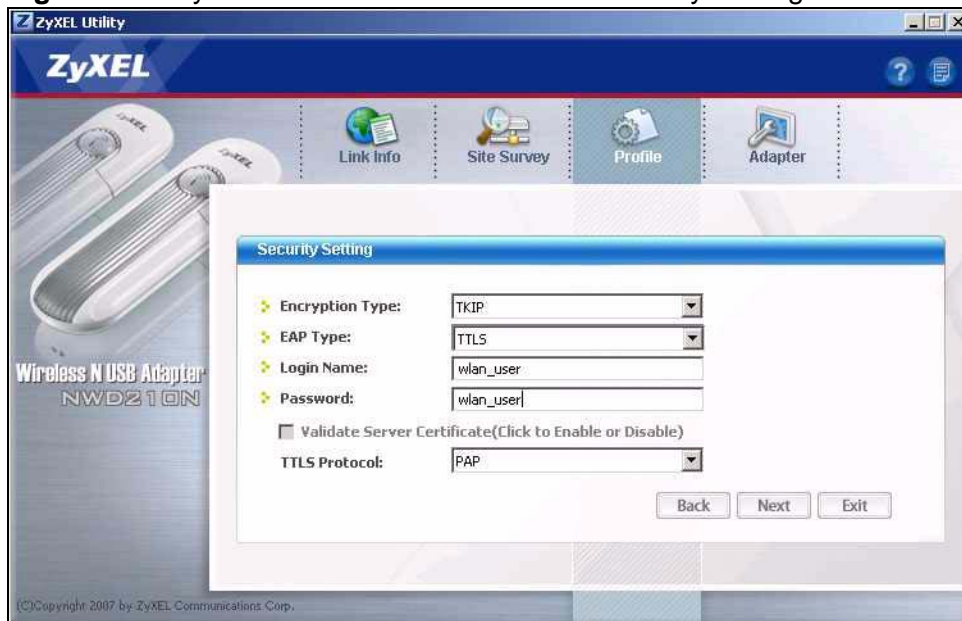

- 5 Confirm your settings and click **Save**.

Figure 112 ZyXEL Wireless Client > Profile: Save

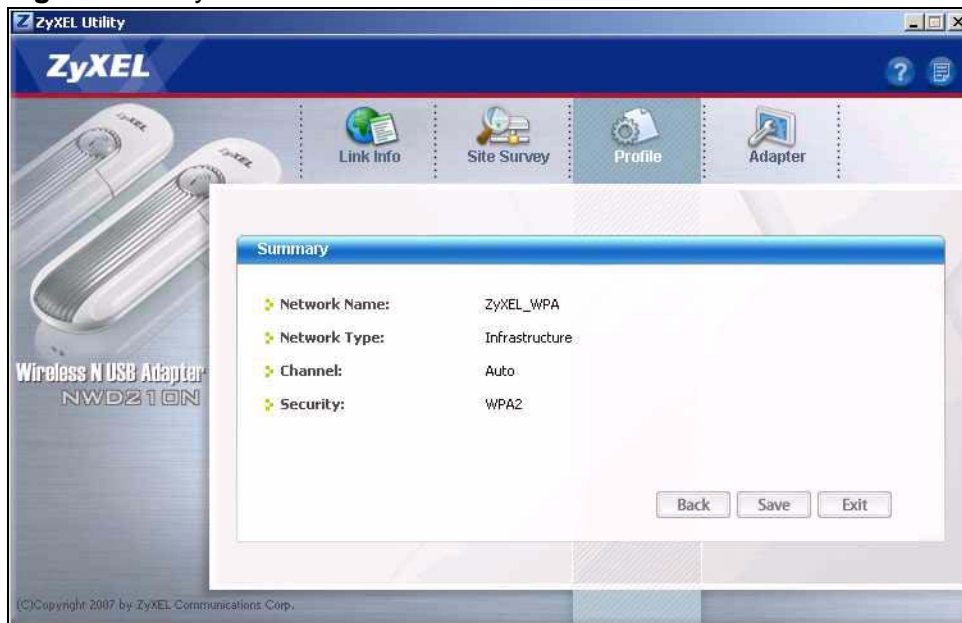

- 6 Click **Activate Now**.

Figure 113 ZyXEL Wireless Client > Profile: Activate



- The ZYXEL_WPA profile displays in your list of profiles.

Figure 114 ZyXEL Wireless Client > Profile: Activate

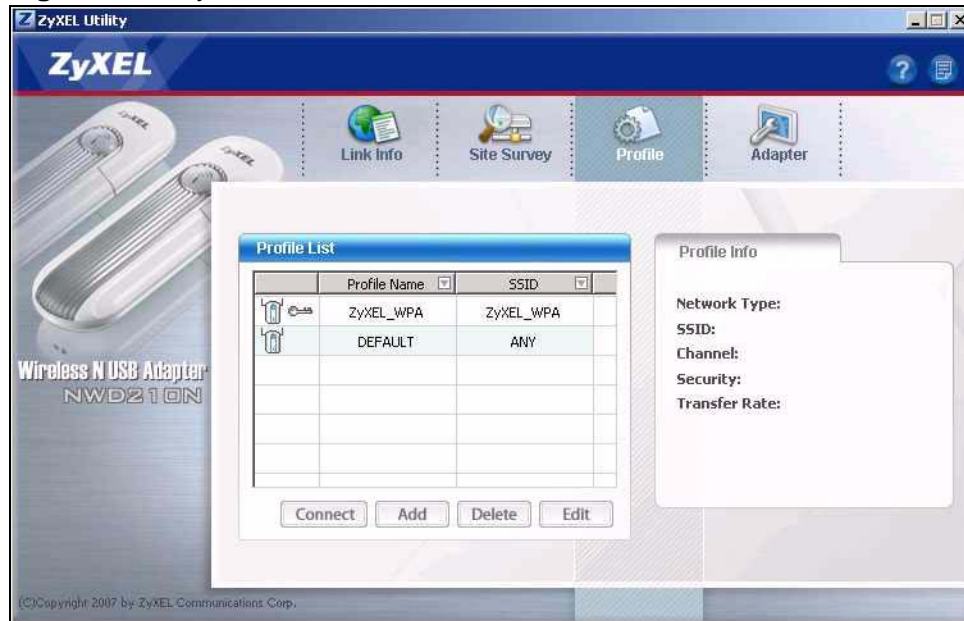

Since the ZyXEL utility does not have the wireless client validate the ZyWALL's certificate, you can go to [Section 7.13.3.4 on page 162](#).

7.13.3.2 Configure the Funk Odyssey Wireless Client

This example shows how to configure Funk's Odyssey Access Client Manager wireless client software (not included with the ZyWALL) to use the WLAN interface.

- Open the Odyssey wireless client software and click **Profiles > Add**.

Figure 115 Odyssey Access Client Manager > Profiles

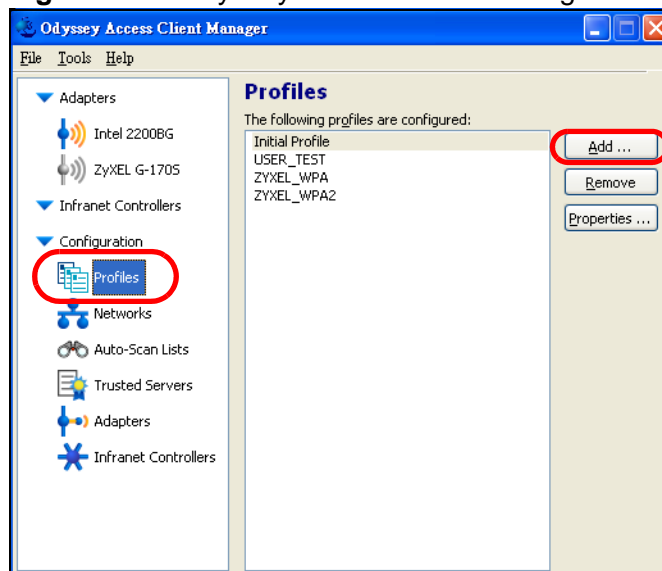

- 2 Name the profile (this example uses **ZYXEL_WPA**). In the **User Info** tab, configure **wlan_user** as the **Login name**. In the **Password** sub-tab, select **Prompt for long name and password**.

Figure 116 Odyssey Access Client Manager > Profiles > User Info

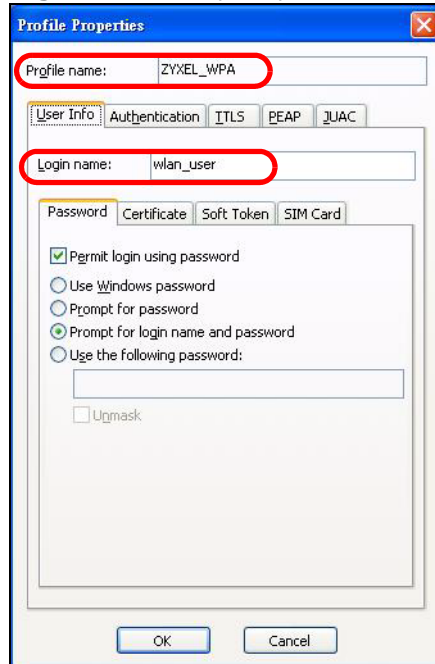

- 3 Click the **Authentication** tab and select **Validate server certificate**.

Figure 117 Odyssey Access Client Manager > Profiles > Authentication

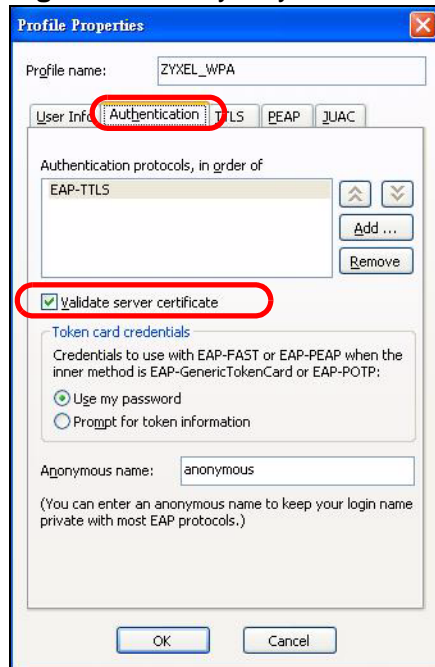

- Click the **TTLS** tab and select **PAP**. Then click **OK**.

Figure 118 Odyssey Access Client Manager > Profiles > Authentication

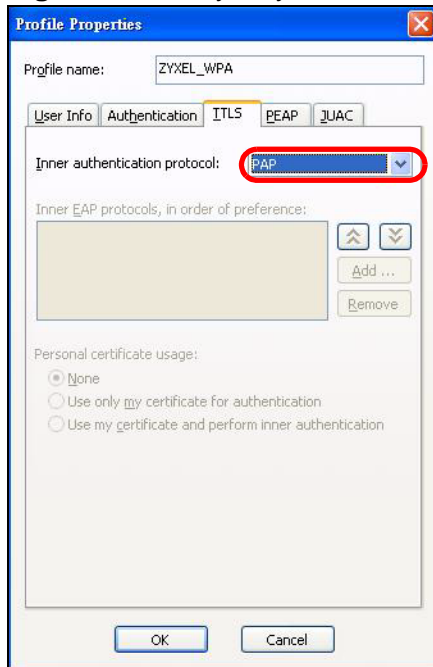

- Click **Networks > Add**.

Figure 119 Odyssey Access Client Manager > Networks

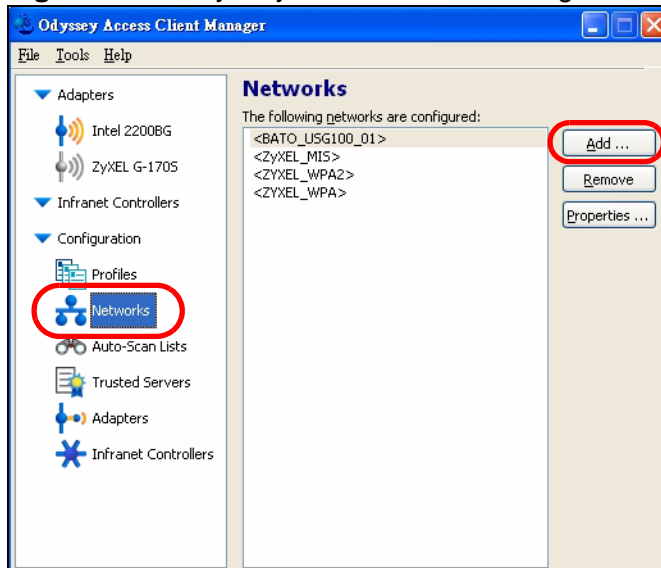

- 6 Enter the name of the wireless network ("ZYXEL_WPA" in this example) or click **Scan** to look for it. Then select **Authenticate using profile** and select the profile you configured ("ZYXEL_WPA" in this example). Click **OK**.

Figure 120 Odyssey Access Client Manager > Networks > Add

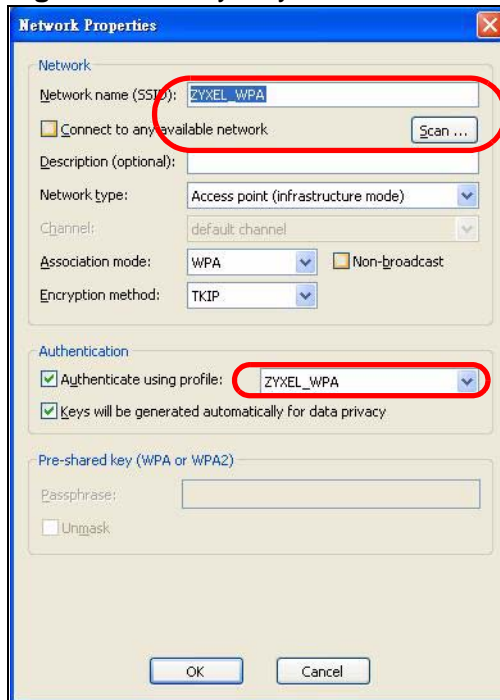

Use the next section to import the ZyWALL's certificate into the wireless client.

7.13.3.3 Wireless Clients Import the ZyWALL's Certificate

You must import the ZyWALL's certificate into the wireless clients if they are to validate the ZyWALL's certificate. Use the **Configuration > Object > Certificate > Edit** screen (see [Section 39.2.2 on page 599](#)) to export the certificate the ZyWALL is using for the WLAN interface. Then do the following to import the certificate into each wireless client computer.

- 1 In Internet Explorer, click **Tools > Internet Options > Content** and click the **Certificates** button.

Figure 121 Internet Explorer: Tools > Internet Options > Content

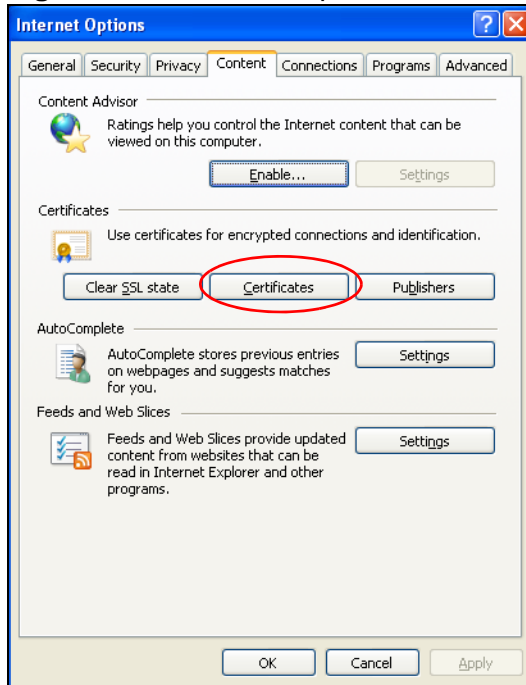

- 2 Click **Import**.

Figure 122 Internet Explorer: Tools > Internet Options > Content > Certificates

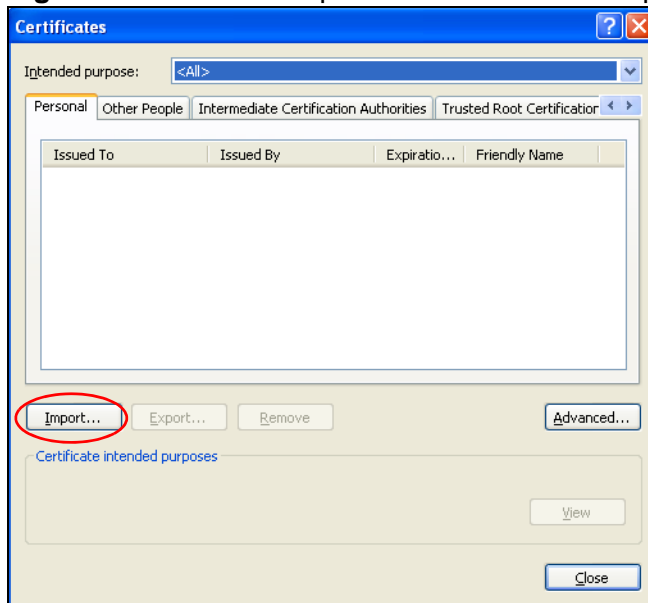

- 3 Use the wizard screens to import the certificate. You may need to change the **Files of Type** setting to **All Files** in order to see the certificate file.

Figure 123 Internet Explorer Certificate Import Wizard File Open Screen

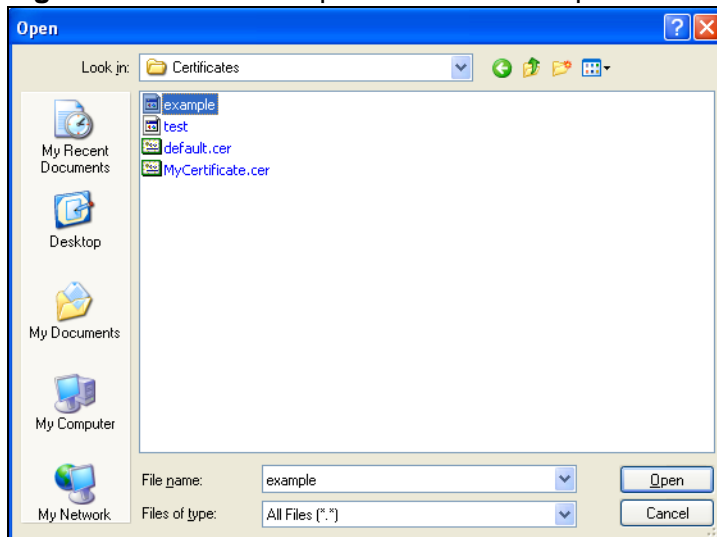

- 4 When you get to the **Certificate Store** screen, select the option to automatically select the certificate store based on the type of certificate.

Figure 124 Internet Explorer Certificate Import Wizard Certificate Store Screen

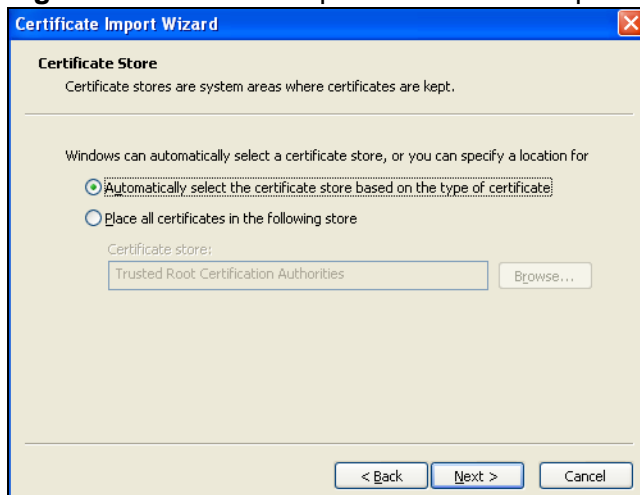

- 5 If you get a security warning screen, click **Yes** to proceed.

Figure 125 Internet Explorer Certificate Import Certificate Warning Screen

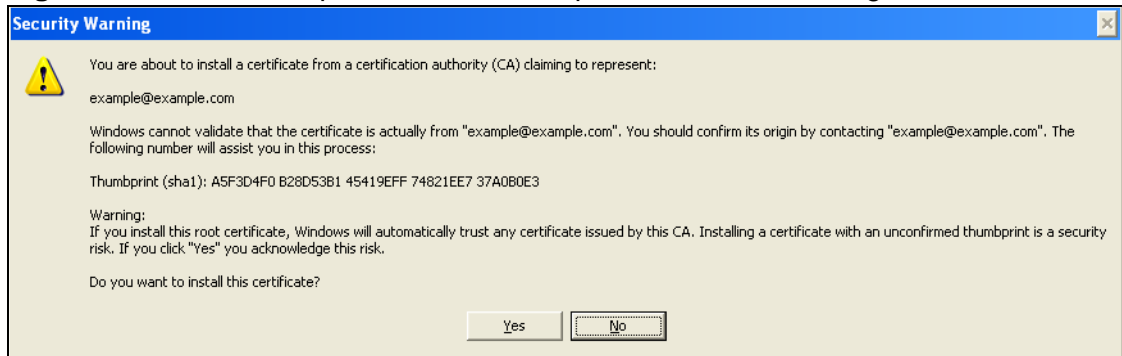

- 6 The **Internet Explorer Certificates** screen remains open after the import is done. You can see the newly imported certificate listed in the **Trusted Root Certification Authorities** tab. The values in the **Issued To** and **Issued By** fields should match those in the ZyWALL's **My Certificates** screen's **Subject** and **Issuer** fields (respectively).

Figure 126 Internet Explorer: Trusted Root Certification Authorities

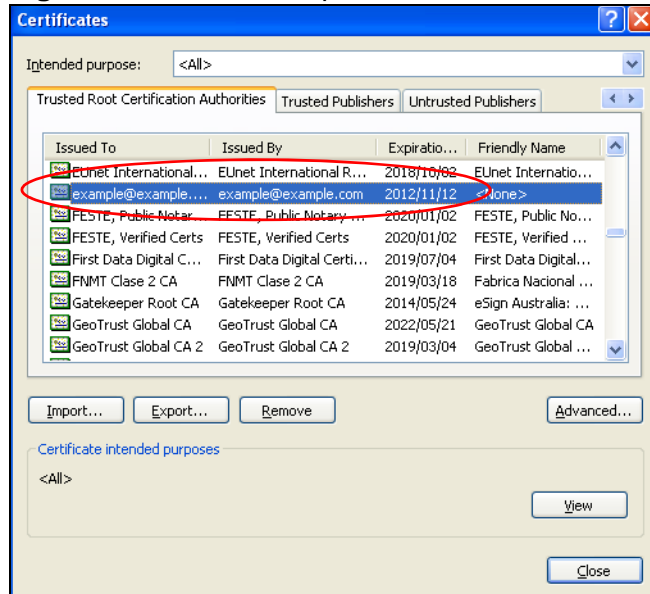

The **My Certificates** screen indicates what type of information is being displayed, such as Common Name (CN), Organizational Unit (OU), Organization (O) and Country (C).

Figure 127 Configuration > Object > Certificate > My Certificates

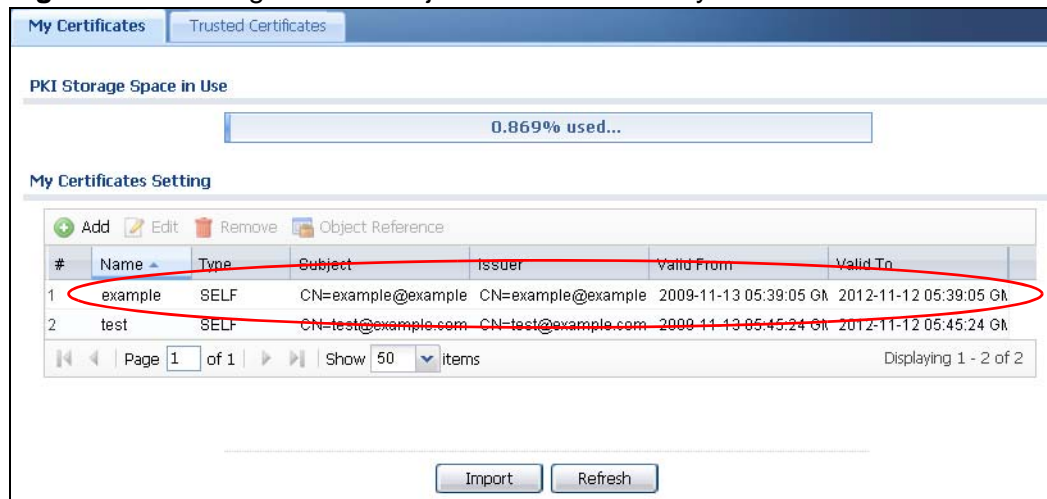

Repeat the steps to import the certificate into each wireless client computer that is to validate the ZyWALL's certificate when using the WLAN interface.

7.13.3.4 Wireless Clients Use the WLAN Interface

A login screen displays when the wireless client attempts to connect to the wireless interface. Enter the username and password and click **OK**.

Funk Odyssey Access Wireless Client Login Example

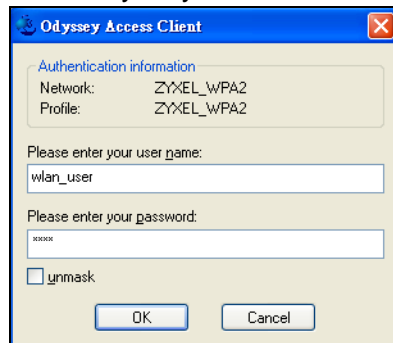

The screenshot shows a dialog box titled "Odyssey Access Client". It contains the following elements:

- Authentication information:**
 - Network: ZYXEL_WPA2
 - Profile: ZYXEL_WPA2
- Please enter your user name:** A text input field containing "wlan_user".
- Please enter your password:** A text input field containing "xxxxx".
- unmask
- Buttons:** "OK" and "Cancel".

PART II

Technical Reference

Dashboard

8.1 Overview

Use the **Dashboard** screens to check status information about the ZyWALL.

8.1.1 What You Can Do in this Chapter

Use the **Dashboard** screens for the following.

- Use the main **Dashboard** screen (see [Section 8.2 on page 165](#)) to see the ZyWALL's general device information, system status, system resource usage, licensed service status, and interface status. You can also display other status screens for more information.
- Use the **VPN** status screen (see [Section 8.2.1 on page 171](#)) to look at the VPN tunnels that are currently established.
- Use the **DHCP Table** screen (see [Section 8.2.5 on page 174](#)) to look at the IP addresses currently assigned to DHCP clients and the IP addresses reserved for specific MAC addresses.
- Use the **Current Users** screen (see [Section 8.2.6 on page 175](#)) to look at a list of the users currently logged into the ZyWALL.

8.2 The Dashboard Screen

The **Dashboard** screen displays when you log into the ZyWALL or click **Dashboard** in the navigation panel. The dashboard displays general device information, system status, system resource usage, licensed service status, and

interface status in widgets that you can re-arrange to suit your needs. You can also collapse, refresh, and close individual widgets.

Figure 128 Dashboard

USG 20

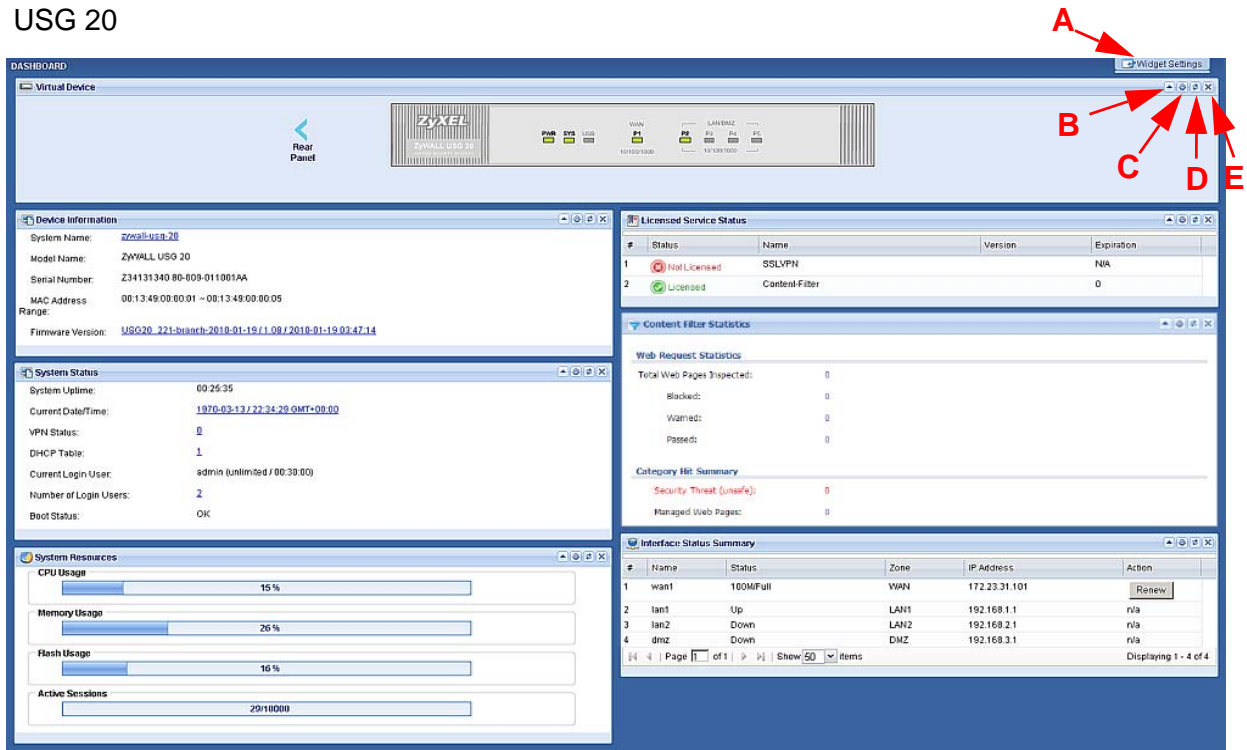

USG 20W

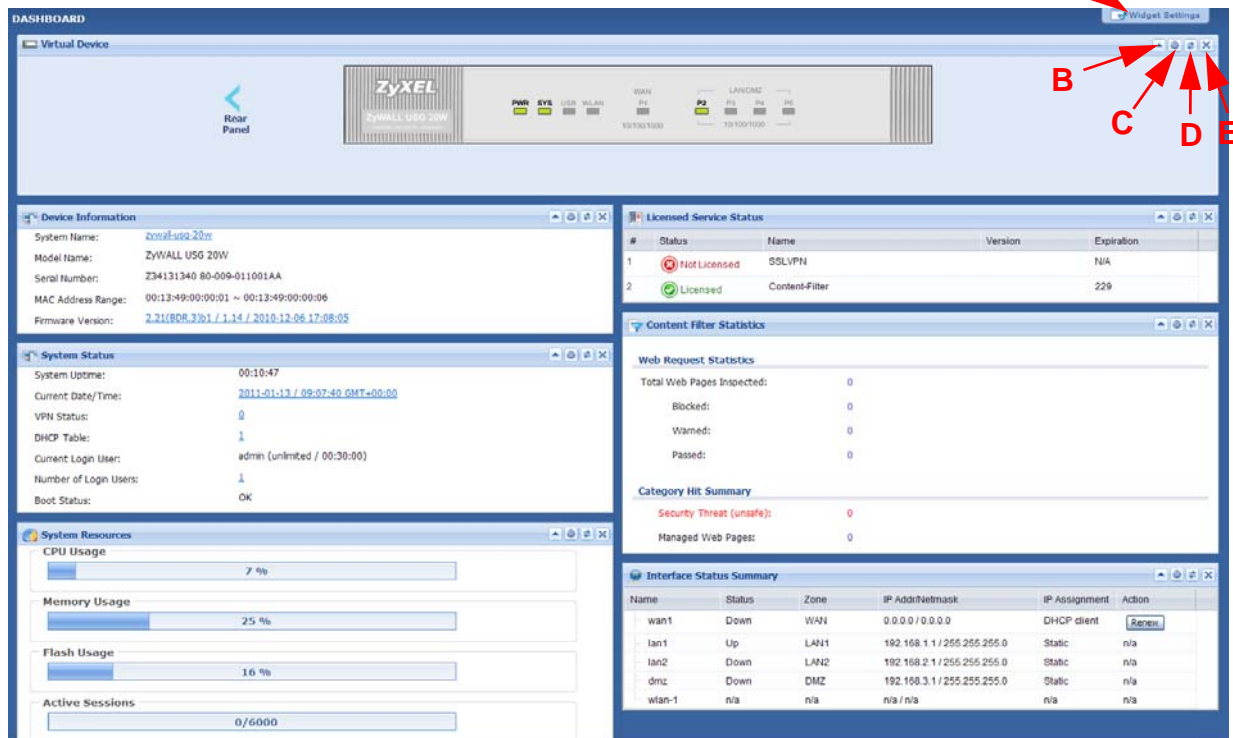

The following table describes the labels in this screen.

Table 19 Dashboard

LABEL	DESCRIPTION
Widget Setting (A)	Use this link to re-open closed widgets. Widgets that are already open appear grayed out.
Up Arrow (B)	Click this to collapse a widget.
Refresh Time Setting (C)	Set the interval for refreshing the information displayed in the widget.
Refresh Now (D)	Click this to update the widget's information immediately.
Close this Module (E)	Click this to close the widget. Use Widget Setting to re-open it.
Virtual Device	
Rear Panel	Click this to view details about the ZyWALL's rear panel. Hover your cursor over a connected interface or slot to display status details.
Front Panel	Click this to view details about the status of the ZyWALL's front panel LEDs and connections. See Section 1.3.1 on page 32 for LED descriptions. An unconnected interface or slot appears grayed out.
	The following front and rear panel labels display when you hover your cursor over a connected interface or slot.
Name	This field displays the name of each interface.
Slot	This field displays the name of each extension slot.

Table 19 Dashboard (continued)

LABEL	DESCRIPTION
Device	This field displays the name of the device connected to the extension slot (or none if no device is detected).
Status	This field displays the current status of each interface or device installed in a slot. The possible values depend on what type of interface it is. For Ethernet interfaces: Inactive - The Ethernet interface is disabled. Down - The Ethernet interface does not have any physical ports associated with it or the Ethernet interface is enabled but not connected. Speed / Duplex - The Ethernet interface is enabled and connected. This field displays the port speed and duplex setting (Full or Half). (For USG 20W only) The status for an installed WLAN card is none . For cellular (3G) interfaces, see Section 11.5 on page 239 for the status that can appear.
Zone	This field displays the zone to which the interface is currently assigned.
IP Address/ Mask	This field displays the current IP address and subnet mask assigned to the interface. If the interface is a member of an active virtual router, this field displays the IP address it is currently using. This is either the static IP address of the interface (if it is the master) or the management IP address (if it is a backup).
Device	This identifies a device installed in one of the ZyWALL's extension slots or USB ports.
Device Information	
System Name	This field displays the name used to identify the ZyWALL on any network. Click the icon to open the screen where you can change it. See Section 43.2 on page 630 .
Model Name	This field displays the model name of this ZyWALL.
Serial Number	This field displays the serial number of this ZyWALL.
MAC Address Range	This field displays the MAC addresses used by the ZyWALL. Each physical port has one MAC address. The first MAC address is assigned to physical port 1, the second MAC address is assigned to physical port 2, and so on.
Firmware Version	This field displays the version number and date of the firmware the ZyWALL is currently running. Click the icon to open the screen where you can upload firmware. See Section 45.3 on page 700 .
System Status	
System Uptime	This field displays how long the ZyWALL has been running since it last restarted or was turned on.
Current Date/Time	This field displays the current date and time in the ZyWALL. The format is yyyy-mm-dd hh:mm:ss.
VPN Status	Click this to look at the VPN tunnels that are currently established. See Section 8.2.1 on page 171 .

Table 19 Dashboard (continued)

LABEL	DESCRIPTION
DHCP Table	Click this to look at the IP addresses currently assigned to the ZyWALL's DHCP clients and the IP addresses reserved for specific MAC addresses. See Section 8.2.5 on page 174 .
Current Login User	This field displays the user name used to log in to the current session, the amount of reauthentication time remaining, and the amount of lease time remaining. See Chapter 33 on page 539 .
Number of Login Users	This field displays the number of users currently logged in to the ZyWALL. Click the icon to pop-open a list of the users who are currently logged in to the ZyWALL. See Section 8.2.6 on page 175 .
Boot Status	<p>This field displays details about the ZyWALL's startup state.</p> <p>OK - The ZyWALL started up successfully.</p> <p>Firmware update OK - A firmware update was successful.</p> <p>Problematic configuration after firmware update - The application of the configuration failed after a firmware upgrade.</p> <p>System default configuration - The ZyWALL successfully applied the system default configuration. This occurs when the ZyWALL starts for the first time or you intentionally reset the ZyWALL to the system default settings.</p> <p>Fallback to lastgood configuration - The ZyWALL was unable to apply the startup-config.conf configuration file and fell back to the lastgood.conf configuration file.</p> <p>Fallback to system default configuration - The ZyWALL was unable to apply the lastgood.conf configuration file and fell back to the system default configuration file (system-default.conf).</p> <p>Booting in progress - The ZyWALL is still applying the system configuration.</p>
System Resources	
CPU Usage	This field displays what percentage of the ZyWALL's processing capability is currently being used. Hover your cursor over this field to display the Show CPU Usage icon that takes you to a chart of the ZyWALL's recent CPU usage.
Memory Usage	This field displays what percentage of the ZyWALL's RAM is currently being used. Hover your cursor over this field to display the Show Memory Usage icon that takes you to a chart of the ZyWALL's recent memory usage.
Flash Usage	This field displays what percentage of the ZyWALL's onboard flash memory is currently being used.
Active Sessions	This field displays how many traffic sessions are currently open on the ZyWALL. These are the sessions that are traversing the ZyWALL. Hover your cursor over this field to display icons. Click the Detail icon to go to the Session Monitor screen to see details about the active sessions. Click the Show Active Sessions icon to display a chart of ZyWALL's recent session usage.

Table 19 Dashboard (continued)

LABEL	DESCRIPTION
Interface Status Summary	If an Ethernet interface does not have any physical ports associated with it, its entry is displayed in light gray text. Click the Detail icon to go to a (more detailed) summary screen of interface statistics.
#	This shows how many interfaces there are.
Name	This field displays the name of each interface.
Status	This field displays the current status of each interface. The possible values depend on what type of interface it is. For Ethernet interfaces: Inactive - The Ethernet interface is disabled. Down - The Ethernet interface does not have any physical ports associated with it or the Ethernet interface is enabled but not connected. Speed / Duplex - The Ethernet interface is enabled and connected. This field displays the port speed and duplex setting (Full or Half). (For USG 20W only) The status for an installed WLAN card is none . For cellular (3G) interfaces, see Section 9.11 on page 195 for the status that can appear.
Zone	This field displays the zone to which the interface is currently assigned.
IP Address	This field displays the current IP address assigned to the interface. If the IP address is 0.0.0.0, the interface is disabled or did not receive an IP address and subnet mask via DHCP. If this interface is a member of an active virtual router, this field displays the IP address it is currently using. This is either the static IP address of the interface (if it is the master) or the management IP address (if it is a backup).
Action	Use this field to get or to update the IP address for the interface. Click Renew to send a new DHCP request to a DHCP server. Click the Connect icon to have the ZyWALL try to connect a PPPoE/PPTP interface. If the interface cannot use one of these ways to get or to update its IP address, this field displays n/a . Click the Disconnect icon to stop a PPPoE/PPTP connection.
Extension Slot	This section of the screen displays the status of the extension card slot and the USB ports.
Slot	This field displays the name of each extension slot.
Device	This field displays the name of the device connected to the extension slot (or none if no device is detected).
Status	For cellular (3G) interfaces, see Section 9.11 on page 195 for the status that can appear.
Licensed Service Status	
#	This shows how many licensed services there are.
Status	This is the current status of the license.
Name	This identifies the licensed service.

Table 19 Dashboard (continued)

LABEL	DESCRIPTION
Version	This is the version number of the content filtering signatures.
Expiration	If the service license is valid, this shows when it will expire. N/A displays if the service license does not have a limited period of validity.
Content Filter Statistics	This section displays the content filter statistics since the ZyWALL was last restarted.
Total Web Pages Inspected	This is the number of web pages the ZyWALL has checked to see whether they belong to the categories you selected in the content filter screen.
Blocked	This is the number of web pages that the ZyWALL blocked access.
Warned	This is the number of web pages for which the ZyWALL has displayed a warning message to the access requesters.
Passed	This is the number of web pages that the ZyWALL allowed access.
Security Threat (unsafe)	This is the number of requested web pages that belong to the unsafe categories you have selected in the content filter screen.
Managed Web Pages	This is the number of requested web pages that belong to the managed categories you have selected in the content filter screen.

8.2.1 The CPU Usage Screen

Use this screen to look at a chart of the ZyWALL's recent CPU usage. To access this screen, click **CPU Usage** in the dashboard.

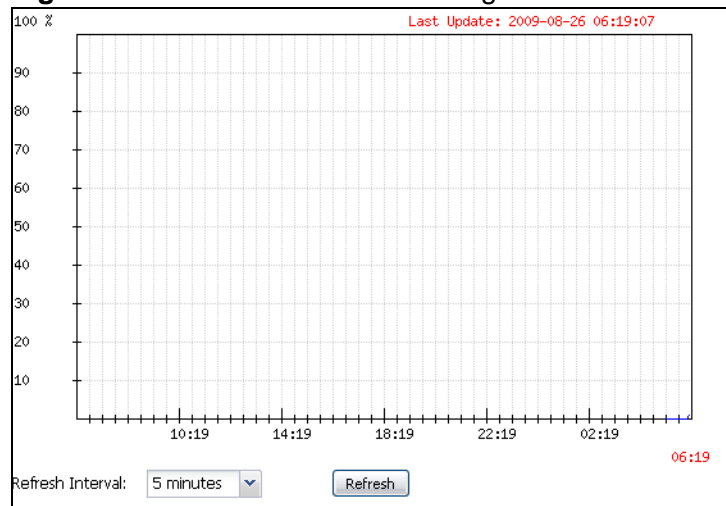
Figure 129 Dashboard > CPU Usage

The following table describes the labels in this screen.

Table 20 Dashboard > CPU Usage

LABEL	DESCRIPTION
	The y-axis represents the percentage of CPU usage.
	The x-axis shows the time period over which the CPU usage occurred
Refresh Interval	Enter how often you want this window to be automatically updated.
Refresh	Click this to update the information in the window right away.

8.2.2 The Memory Usage Screen

Use this screen to look at a chart of the ZyWALL's recent memory (RAM) usage. To access this screen, click **Memory Usage** in the dashboard.

Figure 130 Dashboard > Memory Usage

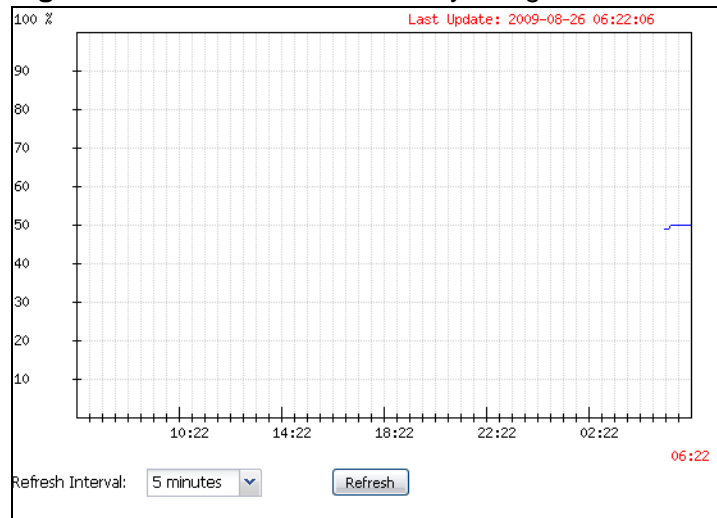

The following table describes the labels in this screen.

Table 21 Dashboard > Memory Usage

LABEL	DESCRIPTION
	The y-axis represents the percentage of RAM usage.
	The x-axis shows the time period over which the RAM usage occurred
Refresh Interval	Enter how often you want this window to be automatically updated.
Refresh	Click this to update the information in the window right away.

8.2.3 The Active Sessions Screen

Use this screen to look at a chart of the ZyWALL's recent traffic session usage. To access this screen, click **Session Usage** in the dashboard.

Figure 131 Dashboard > Session Usage

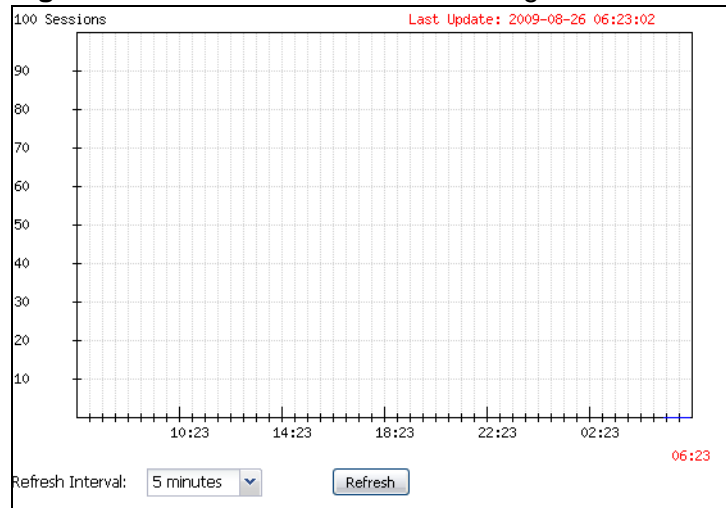

The following table describes the labels in this screen.

Table 22 Dashboard > Session Usage

LABEL	DESCRIPTION
Sessions	The y-axis represents the number of session.
	The x-axis shows the time period over which the session usage occurred
Refresh Interval	Enter how often you want this window to be automatically updated.
Refresh	Click this to update the information in the window right away.

8.2.4 The VPN Status Screen

Use this screen to look at the VPN tunnels that are currently established. To access this screen, click **VPN Status** in the dashboard.

Figure 132 Dashboard > VPN Status

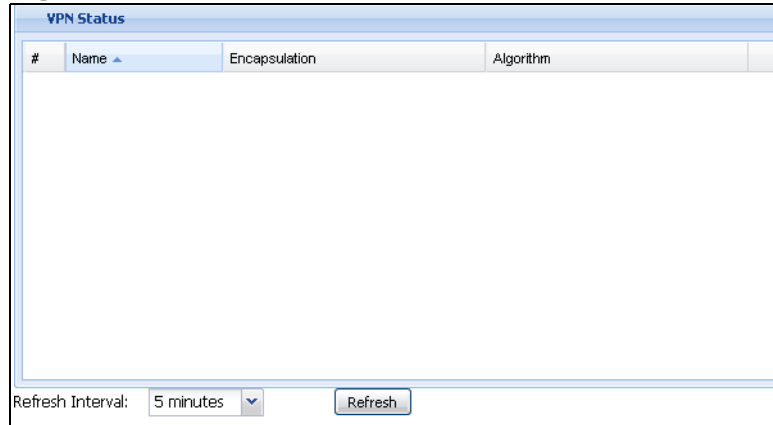

The following table describes the labels in this screen.

Table 23 Dashboard > VPN Status

LABEL	DESCRIPTION
#	This field is a sequential value, and it is not associated with a specific SA.
Name	This field displays the name of the IPsec SA.
Encapsulation	This field displays how the IPsec SA is encapsulated.
Algorithm	This field displays the encryption and authentication algorithms used in the SA.
Refresh Interval	Select how often you want this window to be updated automatically.
Refresh	Click this to update the information in the window right away.

8.2.5 The DHCP Table Screen

Use this screen to look at the IP addresses currently assigned to DHCP clients and the IP addresses reserved for specific MAC addresses. To access this screen, click the icon beside **DHCP Table** in the dashboard.

Figure 133 Dashboard > DHCP Table

#	Interface	IP Address	Host Name	MAC Address	Description	Reserve
1	Ian1	192.168.1.33	"twpc11746-01"	00:0f:fe:1e:4a:e0		<input type="checkbox"/>

The following table describes the labels in this screen.

Table 24 Dashboard > DHCP Table

LABEL	DESCRIPTION
#	This field is a sequential value, and it is not associated with a specific entry.
Interface	This field identifies the interface that assigned an IP address to a DHCP client.
IP Address	This field displays the IP address currently assigned to a DHCP client or reserved for a specific MAC address. Click the column's heading cell to sort the table entries by IP address. Click the heading cell again to reverse the sort order.
Host Name	This field displays the name used to identify this device on the network (the computer name). The ZyWALL learns these from the DHCP client requests. "None" shows here for a static DHCP entry.
MAC Address	This field displays the MAC address to which the IP address is currently assigned or for which the IP address is reserved. Click the column's heading cell to sort the table entries by MAC address. Click the heading cell again to reverse the sort order.
Description	For a static DHCP entry, the host name or the description you configured shows here. This field is blank for dynamic DHCP entries.
Reserve	<p>If this field is selected, this entry is a static DHCP entry. The IP address is reserved for the MAC address.</p> <p>If this field is clear, this entry is a dynamic DHCP entry. The IP address is assigned to a DHCP client.</p> <p>To create a static DHCP entry using an existing dynamic DHCP entry, select this field, and then click Apply.</p> <p>To remove a static DHCP entry, clear this field, and then click Apply.</p>

8.2.6 The Number of Login Users Screen

Use this screen to look at a list of the users currently logged into the ZyWALL. To access this screen, click the dashboard's **Number of Login Users** icon.

Figure 134 Dashboard > Number of Login Users

Number of Login Users					
#	User ID ▲	Reauth Lease T.	Type	IP Address	Force Logout
1	admin	unlimited / unlimited	http/https	192.168.1.33	 Logout

The following table describes the labels in this screen.

Table 25 Dashboard > Number of Login Users

LABEL	DESCRIPTION
#	This field is a sequential value and is not associated with any entry.
User ID	This field displays the user name of each user who is currently logged in to the ZyWALL.
Reauth Lease T.	This field displays the amount of reauthentication time remaining and the amount of lease time remaining for each user. See Chapter 33 on page 539 .
Type	This field displays the way the user logged in to the ZyWALL.
IP address	This field displays the IP address of the computer used to log in to the ZyWALL.
Force Logout	Click this icon to end a user's session.

Monitor

9.1 Overview

Use the **Monitor** screens to check status and statistics information.

9.1.1 What You Can Do in this Chapter

Use the **Monitor** screens for the following.

- Use the **System Status > Port Statistics** screen (see [Section 9.2 on page 178](#)) to look at packet statistics for each physical port.
- Use the **System Status > Port Statistics > Graph View** screen (see [Section 9.2 on page 178](#)) to look at a line graph of packet statistics for each physical port.
- Use the **System Status > Interface Status** screen ([Section 9.3 on page 181](#)) to see all of the ZyWALL's interfaces and their packet statistics.
- Use the **System Status > Traffic Statistics** screen (see [Section 9.4 on page 183](#)) to start or stop data collection and view statistics.
- Use the **System Status > Session Monitor** screen (see [Section 9.5 on page 186](#)) to view sessions by user or service.
- Use the **System Status > DDNS Status** screen (see [Section 9.6 on page 189](#)) to view the status of the ZyWALL's DDNS domain names.
- Use the **System Status > IP/MAC Binding** screen ([Section 9.7 on page 189](#)) to view a list of devices that have received an IP address from ZyWALL interfaces with IP/MAC binding enabled.
- Use the **System Status > Login Users** screen ([Section 9.8 on page 190](#)) to look at a list of the users currently logged into the ZyWALL.
- Use the **System Status > WLAN Status** screen ([Section 9.9 on page 191](#)) to view the connection status of the wireless clients connected to (or trying to connect to) a IEEE 802.11b/g card installed in the ZyWALL. This is available for USG 20W only.
- Use the **System Status > Cellular Status** screen ([Section 9.9 on page 191](#)) to check your 3G connection status.
- Use the **System Status > USB Storage** screen ([Section 9.11 on page 195](#)) to view information about a connected USB storage device.

- Use the **VPN Monitor > IPSec** screen ([Section 9.12 on page 196](#)) to display and manage active IPSec SAs.
- Use the **VPN Monitor > SSL** screen (see [Section 9.13 on page 198](#)) to list the users currently logged into the VPN SSL client portal. You can also log out individual users and delete related session information.
- Use the **Anti-X Statistics > Content Filter** screen ([Section 9.14 on page 200](#)) to start or stop data collection and view content filter statistics.
- Use the **Anti-X Statistics > Content Filter > Cache** screen ([Section 9.15 on page 202](#)) to view and configure your ZyWALL's URL caching.
- Use the **Anti-X Statistics > Anti-Spam** screen ([Section 9.16 on page 204](#)) to start or stop data collection and view spam statistics.
- Use the **Anti-X Statistics > Anti-Spam > Status** screen ([Section 9.17 on page 206](#)) to see how many mail sessions the ZyWALL is currently checking and DNSBL statistics.
- Use the **Log** ([Section 9.18 on page 207](#)) to view the ZyWALL's current log messages. You can change the way the log is displayed, you can e-mail the log, and you can also clear the log in this screen.

9.2 The Port Statistics Screen

Use this screen to look at packet statistics for each Gigabit Ethernet port. To access this screen, click **Monitor > System Status > Port Statistics**.

Figure 135 Monitor > System Status > Port Statistics

Port Statistics

General Settings

Poll Interval: (1-60 seconds)

Statistics Table

#	Port	Status	TxPkts	RxPkts	Collisions	Tx B/s	Rx B/s	Up Time
1	1	Down	0	0	0	0	0	00:00:00
2	2	100MFull	17441	28522	0	0	0	01:11:58
3	3	Down	0	0	0	0	0	00:00:00
4	4	100MFull	28072	22179	0	0	0	01:11:50
5	5	Down	0	0	0	0	0	00:00:00
6	6	Down	0	0	0	0	0	00:00:00

Page 1 of 1 | Show 50 items | Displaying 1 - 6 of 6

System Up Time: 01:12:37

The following table describes the labels in this screen.

Table 26 Monitor > System Status > Port Statistics

LABEL	DESCRIPTION
Poll Interval	Enter how often you want this window to be updated automatically, and click Set Interval .
Set Interval	Click this to set the Poll Interval the screen uses.
Stop	Click this to stop the window from updating automatically. You can start it again by setting the Poll Interval and clicking Set Interval .
Switch to Graphic View	Click this to display the port statistics as a line graph.
#	This field displays the port's number in the list.
Port	This field displays the physical port number.
Status	This field displays the current status of the physical port. Down - The physical port is not connected. Speed / Duplex - The physical port is connected. This field displays the port speed and duplex setting (Full or Half).
TxPkts	This field displays the number of packets transmitted from the ZyWALL on the physical port since it was last connected.
RxPkts	This field displays the number of packets received by the ZyWALL on the physical port since it was last connected.
Collisions	This field displays the number of collisions on the physical port since it was last connected.
Tx B/s	This field displays the transmission speed, in bytes per second, on the physical port in the one-second interval before the screen updated.
Rx B/s	This field displays the reception speed, in bytes per second, on the physical port in the one-second interval before the screen updated.
Up Time	This field displays how long the physical port has been connected.
System Up Time	This field displays how long the ZyWALL has been running since it last restarted or was turned on.

9.2.1 The Port Statistics Graph Screen

Use this screen to look at a line graph of packet statistics for each physical port. To access this screen, click **Port Statistics** in the **Status** screen and then the **Switch to Graphic View Button**.

Figure 136 Monitor > System Status > Port Statistics > Switch to Graphic View

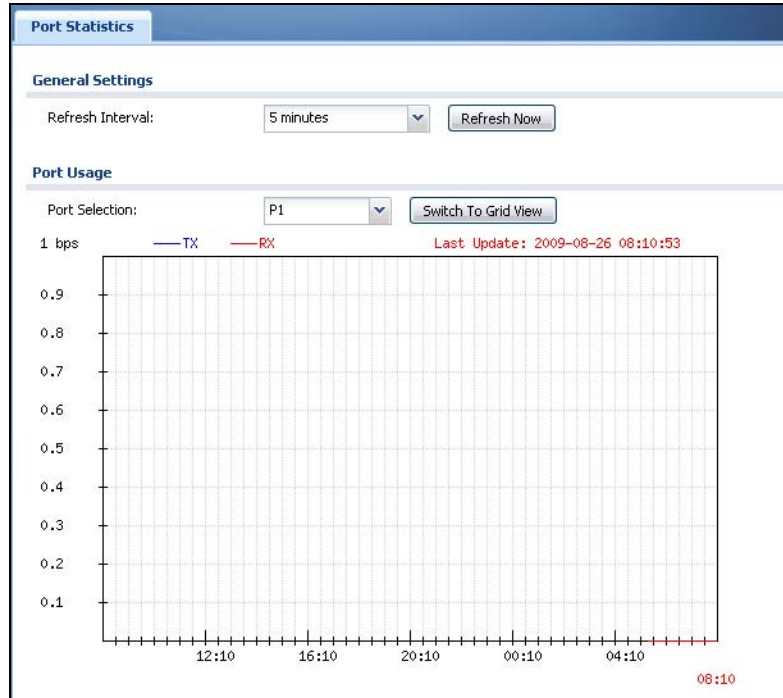

The following table describes the labels in this screen.

Table 27 Monitor > System Status > Port Statistics > Switch to Graphic View

LABEL	DESCRIPTION
Refresh Interval	Enter how often you want this window to be automatically updated.
Refresh Now	Click this to update the information in the window right away.
Port Selection	Select the number of the physical port for which you want to display graphics.
Switch to Grid View	Click this to display the port statistics as a table.
bps	The y-axis represents the speed of transmission or reception.
time	The x-axis shows the time period over which the transmission or reception occurred
TX	This line represents traffic transmitted from the ZyWALL on the physical port since it was last connected.
RX	This line represents the traffic received by the ZyWALL on the physical port since it was last connected.

Table 27 Monitor > System Status > Port Statistics > Switch to Graphic View

LABEL	DESCRIPTION
Last Update	This field displays the date and time the information in the window was last updated.
System Up Time	This field displays how long the ZyWALL has been running since it last restarted or was turned on.

9.3 Interface Status Screen

This screen lists all of the ZyWALL's interfaces and gives packet statistics for them. Click **Monitor > System Status > Interface Status** to access this screen.

Figure 137 Monitor > System Status > Interface Status

Interface Summary

Name	Port	Status	Zone	IP Addr/Netmask	IP Assignment	Services	Action
wan1	P1	Down	WAN	0.0.0.0 / 0.0.0.0	Static	n/a	n/a
wan1_ppp	P1	Connected	WAN	10.64.64.77 / 255.255.255.255	Dynamic	n/a	
wan2	P2	100M/Full	WAN	172.23.31.129 / 255.255.255.0	DHCP client	n/a	<input type="button" value="Renew"/>
wan2_ppp	P2	Inactive	WAN	0.0.0.0 / 0.0.0.0	Dynamic	n/a	n/a
lan1	P3, P4	Up	LAN1	192.168.1.1 / 255.255.255.0	Static	DHCP server	n/a
dmz	P5, P6	Down	DMZ	192.168.3.1 / 255.255.255.0	Static	DHCP server	n/a
lan2	n/a	Down	LAN2	192.168.2.1 / 255.255.255.0	Static	DHCP server	n/a
cellular1	n/a	No device	n/a	0.0.0.0 / 255.255.255.255	Dynamic	n/a	n/a
cellular2	n/a	No device	n/a	0.0.0.0 / 255.255.255.255	Dynamic	n/a	n/a

Interface Statistics

Name	Status	TxPkts	RxPkts	Tx B/s	Rx B/s
wan1	100M/Full	7236	8281	0	49
wan1_ppp	Connected (00:07:11)	195	151	0	0
wan2	100M/Full	17731	29233	0	96
wan2_ppp	Inactive			0	0
lan1	Up	28604	22718	0	224
dmz	Down	0	0	0	0
lan2	Down	0	0	0	0

Each field is described in the following table.

Table 28 Monitor > System Status > Interface Status

LABEL	DESCRIPTION
Interface Status	If an Ethernet interface does not have any physical ports associated with it, its entry is displayed in light gray text.
Expand/Close	Click this button to show or hide statistics for all the virtual interfaces on top of the Ethernet interfaces.
Name	This field displays the name of each interface. If there is a Expand icon (plus-sign) next to the name, click this to look at the status of virtual interfaces on top of this interface.

Table 28 Monitor > System Status > Interface Status (continued)

LABEL	DESCRIPTION
Port	This field displays the physical port number.
Status	<p>This field displays the current status of each interface. The possible values depend on what type of interface it is.</p> <p>For Ethernet interfaces:</p> <p>Inactive - The Ethernet interface is disabled.</p> <p>Down - The Ethernet interface does not have any physical ports associated with it or the Ethernet interface is enabled but not connected.</p> <p>Speed / Duplex - The Ethernet interface is enabled and connected. This field displays the port speed and duplex setting (Full or Half).</p> <p>For cellular (3G) interfaces, see Section 9.11 on page 195 for the status that can appear.</p> <p>For virtual interfaces, this field always displays Up. If the virtual interface is disabled, it does not appear in the list.</p> <p>For VLAN and bridge interfaces, this field always displays Up. If the VLAN or bridge interface is disabled, it does not appear in the list.</p> <p>For PPP interfaces:</p> <p>Connected - The PPP interface is connected.</p> <p>Disconnected - The PPP interface is not connected.</p> <p>If the PPP interface is disabled, it does not appear in the list.</p> <p>For WLAN interfaces:</p> <p>Up - The WLAN interface is enabled.</p> <p>Down - The WLAN interface is disabled.</p>
Zone	This field displays the zone to which the interface is assigned.
IP Addr/ Netmask	<p>This field displays the current IP address and subnet mask assigned to the interface. If the IP address and subnet mask are 0.0.0.0, the interface is disabled or did not receive an IP address and subnet mask via DHCP.</p> <p>If this interface is a member of an active virtual router, this field displays the IP address it is currently using. This is either the static IP address of the interface (if it is the master) or the management IP address (if it is a backup).</p>
IP Assignment	<p>This field displays how the interface gets its IP address.</p> <p>Static - This interface has a static IP address.</p> <p>DHCP Client - This interface gets its IP address from a DHCP server.</p>
Services	<p>This field lists which services the interface provides to the network. Examples include DHCP relay, DHCP server, DDNS, RIP, and OSPF. This field displays n/a if the interface does not provide any services to the network.</p>

Table 28 Monitor > System Status > Interface Status (continued)

LABEL	DESCRIPTION
Action	Use this field to get or to update the IP address for the interface. Click Renew to send a new DHCP request to a DHCP server. Click Connect to try to connect a PPPoE/PPTP interface. If the interface cannot use one of these ways to get or to update its IP address, this field displays n/a .
Interface Statistics	This table provides packet statistics for each interface.
Refresh	Click this button to update the information in the screen.
Expand/Close	Click this button to show or hide statistics for all the virtual interfaces on top of the Ethernet interfaces.
Name	This field displays the name of each interface. If there is a Expand icon (plus-sign) next to the name, click this to look at the statistics for virtual interfaces on top of this interface.
Status	This field displays the current status of the interface. Down - The interface is not connected. Speed / Duplex - The interface is connected. This field displays the port speed and duplex setting (Full or Half). This field displays Connected and the accumulated connection time (hh:mm:ss) when the PPP interface is connected.
TxPkts	This field displays the number of packets transmitted from the ZyWALL on the interface since it was last connected.
RxPkts	This field displays the number of packets received by the ZyWALL on the interface since it was last connected.
Tx B/s	This field displays the transmission speed, in bytes per second, on the interface in the one-second interval before the screen updated.
Rx B/s	This field displays the reception speed, in bytes per second, on the interface in the one-second interval before the screen updated.

9.4 The Traffic Statistics Screen

Click **Monitor > System Status > Traffic Statistics** to display the **Traffic Statistics** screen. This screen provides basic information about the following for example:

- Most-visited Web sites and the number of times each one was visited. This count may not be accurate in some cases because the ZyWALL counts HTTP GET packets. Please see [Table 29 on page 184](#) for more information.
- Most-used protocols or service ports and the amount of traffic on each one
- LAN IP with heaviest traffic and how much traffic has been sent to and from each one

You use the **Traffic Statistics** screen to tell the ZyWALL when to start and when to stop collecting information for these reports. You cannot schedule data collection; you have to start and stop it manually in the **Traffic Statistics** screen.

Figure 138 Monitor > System Status > Traffic Statistics

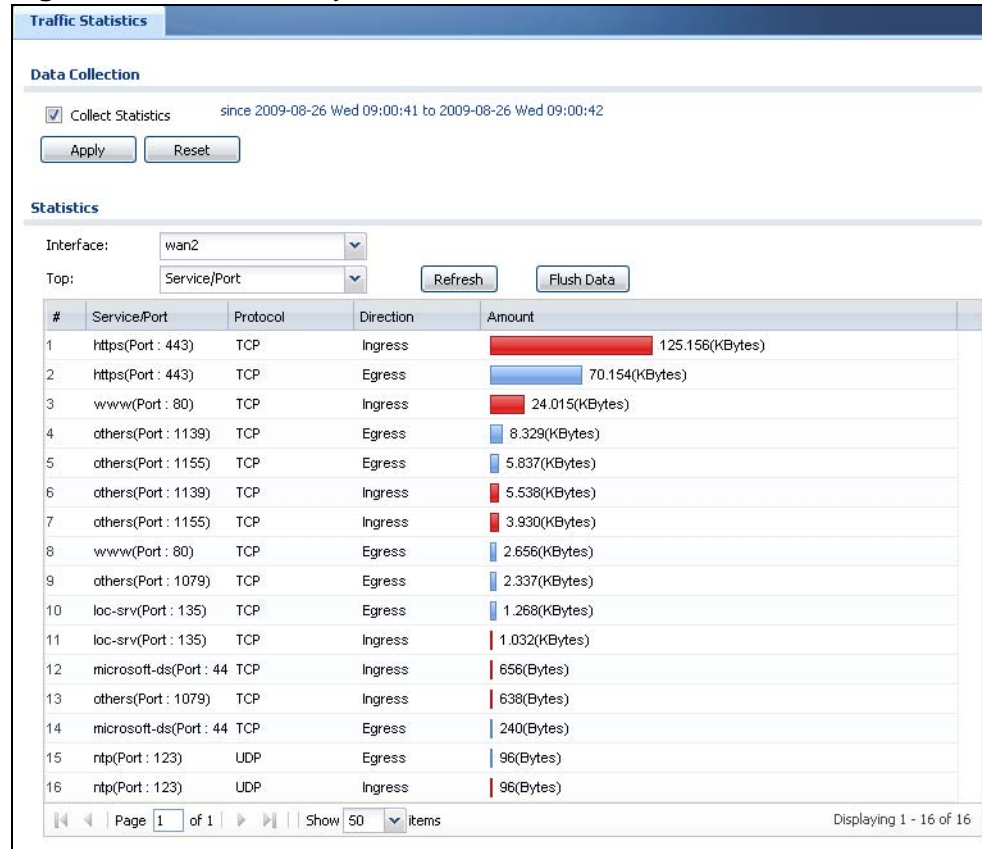

There is a limit on the number of records shown in the report. Please see [Table 30 on page 186](#) for more information. The following table describes the labels in this screen.

Table 29 Monitor > System Status > Traffic Statistics

LABEL	DESCRIPTION
Data Collection	
Collect Statistics	Select this to have the ZyWALL collect data for the report. If the ZyWALL has already been collecting data, the collection period displays to the right. The progress is not tracked here real-time, but you can click the Refresh button to update it.
Apply	Click Apply to save your changes back to the ZyWALL.
Reset	Click Reset to return the screen to its last-saved settings.
Statistics	
Interface	Select the interface from which to collect information. You can collect information from Ethernet, VLAN, bridge and PPPoE/PPTP interfaces.

Table 29 Monitor > System Status > Traffic Statistics (continued)

LABEL	DESCRIPTION
Traffic Type	<p>Select the type of report to display. Choices are:</p> <p>Host IP Address/User - displays the IP addresses or users with the most traffic and how much traffic has been sent to and from each one.</p> <p>Service/Port - displays the most-used protocols or service ports and the amount of traffic for each one.</p> <p>Web Site Hits - displays the most-visited Web sites and how many times each one has been visited.</p> <p>Each type of report has different information in the report (below).</p>
Refresh	Click this button to update the report display.
Flush Data	Click this button to discard all of the screen's statistics and update the report display.
	These fields are available when the Traffic Type is Host IP Address/User .
#	This field is the rank of each record. The IP addresses and users are sorted by the amount of traffic.
IP Address/ User	This field displays the IP address or user in this record. The maximum number of IP addresses or users in this report is indicated in Table 30 on page 186 .
Direction	<p>This field indicates whether the IP address or user is sending or receiving traffic.</p> <p>Ingress- traffic is coming from the IP address or user to the ZyWALL.</p> <p>Egress - traffic is going from the ZyWALL to the IP address or user.</p>
Amount	<p>This field displays how much traffic was sent or received from the indicated IP address or user. If the Direction is Ingress, a red bar is displayed; if the Direction is Egress, a blue bar is displayed. The unit of measure is bytes, Kbytes, Mbytes or Gbytes, depending on the amount of traffic for the particular IP address or user. The count starts over at zero if the number of bytes passes the byte count limit. See Table 30 on page 186.</p>
	These fields are available when the Traffic Type is Service/Port .
#	This field is the rank of each record. The protocols and service ports are sorted by the amount of traffic.
Service/Port	This field displays the service and port in this record. The maximum number of services and service ports in this report is indicated in Table 30 on page 186 .
Protocol	This field indicates what protocol the service was using.
Direction	<p>This field indicates whether the indicated protocol or service port is sending or receiving traffic.</p> <p>Ingress - traffic is coming into the router through the interface</p> <p>Egress - traffic is going out from the router through the interface</p>

Table 29 Monitor > System Status > Traffic Statistics (continued)

LABEL	DESCRIPTION
Amount	This field displays how much traffic was sent or received from the indicated service / port. If the Direction is Ingress , a red bar is displayed; if the Direction is Egress , a blue bar is displayed. The unit of measure is bytes, Kbytes, Mbytes, Gbytes, or Tbytes, depending on the amount of traffic for the particular protocol or service port. The count starts over at zero if the number of bytes passes the byte count limit. See Table 30 on page 186 .
	These fields are available when the Traffic Type is Web Site Hits .
#	This field is the rank of each record. The domain names are sorted by the number of hits.
Web Site	This field displays the domain names most often visited. The ZyWALL counts each page viewed on a Web site as another hit. The maximum number of domain names in this report is indicated in Table 30 on page 186 .
Hits	This field displays how many hits the Web site received. The ZyWALL counts hits by counting HTTP GET packets. Many Web sites have HTTP GET references to other Web sites, and the ZyWALL counts these as hits too. The count starts over at zero if the number of hits passes the hit count limit. See Table 30 on page 186 .

The following table displays the maximum number of records shown in the report, the byte count limit, and the hit count limit.

Table 30 Maximum Values for Reports

LABEL	DESCRIPTION
Maximum Number of Records	20
Byte Count Limit	2^{64} bytes; this is just less than 17 million terabytes.
Hit Count Limit	2^{64} hits; this is over 1.8×10^{19} hits.

9.5 The Session Monitor Screen

The **Session Monitor** screen displays information about active sessions for debugging or statistical analysis. It is not possible to manage sessions in this screen. The following information is displayed.

- User who started the session
- Protocol or service port used
- Source address
- Destination address
- Number of bytes received (so far)

- Number of bytes transmitted (so far)
- Duration (so far)

You can look at all the active sessions by user, service, source IP address, or destination IP address. You can also filter the information by user, protocol / service or service group, source address, and/or destination address and view it by user.

Click **Monitor > System Status > Session Monitor** to display the following screen.

Figure 139 Monitor > System Status > Session Monitor

The screenshot shows the 'Session Monitor' interface. At the top, there is a 'Session' section with a 'View:' dropdown set to 'all sessions' and a 'Refresh' button. Below this are input fields for 'User:', 'Service:' (set to 'any'), 'Source Address:', and 'Destination Address:', along with a 'Search' button. The main part of the screen is a table with the following data:

User	Service	Source	Destination	Rx	Tx	Duration
admin	HTTP	192.168.1.33:	72.14.203.102	48 Bytes	6144 Bytes	7826
admin	Any_UDP	192.168.1.33:	172.23.5.2:88	1024 Bytes	1024 Bytes	234
admin	Any_UDP	192.168.1.33:	172.23.5.2:88	1024 Bytes	1024 Bytes	212
admin	Any_UDP	192.168.1.33:	172.23.5.2:12	96 Bytes	96 Bytes	216
admin	NetBIOS_TCP2	192.168.1.33:	172.23.5.1:44	4096 Bytes	7168 Bytes	8934

At the bottom of the table, there are navigation controls: 'Page 1 of 1', 'Show 50 items', and 'Displaying 1 - 5 of 5'.

The following table describes the labels in this screen.

Table 31 Monitor > System Status > Session Monitor

LABEL	DESCRIPTION
View	Select how you want the information to be displayed. Choices are: sessions by users - display all active sessions grouped by user sessions by services - display all active sessions grouped by service or protocol sessions by source IP - display all active sessions grouped by source IP address sessions by destination IP - display all active sessions grouped by destination IP address all sessions - filter the active sessions by the User , Service , Source Address , and Destination Address , and display each session individually (sorted by user).
Refresh	Click this button to update the information on the screen. The screen also refreshes automatically when you open and close the screen.
	The User , Service , Source Address , and Destination Address fields display if you view all sessions. Select your desired filter criteria and click the Search button to filter the list of sessions.

Table 31 Monitor > System Status > Session Monitor (continued)

LABEL	DESCRIPTION
User	This field displays when View is set to all sessions . Type the user whose sessions you want to view. It is not possible to type part of the user name or use wildcards in this field; you must enter the whole user name.
Service	This field displays when View is set to all sessions . Select the service or service group whose sessions you want to view. The ZyWALL identifies the service by comparing the protocol and destination port of each packet to the protocol and port of each services that is defined. (See Chapter 35 on page 561 for more information about services.)
Source	This field displays when View is set to all sessions . Type the source IP address whose sessions you want to view. You cannot include the source port.
Destination	This field displays when View is set to all sessions . Type the destination IP address whose sessions you want to view. You cannot include the destination port.
Search	This button displays when View is set to all sessions . Click this button to update the information on the screen using the filter criteria in the User, Service, Source Address, and Destination Address fields.
Active Sessions	This is the total number of active sessions that matched the search criteria.
Show	Select the number of active sessions displayed on each page. You can use the arrow keys on the right to change pages.
User	This field displays the user in each active session. If you are looking at the sessions by users (or all sessions) report, click + or - to display or hide details about a user's sessions.
Service	This field displays the protocol used in each active session. If you are looking at the sessions by services report, click + or - to display or hide details about a protocol's sessions.
Source	This field displays the source IP address and port in each active session. If you are looking at the sessions by source IP report, click + or - to display or hide details about a source IP address's sessions.
Destination	This field displays the destination IP address and port in each active session. If you are looking at the sessions by destination IP report, click + or - to display or hide details about a destination IP address's sessions.
Rx	This field displays the amount of information received by the source in the active session.
Tx	This field displays the amount of information transmitted by the source in the active session.
Duration	This field displays the length of the active session in seconds.

9.6 The DDNS Status Screen

The **DDNS Status** screen shows the status of the ZyWALL's DDNS domain names. Click **Monitor > System Status > DDNS Status** to open the following screen.

Figure 140 Monitor > System Status > DDNS Status

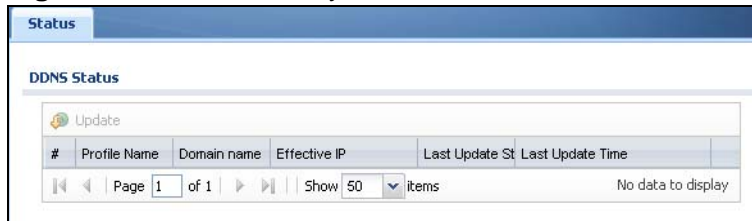

The following table describes the labels in this screen.

Table 32 Monitor > System Status > DDNS Status

LABEL	DESCRIPTION
Update	Click this to have the ZyWALL update the profile to the DDNS server. The ZyWALL attempts to resolve the IP address for the domain name.
Profile Name	This field displays the descriptive profile name for this entry.
Domain Name	This field displays each domain name the ZyWALL can route.
Effective IP	This is the (resolved) IP address of the domain name.
Last Update Status	This shows whether the last attempt to resolve the IP address for the domain name was successful or not. Updating means the ZyWALL is currently attempting to resolve the IP address for the domain name.
Last Update Time	This shows when the last attempt to resolve the IP address for the domain name occurred (in year-month-day hour:minute:second format).

9.7 IP/MAC Binding Monitor

Click **Monitor > System Status > IP/MAC Binding** to open the **IP/MAC Binding Monitor** screen. This screen lists the devices that have received an IP address from ZyWALL interfaces with IP/MAC binding enabled and have ever

established a session with the ZyWALL. Devices that have never established a session with the ZyWALL do not display in the list.

Figure 141 Monitor > System Status > IP/MAC Binding

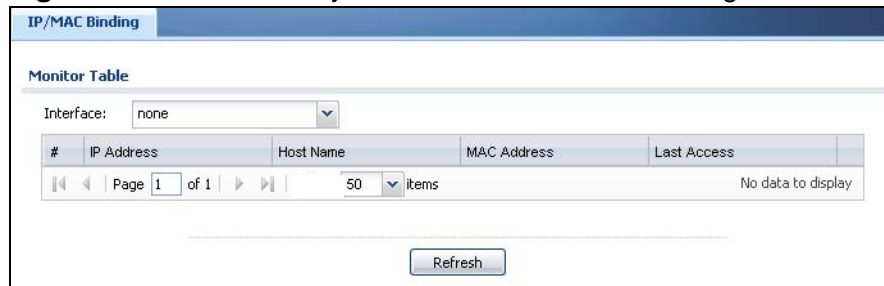

The following table describes the labels in this screen.

Table 33 Monitor > System Status > IP/MAC Binding

LABEL	DESCRIPTION
Interface	Select a ZyWALL interface that has IP/MAC binding enabled to show to which devices it has assigned an IP address.
#	This is the index number of an IP/MAC binding entry.
IP Address	This is the IP address that the ZyWALL assigned to a device.
Host Name	This field displays the name used to identify this device on the network (the computer name). The ZyWALL learns these from the DHCP client requests.
MAC Address	This field displays the MAC address to which the IP address is currently assigned.
Last Access	This is when the device last established a session with the ZyWALL through this interface.
Refresh	Click this button to update the information in the screen.

9.8 The Login Users Screen

Use this screen to look at a list of the users currently logged into the ZyWALL. To access this screen, click **Monitor > System Status > Login Users**.

Figure 142 Monitor > System Status > Login Users

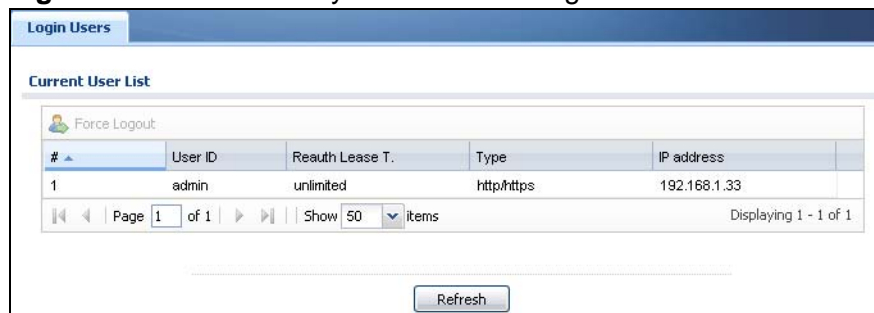

The following table describes the labels in this screen.

Table 34 Monitor > System Status > Login Users

LABEL	DESCRIPTION
#	This field is a sequential value and is not associated with any entry.
User ID	This field displays the user name of each user who is currently logged in to the ZyWALL.
Reauth Lease T.	This field displays the amount of reauthentication time remaining and the amount of lease time remaining for each user. See Chapter 33 on page 539 .
Type	This field displays the way the user logged in to the ZyWALL.
IP address	This field displays the IP address of the computer used to log in to the ZyWALL.
Force Logout	Click this icon to end a user's session.
Refresh	Click this button to update the information in the screen.

9.9 WLAN Status Screen

The WLAN Status screen displays the connection status of the wireless clients connected to (or trying to connect to) a IEEE 802.11b/g card installed in the ZyWALL.

To open the station monitor, click **Monitor > System Status > WLAN Status**. The screen appears as shown.

Figure 143 Monitor > System Status > WLAN Status



9.10 Cellular Status Screen

The following table describes the labels in this menu. **Cellular Status** screen

This screen displays your 3G connection status. click **Monitor > System Status > Cellular Status** to display this screen.

Figure 144 Monitor > System Status > Cellular Status

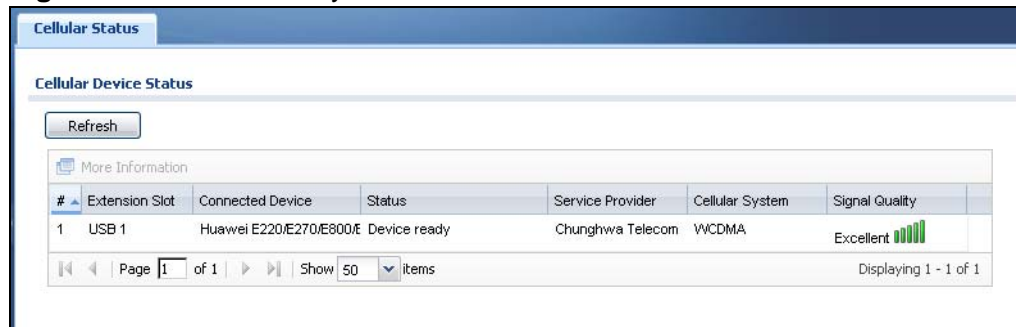

The following table describes the labels in this screen.

Table 35 Monitor > System Status > Cellular Status

LABEL	DESCRIPTION
Refresh	Click this button to update the information in the screen.
More Information	Click this to display more information on your 3G, such as the signal strength, IMEA/ESN and IMSI. This is only available when the 3G device attached and activated on your ZyWALL. Refer to Section 9.10.1 on page 194 .
#	This field is a sequential value, and it is not associated with any interface.
Extension Slot	This field displays where the entry's cellular card is located.
Connected Device	This field displays the model name of the cellular card.

Table 35 Monitor > System Status > Cellular Status (continued)

LABEL	DESCRIPTION
Status	<p>No device - no 3G device is connected to the ZyWALL.</p> <p>No Service - no 3G network is available in the area; you cannot connect to the Internet.</p> <p>Limited Service - returned by the service provider in cases where the SIM card is expired, the user failed to pay for the service and so on; you cannot connect to the Internet.</p> <p>Device detected - displays when you connect a 3G device.</p> <p>Device error - a 3G device is connected but there is an error.</p> <p>Probe device fail - the ZyWALL's test of the 3G device failed.</p> <p>Probe device ok - the ZyWALL's test of the 3G device succeeded.</p> <p>Init device fail - the ZyWALL was not able to initialize the 3G device.</p> <p>Init device ok - the ZyWALL initialized the 3G card.</p> <p>Check lock fail - the ZyWALL's check of whether or not the 3G device is locked failed.</p> <p>Device locked - the 3G device is locked.</p> <p>SIM error - there is a SIM card error on the 3G device.</p> <p>SIM locked-PUK - the PUK is locked on the 3G device's SIM card.</p> <p>SIM locked-PIN - the PIN is locked on the 3G device's SIM card.</p> <p>Unlock PUK fail - Your attempt to unlock a WCDMA 3G device's PUK failed because you entered an incorrect PUK.</p> <p>Unlock PIN fail - Your attempt to unlock a WCDMA 3G device's PIN failed because you entered an incorrect PIN.</p> <p>Unlock device fail - Your attempt to unlock a CDMA2000 3G device failed because you entered an incorrect device code.</p> <p>Device unlocked - You entered the correct device code and unlocked a CDMA2000 3G device.</p> <p>Get dev-info fail - The ZyWALL cannot get cellular device information.</p> <p>Get dev-info ok - The ZyWALL succeeded in retrieving 3G device information.</p> <p>Searching network - The 3G device is searching for a network.</p> <p>Get signal fail - The 3G device cannot get a signal from a network.</p> <p>Network found - The 3G device found a network.</p> <p>Apply config - The ZyWALL is applying your configuration to the 3G device.</p> <p>Inactive - The 3G interface is disabled.</p> <p>Active - The 3G interface is enabled.</p> <p>Incorrect device - The connected 3G device is not compatible with the ZyWALL.</p> <p>Correct device - The ZyWALL detected a compatible 3G device.</p> <p>Set band fail - Applying your band selection was not successful.</p> <p>Set band ok - The ZyWALL successfully applied your band selection.</p> <p>Set profile fail - Applying your ISP settings was not successful.</p> <p>Set profile ok - The ZyWALL successfully applied your ISP settings.</p> <p>PPP fail - The ZyWALL failed to create a PPP connection for the cellular interface.</p> <p>Need auth-password - You need to enter the password for the 3G card in the cellular edit screen.</p> <p>Device ready - The ZyWALL successfully applied all of your configuration and you can use the 3G connection.</p>
Service Provider	<p>This displays the name of your network service provider. This shows Limited Service if the service provider has stopped service to the 3G SIM card. For example if the bill has not been paid or the account has expired.</p>

Table 35 Monitor > System Status > Cellular Status (continued)

LABEL	DESCRIPTION
Cellular System	This field displays what type of cellular network the 3G connection is using. The network type varies depending on the 3G card you inserted and could be UMTS , UMTS/HSDPA , GPRS or EDGE when you insert a GSM 3G card, or 1xRTT , EVDO Rev.0 or EVDO Rev.A when you insert a CDMA 3G card.
Signal Quality	This displays the strength of the signal. The signal strength mainly depends on the antenna output power and the distance between your ZyWALL and the service provider's base station.

9.10.1 More Information

This screen displays more information on your 3G, such as the signal strength, IMEA/ESN and IMSI that helps identify your 3G device and SIM card. Click **Monitor > System Status > More Information** to display this screen.

Note: This screen is only available when the 3G device is attached to and activated on the ZyWALL.

Figure 145 Monitor > System Status > More Information

The following table describes the labels in this screen.

Table 36 Monitor > System Status > More Information

LABEL	DESCRIPTION
Extension Slot	This field displays where the entry's cellular card is located.
Service Provider	This displays the name of your network service provider. This shows Limited Service if the service provider has stopped service to the 3G SIM card. For example if the bill has not been paid or the account has expired.
Cellular System	This field displays what type of cellular network the 3G connection is using. The network type varies depending on the 3G card you inserted and could be UMTS , UMTS/HSDPA , GPRS or EDGE when you insert a GSM 3G card, or 1xRTT , EVDO Rev.0 or EVDO Rev.A when you insert a CDMA 3G card.
Signal Strength	This is the Signal Quality measured in dBm.
Signal Quality	This displays the strength of the signal. The signal strength mainly depends on the antenna output power and the distance between your ZyWALL and the service provider's base station.
Device Manufacturer	This shows the name of the company that produced the 3G device.
Device Model	This field displays the model name of the cellular card.
Device Firmware	This shows the software version of the 3G device.
Device IMEI/ ESN	IMEI (International Mobile Equipment Identity) is a 15-digit code in decimal format that identifies the 3G device. ESN (Electronic Serial Number) is an 8-digit code in hexadecimal format that identifies the 3G device.
SIM Card IMSI	IMSI (International Mobile Subscriber Identity) is a 15-digit code that identifies the SIM card.

9.11 USB Storage Screen

This screen displays information about a connected USB storage device. Click **Monitor > System Status > USB Storage** to display this screen.

Figure 146 Monitor > System Status > USB Storage

Storage Information	
Information	
Device description:	USB 2.0 USB Flash Dr
Usage:	3.2GB /3.8GB (83.9 %)
Filesystem:	FAT32
Speed:	USB 2.0 480Mbps
Status:	Ready Remove Now
Detail:	none

The following table describes the labels in this screen.

Table 37 Monitor > System Status > USB Storage

LABEL	DESCRIPTION
Device description	This is a basic description of the type of USB device.
Usage	This field displays how much of the USB storage device's capacity is currently being used out of its total capacity and what percentage that makes.
Filesystem	This field displays what file system the USB storage device is formatted with. This field displays Unknown if the file system of the USB storage device is not supported by the ZyWALL, such as NTFS.
Speed	This field displays the connection speed the USB storage device supports.
Status	<p>Ready - you can have the ZyWALL use the USB storage device.</p> <p>Click Remove Now to stop the ZyWALL from using the USB storage device so you can remove it.</p> <p>Unused - the connected USB storage device was manually unmounted by using the Remove Now button or for some reason the ZyWALL cannot mount it.</p> <p>Click Use It to have the ZyWALL mount a connected USB storage device. This button is grayed out if the file system is not supported (unknown) by the ZyWALL.</p> <p>none - no USB storage device is connected.</p>
Detail	<p>This field displays any other information the ZyWALL retrieves from the USB storage device.</p> <p>Deactivated - the use of a USB storage device is disabled (turned off) on the ZyWALL.</p> <p>OutofSpace - the available disk space is less than the disk space full threshold (see Section 43.2 on page 630 for how to configure this threshold).</p> <p>Mounting - the ZyWALL is mounting the USB storage device.</p> <p>Removing - the ZyWALL is unmounting the USB storage device.</p> <p>none - the USB device is operating normally or not connected.</p>

9.12 The IPSec Monitor Screen

You can use the **IPSec Monitor** screen to display and to manage active IPSec SAs. To access this screen, click **Monitor > VPN Monitor > IPSec**. The following

screen appears. Click a column's heading cell to sort the table entries by that column's criteria. Click the heading cell again to reverse the sort order.

Figure 147 Monitor > VPN Monitor > IPsec

The screenshot shows the 'IPsec' monitor interface. At the top, there are two input fields labeled 'Name:' and 'Policy:', followed by a 'Search' button. Below these is a 'Disconnect' button with a small icon. A table is displayed with the following columns: '#', 'Name', 'Encapsulation', 'Policy', 'Algorithm', 'Up Time', 'Timeout', 'Inbound(Bytes)', and 'Outbound(Bytes)'. The table is currently empty, with a message 'No data to display' at the bottom right. Below the table, there are navigation controls: 'Page 1 of 1', 'Show 50 items', and a 'Refresh' button.

Each field is described in the following table.

Table 38 Monitor > VPN Monitor > IPsec

LABEL	DESCRIPTION
Name	Enter the name of a IPsec SA here and click Search to find it (if it is associated). You can use a keyword or regular expression. Use up to 30 alphanumeric and _+-.(!\$*^:~ {}[]<>/ characters. See Section 9.12.1 on page 198 for more details.
Policy	Enter the IP address(es) or names of the local and remote policies for an IPsec SA and click Search to find it. You can use a keyword or regular expression. Use up to 30 alphanumeric and _+-.(!\$*^:~ {}[]<>/ characters. See Section 9.12.1 on page 198 for more details.
Search	Click this button to search for an IPsec SA that matches the information you specified above.
Disconnect	Select an IPsec SA and click this button to disconnect it.
Total Connection	This field displays the total number of associated IPsec SAs.
connection per page	Select how many entries you want to display on each page.
Page x of x	This is the number of the page of entries currently displayed and the total number of pages of entries. Type a page number to go to or use the arrows to navigate the pages of entries.
#	This field is a sequential value, and it is not associated with a specific SA.
Name	This field displays the name of the IPsec SA.
Encapsulation	This field displays how the IPsec SA is encapsulated.
Policy	This field displays the content of the local and remote policies for this IPsec SA. The IP addresses, not the address objects, are displayed.
Algorithm	This field displays the encryption and authentication algorithms used in the SA.
Up Time	This field displays how many seconds the IPsec SA has been active. This field displays N/A if the IPsec SA uses manual keys.

Table 38 Monitor > VPN Monitor > IPsec (continued)

LABEL	DESCRIPTION
Timeout	This field displays how many seconds remain in the SA life time, before the ZyWALL automatically disconnects the IPsec SA. This field displays N/A if the IPsec SA uses manual keys.
Inbound (Bytes)	This field displays the amount of traffic that has gone through the IPsec SA from the remote IPsec router to the ZyWALL since the IPsec SA was established.
Outbound (Bytes)	This field displays the amount of traffic that has gone through the IPsec SA from the ZyWALL to the remote IPsec router since the IPsec SA was established.
Refresh	Click Refresh to update the information in the display.

9.12.1 Regular Expressions in Searching IPsec SAs

A question mark (?) lets a single character in the VPN connection or policy name vary. For example, use "a?c" (without the quotation marks) to specify abc, acc and so on.

Wildcards (*) let multiple VPN connection or policy names match the pattern. For example, use "*abc" (without the quotation marks) to specify any VPN connection or policy name that ends with "abc". A VPN connection named "testabc" would match. There could be any number (of any type) of characters in front of the "abc" at the end and the VPN connection or policy name would still match. A VPN connection or policy name named "testacc" for example would not match.

A * in the middle of a VPN connection or policy name has the ZyWALL check the beginning and end and ignore the middle. For example, with "abc*123", any VPN connection or policy name starting with "abc" and ending in "123" matches, no matter how many characters are in between.

The whole VPN connection or policy name has to match if you do not use a question mark or asterisk.

9.13 The SSL Connection Monitor Screen

The ZyWALL keeps track of the users who are currently logged into the VPN SSL client portal. Click **Monitor > VPN Monitor > SSL** to display the user list.

Use this screen to do the following:

- View a list of active SSL VPN connections.
- Log out individual users and delete related session information.

Once a user logs out, the corresponding entry is removed from the **Connection Monitor** screen.

Figure 148 Monitor > VPN Monitor > SSL

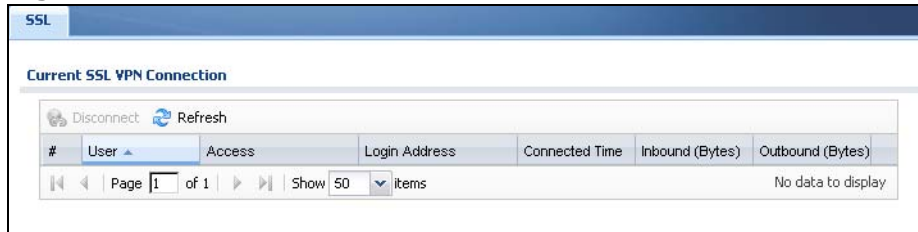

The following table describes the labels in this screen.

Table 39 Monitor > VPN Monitor > SSL

LABEL	DESCRIPTION
Disconnect	Select a connection and click this button to terminate the user's connection and delete corresponding session information from the ZyWALL.
#	This field displays the index number.
User	This field displays the account user name used to establish this SSL VPN connection.
Access	This field displays the name of the SSL VPN application the user is accessing.
Login Address	This field displays the IP address the user used to establish this SSL VPN connection.
Connected Time	This field displays the time this connection was established.
Inbound (Bytes)	This field displays the number of bytes received by the ZyWALL on this connection.
Outbound (Bytes)	This field displays the number of bytes transmitted by the ZyWALL on this connection.
Refresh	Click Refresh to update this screen.

9.14 The Content Filter Statistics Screen

Click **Monitor > Anti-X Statistics > Content Filter** to display the following screen. This screen displays content filter statistics.

Figure 149 Monitor > Anti-X Statistics > Content Filter

General Settings	
<input checked="" type="checkbox"/> Collect Statistics	since 2011-01-06 09:30:25 to 2011-01-07 11:41:47
<input type="button" value="Apply"/>	<input type="button" value="Reset"/>
<input type="button" value="Refresh"/>	<input type="button" value="Flush Data"/>
Web Request Statistics	
Total Web Pages Inspected:	87876
Blocked:	13
Warned:	3422
Passed:	84441
Category Hit Summary	
Security Threat (unsafe):	12
Managed Web Pages:	87864
Block Hit Summary	
Web Pages Warned by Category Service:	13
Web Pages Blocked by Custom Service:	0
Restricted Web Features:	0
Forbidden Web Sites:	0
URL Keywords:	0
Web Pages Blocked Without Policy:	0
Visit Report Server for Detail	

The following table describes the labels in this screen.

Table 40 Monitor > Anti-X Statistics > Content Filter

LABEL	DESCRIPTION
General Settings	
Collect Statistics	Select this check box to have the ZyWALL collect content filtering statistics. The collection starting time displays after you click Apply . All of the statistics in this screen are for the time period starting at the time displayed here. The format is year, month, day and hour, minute, second. All of the statistics are erased if you restart the ZyWALL or click Flush Data . Collecting starts over and a new collection start time displays.
Apply	Click Apply to save your changes back to the ZyWALL.
Reset	Click Reset to return the screen to its last-saved settings.
Refresh	Click this button to update the report display.

Table 40 Monitor > Anti-X Statistics > Content Filter (continued)

LABEL	DESCRIPTION
Flush Data	Click this button to discard all of the screen's statistics and update the report display.
Web Request Statistics	
Total Web Pages Inspected	This field displays the number of web pages that the ZyWALL's content filter feature has checked.
Blocked	This is the number of web pages that the ZyWALL blocked access.
Warned	This is the number of web pages for which the ZyWALL displayed a warning message to the access requesters.
Passed	This is the number of web pages to which the ZyWALL allowed access.
Category Hit Summary	
Security Threat (unsafe)	This is the number of requested web pages that the ZyWALL's content filtering service identified as posing a threat to users.
Managed Web Pages	This is the number of requested web pages that the ZyWALL's content filtering service identified as belonging to a category that was selected to be managed.
Block Hit Summary	
Web Pages Warned by Category Service	This is the number of web pages that matched an external database content filtering category selected in the ZyWALL and for which the ZyWALL displayed a warning before allowing users access.
Web Pages Blocked by Custom Service	This is the number of web pages to which the ZyWALL did not allow access due to the content filtering custom service configuration.
Restricted Web Features	This is the number of web pages to which the ZyWALL did not allow access due to the content filtering custom service's restricted web features configuration.
Forbidden Web Sites	This is the number of web pages to which the ZyWALL did not allow access because they matched the content filtering custom service's forbidden web sites list.
URL Keywords	This is the number of web pages to which the ZyWALL did not allow access because they contained one of the content filtering custom service's list of forbidden keywords.
Web Pages Blocked Without Policy	This is the number of web pages to which the ZyWALL did not allow access because they were not rated by the external database content filtering service.
Report Server	Click this link to go to http://www.myZyXEL.com where you can view content filtering reports after you have activated the category-based content filtering subscription service.

9.15 Content Filter Cache Screen

Click **Monitor > Anti-X Statistics > Content Filter > Cache** to display the **Content Filter Cache** screen. Use this screen to view and configure your ZyWALL's URL caching. You can also configure how long a categorized web site address remains in the cache as well as view those web site addresses to which access has been allowed or blocked based on the responses from the external content filtering server. The ZyWALL only queries the external content filtering database for sites not found in the cache.

You can remove individual entries from the cache. When you do this, the ZyWALL queries the external content filtering database the next time someone tries to access that web site. This allows you to check whether a web site's category has been changed.

Click a column's heading cell to sort the table entries by that column's criteria. Click the heading cell again to reverse the sort order.

Figure 150 Anti-X > Content Filter > Cache

The screenshot displays the 'Content Filter Cache' interface. At the top, there are 'Report' and 'Cache' tabs. Below the tabs, there are 'Refresh' and 'Flush' buttons. A 'Remove' button is located above the table. The table lists 17 entries with the following columns: #, Category, URL, and Remaining Time. The 'Remaining Time' column is sorted in descending order. Below the table, there are navigation controls: 'Page 1 of 1', 'Show 50 items', and 'Displaying 1 - 17 of 17'. At the bottom, there is a 'URL Cache Setup' section with a 'Maximum TTL' field set to 72 (1~720 hours). 'Apply' and 'Reset' buttons are located at the bottom right of the setup section.

#	Category	URL	Remaining Time
1	Computers/Internet	http://jobs.wired.com/feeds/jobroll?num_jobs=3&num_featured_jobs=1&subtype=wired&open_	4320
2	Computers/Internet	http://magazine.wired.com/ecom/status.jsp?ts=1255573776996&parent.referrer=http%3A%2F%3A	4320
3	Computers/Internet	http://a7.g.akamai.net/v7/2993/1d/viewpoint.download.akamai.com/2993/instream/v298/commo	4320
4	Job Search/Careers	http://syndication.jobthread.com/it/syndication/page.php?url_directory=&type=jobroll&s_domain	4320
5	News/Media	http://static.reddit.com/wired.js	4320
6	Search Engines/Portals	http://www.google-analytics.com/urchin.js	4320
7	Web Advertisements	http://pagead2.googleadsyndication.com/pagead/expansion_embed.js	4320
8	Web Advertisements	http://ec.atdmt.com/ks/GCASTMCD1WCD/WWorld_Brand/728x90_world.swf?ver=1&clickTag1=h	4320
9	Web Advertisements	http://ad.doubleclick.net/imp;v7;j;52395986;0-0;0;17209811;00;18633257/18651152/1;%%7Eaop	4320
10	Web Advertisements	http://content.dl-rms.com/rms/8481/nodetag.js	4320
11	Web Advertisements	http://ad.doubleclick.net/adj/wiredcom.dart/homepage;kw=home;sz=300x250;tile=4;ord=445794	4320
12	Web Advertisements	http://md.atdmt.com/DocumentDotWrite.js	4320
13	Web Advertisements	http://view.atdmt.com/AST/view/144303932/direct/01/1094473?click=http://ad.doubleclick.net/c	4320
14	Web Advertisements	http://ad.doubleclick.net/adj/wiredcom.dart/wired_issue;kw=wired;kw=null;kw=null;dcopt=ist;sz	4320
15	Web Advertisements	http://ad.doubleclick.net/adj/wiredcom.dart/homepage;kw=home;sz=970x418;tile=3;ord=445794	4320
16	Web Advertisements	http://ad.doubleclick.net/adj/wiredcom.dart/homepage;kw=home;sz=400x82;tile=2;ord=4457947	4320
17	Web Advertisements	http://ad.doubleclick.net/adj/wiredcom.dart/homepage;kw=home;dcopt=ist;sz=200x82;tile=1;ord	4320

URL Cache Setup

Maximum TTL: (1~720 hours)

Apply Reset

The following table describes the labels in this screen.

Table 41 Anti-X > Content Filter > Cache

LABEL	DESCRIPTION
URL Cache Entry	
Refresh	Click this button to reload the list of content filter cache entries.
Flush	Click this button to clear all web site addresses from the cache manually.
Remove	Select one or more URL entries and click Delete to remove them from the cache.
#	This is the index number of a categorized web site address record.
Category	<p>This field shows whether access to the web site's URL was blocked-or allowed.</p> <p>Click the column heading to sort the entries. Point the triangle up to display the blocked URLs before the URLs to which access was allowed. Point the triangle down to display the URLs to which access was allowed before the blocked URLs.</p>
URL	This is a web site's address that the ZyWALL previously checked with the external content filtering database.
Remaining Time (minutes)	This is the number of minutes left before the URL entry is discarded from the cache.
URL Cache Setup	
Maximum TTL	<p>Type the maximum time to live (TTL) (1 to 720 hours). This sets how long the ZyWALL is to keep an entry in the URL cache before discarding it.</p> <p>The external content filtering database frequently adds previously un-categorized web sites and sometimes changes a web site's category. Setting this limit higher will speed up the processing of web access requests but will also make it take longer for the ZyWALL to reflect changes in the external content filtering database.</p>
Apply	Click Apply to save your changes back to the ZyWALL.
Reset	Click Reset to return the screen to its last-saved settings.

9.16 The Anti-Spam Statistics Screen

Click **Monitor > Anti-X Statistics > Anti-Spam** to display the following screen. This screen displays spam statistics.

Figure 151 Monitor > Anti-X Statistics > Anti-Spam

The following table describes the labels in this screen.

Table 42 Monitor > Anti-X Statistics > Anti-Spam

LABEL	DESCRIPTION
Collect Statistics	Select this check box to have the ZyWALL collect anti-spam statistics. The collection starting time displays after you click Apply . All of the statistics in this screen are for the time period starting at the time displayed here. The format is year, month, day and hour, minute, second. All of the statistics are erased if you restart the ZyWALL or click Flush Data . Collecting starts over and a new collection start time displays.
Apply	Click Apply to save your changes back to the ZyWALL.
Reset	Click Reset to return the screen to its last-saved settings.
Refresh	Click this button to update the report display.
Flush Data	Click this button to discard all of the screen's statistics and update the report display.
Total Mails Scanned	This field displays the number of e-mails that the ZyWALL's anti-spam feature has checked.
Clear Mails	This is the number of e-mails that the ZyWALL has determined to not be spam.

Table 42 Monitor > Anti-X Statistics > Anti-Spam (continued)

LABEL	DESCRIPTION
Spam Mails	This is the number of e-mails that the ZyWALL has determined to be spam.
Spam Mails Detected by Black List	This is the number of e-mails that matched an entry in the ZyWALL's anti-spam black list.
Spam Mails Detected by DNSBL	The ZyWALL can check the sender and relay IP addresses in an e-mail's header against DNS (Domain Name Service)-based spam Black Lists (DNSBLs). This is the number of e-mails that had a sender or relay IP address in the header which matched one of the DNSBLs that the ZyWALL uses.
DSNBL Timeout	This is how many queries that were sent to the ZyWALL's configured list of DNSBL domains and did not receive a response in time.
Mail Sessions Forwarded	<p>This is how many e-mail sessions the ZyWALL allowed because they exceeded the maximum number of e-mail sessions that the anti-spam feature can check at a time.</p> <p>You can see the ZyWALL's threshold of concurrent e-mail sessions in the Anti-Spam > Status screen.</p> <p>Use the Anti-Spam > General screen to set whether the ZyWALL forwards or drops sessions that exceed this threshold.</p>
Mail Sessions Dropped	<p>This is how many e-mail sessions the ZyWALL dropped because they exceeded the maximum number of e-mail sessions that the anti-spam feature can check at a time.</p> <p>You can see the ZyWALL's threshold of concurrent e-mail sessions in the Anti-Spam > Status screen.</p> <p>Use the Anti-Spam > General screen to set whether the ZyWALL forwards or drops sessions that exceed this threshold.</p>
Top Sender By	<p>Use this field to list the top e-mail or IP addresses from which the ZyWALL has detected the most spam.</p> <p>Select Sender IP to list the source IP addresses from which the ZyWALL has detected the most spam.</p> <p>Select Sender Email Address to list the top e-mail addresses from which the ZyWALL has detected the most spam.</p>
#	This field displays the entry's rank in the list of the top entries.
Sender IP	This column displays when you display the entries by Sender IP . It shows the source IP address of spam e-mails that the ZyWALL has detected.
Sender Mail Address	This column displays when you display the entries by Sender Mail Address . This column displays the e-mail addresses from which the ZyWALL has detected the most spam.
Occurrence	This field displays how many spam e-mails the ZyWALL detected from the sender.

9.17 The Anti-Spam Status Screen

Click **Monitor > Anti-X Statistics > Anti-Spam > Status** to display the **Anti-Spam Status** screen.

Use the **Anti-Spam Status** screen to see how many e-mail sessions the anti-spam feature is scanning and statistics for the DNSBLs.

Figure 152 Monitor > Anti-X Statistics > Anti-Spam > Status

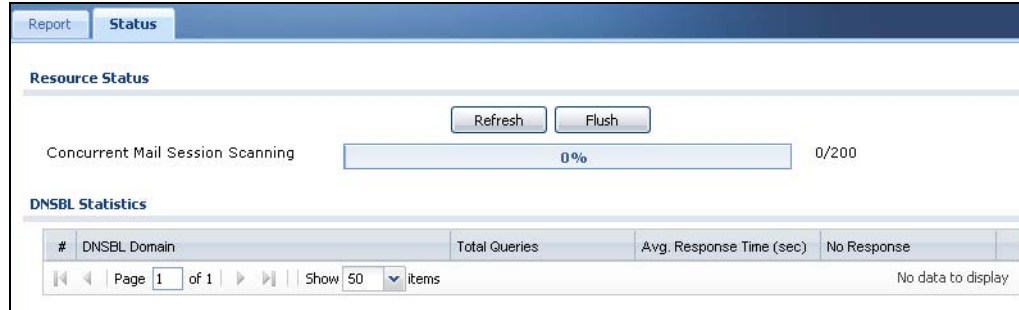

The following table describes the labels in this screen.

Table 43 Monitor > Anti-X Statistics > Anti-Spam > Status

LABEL	DESCRIPTION
Refresh	Click this button to update the information displayed on this screen.
Flush	Click this button to clear the DNSBL statistics. This also clears the concurrent mail session scanning bar's historical high.
Concurrent Mail Session Scanning	The darker shaded part of the bar shows how much of the ZyWALL's total spam checking capability is currently being used. The lighter shaded part of the bar and the pop-up show the historical high. The first number to the right of the bar is how many e-mail sessions the ZyWALL is presently checking for spam. The second number is the maximum number of e-mail sessions that the ZyWALL can check at once. An e-mail session is when an e-mail client and e-mail server (or two e-mail servers) connect through the ZyWALL.
DNSBL Statistics	These are the statistics for the DNSBL the ZyWALL uses. These statistics are for when the ZyWALL actually queries the DNSBL servers. Matches for DNSBL responses stored in the cache do not affect these statistics.
#	This is the entry's index number in the list.
DNSBL Domain	These are the DNSBLs the ZyWALL uses to check sender and relay IP addresses in e-mails.
Total Queries	This is the total number of DNS queries the ZyWALL has sent to this DNSBL.
Avg. Response Time (sec)	This is the average for how long it takes to receive a reply from this DNSBL.
No Response	This is how many DNS queries the ZyWALL sent to this DNSBL without receiving a reply.

9.18 Log Screen

Log messages are stored in two separate logs, one for regular log messages and one for debugging messages. In the regular log, you can look at all the log messages by selecting **All Logs**, or you can select a specific category of log messages (for example, firewall or user). You can also look at the debugging log by selecting **Debug Log**. All debugging messages have the same priority.

To access this screen, click **Monitor > Log**. The log is displayed in the following screen.

Note: When a log reaches the maximum number of log messages, new log messages automatically overwrite existing log messages, starting with the oldest existing log message first.

- For individual log descriptions, see [Appendix A on page 747](#).
- For the maximum number of log messages in the ZyWALL, see [Chapter 51 on page 741](#).

Events that generate an alert (as well as a log message) display in red. Regular logs display in black. Click a column's heading cell to sort the table entries by that column's criteria. Click the heading cell again to reverse the sort order.

Figure 153 Monitor > Log

The screenshot displays the ZyWALL Monitor > Log interface. It features a search and filter section at the top with the following fields:

- Display: All Logs
- Source Address: (empty)
- Source Interface: any
- Service: any
- Protocol: any
- Priority: any
- Destination Address: (empty)
- Destination Interface: any
- Keyword: (empty)

Below the filters is a 'Search' button and a toolbar with 'Email Log Now', 'Refresh', and 'Clear Log' options. The main log table is as follows:

#	Time	Priority	Category	Message	Source	Destination	Note
1	2010-01-18 01:20	notice	User	Administrator admin from http/https has	192.168.1.33	192.168.1.1	Account: ad
2	2010-01-18 00:34	info	System	NTP update has failed.			System
3	2010-01-18 00:33	info	DHCP	Sending ACK to 192.168.1.33 [count=2]			DHCP ACK
4	2010-01-18 00:32	info	DHCP	DHCP server assigned 192.168.1.33 to			DHCP ACK
5	2010-01-18 00:32	info	DHCP	Requested 192.168.1.33 from TWPC13			DHCP Reque
6	2010-01-18 00:32	info	DHCP	DHCP server offered 192.168.1.33 to T			DHCP Offer
7	2010-01-18 00:32	info	Policy Route	Interface wan2 alive, related policy rou			INTERFACE
8	2010-01-18 00:32	info		ZyWALL USG 50 is configured succes			
9	2010-01-18 00:32	info	Application P	Default port 1863 of service msn has b			CONFIG CH/
10	2010-01-18 00:32	info	Application P	Default port 554 of service rtsp has be			CONFIG CH/
11	2010-01-18 00:32	info	Application P	Default port 5060 of service sip has be			CONFIG CH/

At the bottom of the screen, there are navigation controls: Page 1 of 3, Show 50 items, and Displaying 1 - 50 of 102.

The following table describes the labels in this screen.

Table 44 Monitor > Log

LABEL	DESCRIPTION
Show Filter / Hide Filter	Click this button to show or hide the filter settings. If the filter settings are hidden, the Display , Email Log Now , Refresh , and Clear Log fields are available. If the filter settings are shown, the Display , Priority , Source Address , Destination Address , Service , Keyword , and Search fields are available.
Display	Select the category of log message(s) you want to view. You can also view All Logs at one time, or you can view the Debug Log .
Priority	This displays when you show the filter. Select the priority of log messages to display. The log displays the log messages with this priority or higher. Choices are: any , emerg , alert , crit , error , warn , notice , and info , from highest priority to lowest priority. This field is read-only if the Category is Debug Log .
Source Address	This displays when you show the filter. Type the source IP address of the incoming packet that generated the log message. Do not include the port in this filter.
Destination Address	This displays when you show the filter. Type the IP address of the destination of the incoming packet when the log message was generated. Do not include the port in this filter.
Source Interface	This displays when you show the filter. Select the source interface of the packet that generated the log message.
Destination Interface	This displays when you show the filter. Select the destination interface of the packet that generated the log message.
Service	This displays when you show the filter. Select the service whose log messages you would like to see. The Web Configurator uses the protocol and destination port number(s) of the service to select which log messages you see.
Keyword	This displays when you show the filter. Type a keyword to look for in the Message , Source , Destination and Note fields. If a match is found in any field, the log message is displayed. You can use up to 63 alphanumeric characters and the underscore, as well as punctuation marks () ' , ; ? ! + - * / = # \$ % @ ; the period, double quotes, and brackets are not allowed.
Protocol	This displays when you show the filter. Select a service protocol whose log messages you would like to see.
Search	This displays when you show the filter. Click this button to update the log using the current filter settings.
Email Log Now	Click this button to send log message(s) to the Active e-mail address(es) specified in the Send Log To field on the Log Settings page (see Section 44.3.2 on page 683).
Clear Log	Click this button to clear the whole log, regardless of what is currently displayed on the screen.
#	This field is a sequential value, and it is not associated with a specific log message.
Time	This field displays the time the log message was recorded.

Table 44 Monitor > Log (continued)

LABEL	DESCRIPTION
Priority	This field displays the priority of the log message. It has the same range of values as the Priority field above.
Category	This field displays the log that generated the log message. It is the same value used in the Display and (other) Category fields.
Message	This field displays the reason the log message was generated. The text "[count=x]", where <i>x</i> is a number, appears at the end of the Message field if log consolidation is turned on (see Log Consolidation in Table 212 on page 685) and multiple entries were aggregated to generate into this one.
Source	This field displays the source IP address and the port number in the event that generated the log message.
Destination	This field displays the destination IP address and the port number of the event that generated the log message.
Note	This field displays any additional information about the log message.

The Web Configurator saves the filter settings if you leave the **View Log** screen and return to it later.

Registration

10.1 Overview

Use the **Configuration > Licensing > Registration** screens to register your ZyWALL and manage its service subscriptions.

10.1.1 What You Can Do in this Chapter

- Use the **Registration** screen (see [Section 10.2 on page 212](#)) to register your ZyWALL with myZyXEL.com and activate a service, such as content filtering.
- Use the **Service** screen (see [Section 10.3 on page 214](#)) to display the status of your service registrations and upgrade licenses.

10.1.2 What you Need to Know

This section introduces the topics covered in this chapter.

myZyXEL.com

myZyXEL.com is ZyXEL's online services center where you can register your ZyWALL and manage subscription services available for the ZyWALL. To update signature files or use a subscription service, you have to register the ZyWALL and activate the corresponding service at myZyXEL.com (through the ZyWALL).

Note: You need to create a myZyXEL.com account before you can register your device and activate the services at myZyXEL.com.

You can directly create a myZyXEL.com account, register your ZyWALL and activate a service using the **Registration** screen. Alternatively, go to <http://www.myZyXEL.com> with the ZyWALL's serial number and LAN MAC address to register it. Refer to the web site's on-line help for details.

Note: To activate a service on a ZyWALL, you need to access myZyXEL.com via that ZyWALL.

Subscription Services Available on the ZyWALL

You can have the ZyWALL use and content filtering subscription services. You can also purchase and enter a license key to have the ZyWALL use more SSL VPN tunnels. See the respective User's Guide chapters for more information about these features.

10.2 The Registration Screen

Use this screen to register your ZyWALL with myZyXEL.com and activate a service, such as content filtering. Click **Configuration > Licensing > Registration** in the navigation panel to open the screen as shown next.

Figure 154 Configuration > Licensing > Registration

The screenshot displays the 'Registration' screen with two tabs: 'Registration' (selected) and 'Service'. The 'General Settings' section contains a red warning message: 'This device is not registered to myZyXEL.com. Please enter information below to register your device. If you don't have myZyXEL.com account, please select "new myZyXEL.com account" below. If you have a myZyXEL.com account, but you forget your User Name or Password, please go to www.myZyXEL.com for help.' Below this are two radio buttons: 'new myZyXEL.com account' (selected) and 'existing myZyXEL.com account'. The form includes fields for 'User Name', 'Password', 'Confirm Password', 'E-Mail Address', and 'Country' (a dropdown menu). A 'Check' button is next to the 'User Name' field with the text 'you can click to check if username exists'. The 'Seller Details' section has fields for 'Seller's Name', 'Seller's E-mail', 'Seller's Contact Number', and 'VAT Number'. A 'Privacy Policy' section follows, with a checkbox 'I accept the terms in the Privacy Policy' which is checked. The 'Trial Service Activation' section has a checkbox for 'Content Filter Category Service' which is unchecked. At the bottom, there is a logo for 'Content Control from Blue Coat' and an 'Apply' button.

The following table describes the labels in this screen.

Table 45 Configuration > Licensing > Registration

LABEL	DESCRIPTION
General Settings	If you select existing myZyXEL.com account , only the User Name and Password fields are available.
new myZyXEL.com account	If you haven't created an account at myZyXEL.com, select this option and configure the following fields to create an account and register your ZyWALL.
existing myZyXEL.com account	If you already have an account at myZyXEL.com, select this option and enter your user name and password in the fields below to register your ZyWALL.
UserName	Enter a user name for your myZyXEL.com account. The name should be from six to 20 alphanumeric characters (and the underscore). Spaces are not allowed.
Check	Click this button to check with the myZyXEL.com database to verify the user name you entered has not been used.
Password	Enter a password of between six and 20 alphanumeric characters (and the underscore). Spaces are not allowed.
Confirm Password	Enter the password again for confirmation.
E-Mail Address	Enter your e-mail address. You can use up to 80 alphanumeric characters (periods and the underscore are also allowed) without spaces.
Country	Select your country from the drop-down box list.
Seller Details	Use this section to enter your seller information.
Seller's Name	Enter your seller's name.
Seller's E-mail	Enter your seller's e-mail address.
Seller's Contact Number	Enter your seller's phone number.
VAT Number	Enter your seller's Value-Added Tax number, if you bought your ZyWALL from Europe.
I accept the terms in the Privacy Policy	If you accept the privacy policy statement shown above this field, select this check box.
Trial Service Activation	Select the check box to activate a trial service subscription. The trial period starts the day you activate the trial. After the trial expires, you can buy an iCard and enter the license key in the Registration Service screen to extend the service.
Content Filter Category Service	The content filter allows or blocks access to web sites. Subscribe to category-based content filtering to block access to categories of web sites based on content. Your ZyWALL accesses an external database that has millions of web sites categorized based on content. You can have the ZyWALL block, block and/or log access to web sites based on these categories.
Apply	Click Apply to save your changes back to the ZyWALL.

Note: If the ZyWALL is registered already, this screen is read-only and indicates whether trial services are activated (if any). You can still select the unchecked trial service(s) to activate it after registration. Use the **Service** screen to update your service subscription status.

Figure 155 Configuration > Licensing > Registration: Registered Device

10.3 The Service Screen

Use this screen to display the status of your service registrations and upgrade licenses. To activate or extend a standard service subscription, purchase an iCard and enter the iCard's PIN number (license key) in this screen. Click **Configuration > Licensing > Registration > Service** to open the screen as shown next.

Figure 156 Configuration > Licensing > Registration > Service

#	Service	Status	Registration Type	Expiration date	Count
1	Content Filter Category Service	Not Licensed			N/A
2	SSLVPN	Not Licensed			1

The following table describes the labels in this screen.

Table 46 Configuration > Licensing > Registration > Service

LABEL	DESCRIPTION
License Status	
#	This is the entry's position in the list.
Service	This lists the services that available on the ZyWALL.
Status	This field displays whether a service is activated (Licensed) or not (Not Licensed) or expired (Expired).
Registration Type	This field displays whether you applied for a trial application (Trial) or registered a service with your iCard's PIN number (Standard). This field is blank when a service is not activated.
Expiration date	This field displays the date your service expires.
Count	This field displays how many VPN tunnels you can use with your current license. This field does not apply to the other services.
License Upgrade	
License Key	Enter your iCard's PIN number and click Activation to activate or extend a standard service subscription. If a standard service subscription runs out, you need to buy a new iCard (specific to your ZyWALL) and enter the new PIN number to extend the service.
Service License Refresh	Click this button to renew service license information (such as the registration status and expiration day).

Interfaces

11.1 Interface Overview

Use the **Interface** screens to configure the ZyWALL's interfaces. You can also create interfaces on top of other interfaces.

- **Ports** are the physical ports to which you connect cables.
- **Interfaces** are used within the system operationally. You use them in configuring various features. An interface also describes a network that is directly connected to the ZyWALL. For example, You connect the LAN1 network to the LAN1 interface.
- **Zones** are groups of interfaces used to ease security policy configuration.

11.1.1 What You Can Do in this Chapter

- Use the **Port Role** screens ([Section 11.2 on page 220](#)) to create port groups and to assign physical ports and port groups to Ethernet interfaces.
- Use the **Ethernet** screens ([Section 11.3 on page 222](#)) to configure the Ethernet interfaces. Ethernet interfaces are the foundation for defining other interfaces and network policies. RIP and OSPF are also configured in these interfaces.
- Use the **PPP** screens ([Section 11.4 on page 233](#)) for PPPoE or PPTP Internet connections.
- Use the **Cellular** screens ([Section 11.5 on page 239](#)) to configure settings for interfaces for Internet connections through an installed 3G card.
- (For USG 20W only) Use the **WLAN** screens ([Section 11.6 on page 248](#)) to configure settings for interfaces on a wireless LAN card.
- Use the **VLAN** screens ([Section 11.8 on page 264](#)) to divide the physical network into multiple logical networks. VLAN interfaces receive and send tagged frames. The ZyWALL automatically adds or removes the tags as needed. Each VLAN can only be associated with one Ethernet interface.
- Use the **Bridge** screens ([Section 11.9 on page 274](#)) to combine two or more network segments into a single network.
- Use the **Virtual Interface** screen ([Section 11.9.3 on page 282](#)) to create virtual interfaces on top of Ethernet interfaces to tell the ZyWALL where to route packets. You can create virtual Ethernet interfaces, virtual VLAN interfaces, and virtual bridge interfaces.
- Use the **Trunk** screens ([Chapter 12 on page 289](#)) to configure load balancing.

11.1.2 What You Need to Know

Interface Characteristics

Interfaces generally have the following characteristics (although not all characteristics apply to each type of interface).

- An interface is a logical entity through which (layer-3) packets pass.
- An interface is bound to a physical port or another interface.
- Many interfaces can share the same physical port.
- An interface belongs to at most one zone.
- Many interfaces can belong to the same zone.
- Layer-3 virtualization (IP alias, for example) is a kind of interface.

Types of Interfaces

You can create several types of interfaces in the ZyWALL.

- Setting interfaces to the same port role forms a port group. Port groups create a hardware connection between physical ports at the layer-2 (data link, MAC address) level.
- **Ethernet interfaces** are the foundation for defining other interfaces and network policies. RIP and OSPF are also configured in these interfaces.
- **VLAN interfaces** receive and send tagged frames. The ZyWALL automatically adds or removes the tags as needed. Each VLAN can only be associated with one Ethernet interface.
- **Bridge interfaces** create a software connection between Ethernet or VLAN interfaces at the layer-2 (data link, MAC address) level. Unlike port groups, bridge interfaces can take advantage of some security features in the ZyWALL. You can also assign an IP address and subnet mask to the bridge.
- **PPP interfaces** support Point-to-Point Protocols (PPP). ISP accounts are required for PPPoE/PPTP interfaces.
- **Cellular interfaces** are for 3G WAN connections via a connected 3G device.
- **WLAN interfaces** are for wireless LAN (IEEE 802.11b/g) connections via an installed wireless LAN card (for USG 20W only).
- **Virtual interfaces** provide additional routing information in the ZyWALL. There are three types: **virtual Ethernet interfaces**, **virtual VLAN interfaces**, and **virtual bridge interfaces**.
- **Trunk interfaces** manage load balancing between interfaces.

Port groups and trunks have a lot of characteristics that are specific to each type of interface. See [Section 11.2 on page 220](#) and [Chapter 12 on page 289](#) for details. The other types of interfaces--Ethernet, PPP, cellular, VLAN, bridge, and

virtual--have a lot of similar characteristics. These characteristics are listed in the following table and discussed in more detail below.

Table 47 Ethernet, PPP, Cellular, VLAN, Bridge, and Virtual Interface Characteristics

CHARACTERISTICS	ETHERNET	ETHERNET	PPP	CELLULAR	VLAN	BRIDGE	VIRTUAL
Name*	wan1	lan1, lan2, dmz	pppx	cellularx	vlanx	brx	**
Configurable Zone	No	No	No	No	Yes	Yes	No
IP Address Assignment							
Static IP address	Yes	Yes	Yes	Yes	Yes	Yes	Yes
DHCP client	Yes	No	Yes	Yes	Yes	Yes	No
Routing metric	Yes	Yes	Yes	Yes	Yes	Yes	Yes
Interface Parameters							
Bandwidth restrictions	Yes	Yes	Yes	Yes	Yes	Yes	Yes
Packet size (MTU)	Yes	Yes	Yes	Yes	Yes	Yes	No
DHCP							
DHCP server	No	Yes	No	No	Yes	Yes	No
DHCP relay	No	Yes	No	No	Yes	Yes	No
Connectivity Check	Yes	No	Yes	No	Yes	Yes	No

* - The format of interface names other than the Ethernet and ppp interface names is strict. Each name consists of 2-4 letters (interface type), followed by a number (x). For most interfaces, x is limited by the maximum number of the type of interface. For VLAN interfaces, x is defined by the number you enter in the VLAN name field. For example, Ethernet interface names are wan1, lan1, lan2, dmz; VLAN interfaces are vlan0, vlan1, vlan2, ...; and so on.

** - The names of virtual interfaces are derived from the interfaces on which they are created. For example, virtual interfaces created on Ethernet interface wan1 are called wan1:1, wan1:2, and so on. Virtual interfaces created on VLAN interface vlan2 are called vlan2:1, vlan2:2, and so on. You cannot specify the number after the colon(:) in the Web Configurator; it is a sequential number. You can specify the number after the colon if you use the CLI to set up a virtual interface.

Relationships Between Interfaces

In the ZyWALL, interfaces are usually created on top of other interfaces. Only Ethernet interfaces are created directly on top of the physical ports or port groups. The relationships between interfaces are explained in the following table.

Table 48 Relationships Between Different Types of Interfaces

INTERFACE	REQUIRED PORT / INTERFACE
port group	physical port
Ethernet interface	physical port port group
VLAN interface	Ethernet interface

Table 48 Relationships Between Different Types of Interfaces (continued)

INTERFACE	REQUIRED PORT / INTERFACE
bridge interface	Ethernet interface* WLAN interface* (USG20W only) VLAN interface*
PPP interface	WAN1
virtual interface (virtual Ethernet interface) (virtual VLAN interface) (virtual bridge interface)	Ethernet interface* VLAN interface* bridge interface
trunk	Ethernet interface Cellular interface VLAN interface bridge interface PPP interface

* - You cannot set up a PPP interface, virtual Ethernet interface or virtual VLAN interface if the underlying interface is a member of a bridge. You also cannot add an Ethernet interface or VLAN interface to a bridge if the member interface has a virtual interface or PPP interface on top of it.

Finding Out More

- See [Section 6.2 on page 88](#) details on the differences between physical ports, interfaces, and zones in the ZyWALL.
- See [Section 6.5.3 on page 96](#) for related information about the **Interface** screens.
- See [Section 11.10 on page 284](#) for background information on interfaces.
- See [Section 7.1 on page 107](#) for an example of configuring Ethernet interfaces, port role, and zones.
- See [Section 7.2 on page 111](#) for an example of configuring a cellular (3G) interface.
- See [Chapter 12 on page 289](#) to configure load balancing using trunks.

11.2 Port Role

To access this screen, click **Configuration > Network > Interface > Port Role**. Use the **Port Role** screen to set the ZyWALL's flexible ports as part of the **lan1**, **lan2** or **dmz** interfaces. This creates a hardware connection between the physical

ports at the layer-2 (data link, MAC address) level. This provides wire-speed throughput but no security.

Note the following if you are configuring from a computer connected to a **lan1**, **lan2** or **dmz** port and change the port's role:

- 1 A port's IP address varies as its role changes, make sure your computer's IP address is in the same subnet as the ZyWALL's **lan1**, **lan2** or **dmz** IP address.
- 2 Use the appropriate **lan1**, **lan2** or **dmz** IP address to access the ZyWALL.

Figure 157 Configuration > Network > Interface > Port Role

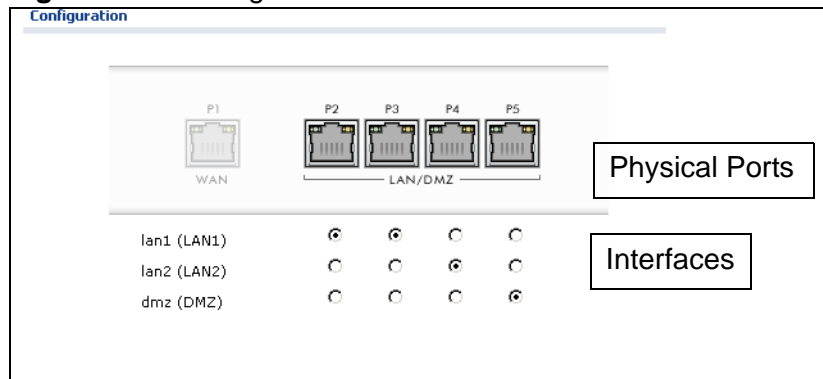

Each section in this screen is described below.

Table 49 Configuration > Network > Interface > Port Role

LABEL	DESCRIPTION
LAN1/DMZ P2~P5	These are physical Ethernet ports.
lan1 (LAN1) lan2 (LAN2) dmz (DMZ)	<p>These are Ethernet interfaces and the zone to which each belongs. Use the radio buttons to select for which interface (network) you want to use each physical port. For example, select a port's LAN1 radio button to use the port as part of the lan1 interface. The port will use the ZyWALL's lan1 IP address and MAC address.</p> <p>When you assign more than one physical port to a network, you create a port group. Port groups have the following characteristics:</p> <ul style="list-style-type: none"> • There is a layer-2 Ethernet switch between physical ports in the port group. This provides wire-speed throughput but no security. • It can increase the bandwidth between the port group and other interfaces. • The port group uses a single MAC address.
Apply	Click this button to save your changes and apply them to the ZyWALL.
Reset	Click this button to change the port groups to their current configuration (last-saved values).

11.3 Ethernet Summary Screen

This screen lists every Ethernet interface and virtual interface created on top of Ethernet interfaces. To access this screen, click **Configuration > Network > Interface > Ethernet**.

Unlike other types of interfaces, you cannot create new Ethernet interfaces nor can you delete any of them. If an Ethernet interface does not have any physical ports assigned to it (see [Section 11.2 on page 220](#)), the Ethernet interface is effectively removed from the ZyWALL, but you can still configure it.

Ethernet interfaces are similar to other types of interfaces in many ways. They have an IP address, subnet mask, and gateway used to make routing decisions. They restrict the amount of bandwidth and packet size. They can provide DHCP services, and they can verify the gateway is available.

Use Ethernet interfaces to control which physical ports exchange routing information with other routers and how much information is exchanged through each one. The more routing information is exchanged, the more efficient the routers should be. However, the routers also generate more network traffic, and some routing protocols require a significant amount of configuration and management. The ZyWALL supports two routing protocols, RIP and OSPF. See [Chapter 14 on page 313](#) for background information about these routing protocols.

Figure 158 Configuration > Network > Interface > Ethernet (USG 20W)

#	Status	Name	IP Address	Mask
1	🟡	wan1	DHCP -- 172.23.31.120	255.255.255.0
2	🟡	lan1	STATIC -- 192.168.1.1	255.255.255.0
3	🟡	lan2	STATIC -- 192.168.2.1	255.255.255.0
4	🟡	dmz	STATIC -- 192.168.3.1	255.255.255.0

Each field is described in the following table.

Table 50 Configuration > Network > Interface > Ethernet

LABEL	DESCRIPTION
Edit	Double-click an entry or select it and click Edit to open a screen where you can modify the entry's settings.
Remove	To remove a virtual interface, select it and click Remove . The ZyWALL confirms you want to remove it before doing so.
Activate	To turn on an interface, select it and click Activate .
Inactivate	To turn off an interface, select it and click Inactivate .
Create Virtual Interface	To open the screen where you can create a virtual Ethernet interface, select an Ethernet interface and click Create Virtual Interface .
Object References	Select an entry and click Object References to open a screen that shows which settings use the entry. See Section 11.3.2 on page 232 for an example.
#	This field is a sequential value, and it is not associated with any interface.
Status	This icon is lit when the entry is active and dimmed when the entry is inactive.
Name	This field displays the name of the interface.
IP Address	This field displays the current IP address of the interface. If the IP address is 0.0.0.0, the interface does not have an IP address yet. This screen also shows whether the IP address is a static IP address (STATIC) or dynamically assigned (DHCP). IP addresses are always static in virtual interfaces.
Mask	This field displays the interface's subnet mask in dot decimal notation.
Apply	Click Apply to save your changes back to the ZyWALL.
Reset	Click Reset to return the screen to its last-saved settings.

11.3.1 Ethernet Edit

The **Ethernet Edit** screen lets you configure IP address assignment, interface parameters, RIP settings, OSPF settings, DHCP settings, connectivity check, and MAC address settings. To access this screen, click an **Edit** icon in the **Ethernet Summary** screen. (See [Section 11.3 on page 222](#).)

The WAN interface's **Edit > Configuration** screen is shown here as an example.

Note: If you create IP address objects based on an interface's IP address, subnet, or gateway, the ZyWALL automatically updates every rule or setting that uses the object whenever the interface's IP address settings change. For example, if you change LAN1's IP address, the ZyWALL automatically updates the corresponding interface-based, LAN1 subnet address object.

With RIP, you can use Ethernet interfaces to do the following things.

- Enable and disable RIP in the underlying physical port or port group.
- Select which direction(s) routing information is exchanged - The ZyWALL can receive routing information, send routing information, or do both.
- Select which version of RIP to support in each direction - The ZyWALL supports RIP-1, RIP-2, and both versions.
- Select the broadcasting method used by RIP-2 packets - The ZyWALL can use subnet broadcasting or multicasting.

With OSPF, you can use Ethernet interfaces to do the following things.

- Enable and disable OSPF in the underlying physical port or port group.
- Select the area to which the interface belongs.
- Override the default link cost and authentication method for the selected area.
- Select in which direction(s) routing information is exchanged - The ZyWALL can receive routing information, send routing information, or do both.
- Set the priority used to identify the DR or BDR if one does not exist.

Figure 159 Configuration > Network > Interface > Ethernet > Edit (WAN)

Edit Ethernet

Hide Advanced Settings

General Settings

Enable Interface

Interface Properties

Interface Type: external

Interface Name: wan1

Port: P1

Zone: WAN

MAC Address: 00:00:AA:79:08:55

Description: (Optional)

IP Address Assignment

Get Automatically 0.0.0.0

Use Fixed IP Address

IP Address:

Subnet Mask:

Gateway: (Optional)

Metric: 0 (0-15)

Interface Parameters

Egress Bandwidth: 1048576 Kbps

Ingress Bandwidth: 1048576 Kbps

MTU: 1500 Bytes

Connectivity Check

Enable Connectivity Check

Check Method: icmp

Check Period: 30 (5-30 seconds)

Check Timeout: 5 (1-10 seconds)

Check Fail Tolerance: 5 (1-10)

Check Default Gateway 0.0.0.0

Check this address (Domain Name or IP Address)

RIP Setting

Enable RIP

Direction: BDir

Send Version: 2

Receive Version: 2

V2-Broadcast

OSPF Setting

Area: none

Priority: 1 (0-255)

Link Cost: 10 (1-65535)

Passive Interface

Authentication: None

MAC Address Setting

Use Default MAC Address 00:00:AA:79:08:55

Overwrite Default MAC Address 00:00:00:00:00:00 [Clone by host](#)

Related Setting

Configure [PPPoE/PPTP](#)

OK Cancel

Figure 160 Configuration > Network > Interface > Ethernet > Edit (DMZ)

The screenshot shows the 'Edit Ethernet' configuration window. It is divided into several sections:

- General Settings:** Includes a checkbox for 'Enable Interface' which is checked.
- Interface Properties:** Fields for Interface Type (internal), Interface Name (dmz), Port (P6), Zone (DMZ), MAC Address (00:00:AA:79:08:54), and an optional Description field.
- IP Address Assignment:** Fields for IP Address (192.168.3.1) and Subnet Mask (255.255.255.0).
- Interface Parameters:** Field for Egress Bandwidth (1048576 Kbps).
- DHCP Setting:** Includes a DHCP Server dropdown, IP Pool Start Address (192.168.3.33), Pool Size (200), and three DNS server dropdowns (ZyWALL, Custom Defined, Custom Defined). It also has fields for First and Second WINS Servers and a Lease time section with radio buttons for 'infinite' and '2 days 0 hours 0 minutes'.
- Static DHCP Table:** A table with columns for #, IP Address, MAC, and Description. The table is currently empty, showing 'Page 1 of 1' and 'No data to display'.

At the bottom of the window are buttons for 'Apply', 'Reset', 'OK', and 'Cancel'.

This screen's fields are described in the table below.

Table 51 Configuration > Network > Interface > Ethernet > Edit

LABEL	DESCRIPTION
Show Advance Settings / Hide Advance Settings	Click this button to display a greater or lesser number of configuration fields.
General Settings	
Enable Interface	Select this to enable this interface. Clear this to disable this interface.
Interface Properties	

Table 51 Configuration > Network > Interface > Ethernet > Edit (continued)

LABEL	DESCRIPTION
Interface Type	<p>This field is read-only.</p> <p>Internal is for connecting to a local network. Other corresponding configuration options: DHCP server and DHCP relay. The ZyWALL automatically adds default SNAT settings for traffic flowing from this interface to an external interface.</p> <p>External is for connecting to an external network (like the Internet). The ZyWALL automatically adds this interface to the default WAN trunk.</p> <p>For General, the rest of the screen's options do not automatically adjust and you must manually configure a policy route to add routing and SNAT settings for the interface.</p>
Interface Name	Specify a name for the interface. It can use alphanumeric characters, hyphens, and underscores, and it can be up to 11 characters long.
Port	This is the name of the Ethernet interface's physical port.
Zone	Select the zone to which this interface is to belong. You use zones to apply security settings such as firewall, remote management.
MAC Address	This field is read-only. This is the MAC address that the Ethernet interface uses.
Description	Enter a description of this interface. It is not used elsewhere. You can use alphanumeric and () + / : = ? ! * # @ \$ _ % - characters, and it can be up to 60 characters long.
IP Address Assignment	These IP address fields configure an IP address on the interface itself. If you change this IP address on the interface, you may also need to change a related address object for the network connected to the interface. For example, if you use this screen to change the IP address of your LAN interface, you should also change the corresponding LAN subnet address object.
Get Automatically	<p>This option appears when Interface Properties is External or General. Select this to make the interface a DHCP client and automatically get the IP address, subnet mask, and gateway address from a DHCP server.</p> <p>You should not select this if the interface is assigned to a VRRP group. See Chapter 39 on page 715.</p>
Use Fixed IP Address	This option appears when Interface Properties is External or General . Select this if you want to specify the IP address, subnet mask, and gateway manually.
IP Address	Enter the IP address for this interface.
Subnet Mask	Enter the subnet mask of this interface in dot decimal notation. The subnet mask indicates what part of the IP address is the same for all computers in the network.
Gateway	This option appears when Interface Properties is External or General . Enter the IP address of the gateway. The ZyWALL sends packets to the gateway when it does not know how to route the packet to its destination. The gateway should be on the same network as the interface.

Table 51 Configuration > Network > Interface > Ethernet > Edit (continued)

LABEL	DESCRIPTION
Metric	This option appears when Interface Properties is External or General . Enter the priority of the gateway (if any) on this interface. The ZyWALL decides which gateway to use based on this priority. The lower the number, the higher the priority. If two or more gateways have the same priority, the ZyWALL uses the one that was configured first.
Interface Parameters	
Egress Bandwidth	Enter the maximum amount of traffic, in kilobits per second, the ZyWALL can send through the interface to the network. Allowed values are 0 - 1048576.
Ingress Bandwidth	This is reserved for future use. Enter the maximum amount of traffic, in kilobits per second, the ZyWALL can receive from the network through the interface. Allowed values are 0 - 1048576.
MTU	Maximum Transmission Unit. Type the maximum size of each data packet, in bytes, that can move through this interface. If a larger packet arrives, the ZyWALL divides it into smaller fragments. Allowed values are 576 - 1500. Usually, this value is 1500.
Connectivity Check	These fields appear when Interface Properties is External or General . The interface can regularly check the connection to the gateway you specified to make sure it is still available. You specify how often the interface checks the connection, how long to wait for a response before the attempt is a failure, and how many consecutive failures are required before the ZyWALL stops routing to the gateway. The ZyWALL resumes routing to the gateway the first time the gateway passes the connectivity check.
Enable Connectivity Check	Select this to turn on the connection check.
Check Method	Select the method that the gateway allows. Select icmp to have the ZyWALL regularly ping the gateway you specify to make sure it is still available. Select tcp to have the ZyWALL regularly perform a TCP handshake with the gateway you specify to make sure it is still available.
Check Period	Enter the number of seconds between connection check attempts.
Check Timeout	Enter the number of seconds to wait for a response before the attempt is a failure.
Check Fail Tolerance	Enter the number of consecutive failures before the ZyWALL stops routing through the gateway.
Check Default Gateway	Select this to use the default gateway for the connectivity check.
Check this address	Select this to specify a domain name or IP address for the connectivity check. Enter that domain name or IP address in the field next to it.

Table 51 Configuration > Network > Interface > Ethernet > Edit (continued)

LABEL	DESCRIPTION
Check Port	This field only displays when you set the Check Method to tcp . Specify the port number to use for a TCP connectivity check.
DHCP Setting	These fields appear when Interface Properties is Internal or General .
DHCP	<p>Select what type of DHCP service the ZyWALL provides to the network. Choices are:</p> <p>None - the ZyWALL does not provide any DHCP services. There is already a DHCP server on the network.</p> <p>DHCP Relay - the ZyWALL routes DHCP requests to one or more DHCP servers you specify. The DHCP server(s) may be on another network.</p> <p>DHCP Server - the ZyWALL assigns IP addresses and provides subnet mask, gateway, and DNS server information to the network. The ZyWALL is the DHCP server for the network.</p>
	These fields appear if the ZyWALL is a DHCP Relay .
Relay Server 1	Enter the IP address of a DHCP server for the network.
Relay Server 2	This field is optional. Enter the IP address of another DHCP server for the network.
	These fields appear if the ZyWALL is a DHCP Server .
IP Pool Start Address	<p>Enter the IP address from which the ZyWALL begins allocating IP addresses. If you want to assign a static IP address to a specific computer, use the Static DHCP Table.</p> <p>If this field is blank, the Pool Size must also be blank. In this case, the ZyWALL can assign every IP address allowed by the interface's IP address and subnet mask, except for the first address (network address), last address (broadcast address) and the interface's IP address.</p>
Pool Size	<p>Enter the number of IP addresses to allocate. This number must be at least one and is limited by the interface's Subnet Mask. For example, if the Subnet Mask is 255.255.255.0 and IP Pool Start Address is 10.10.10.10, the ZyWALL can allocate 10.10.10.10 to 10.10.10.254, or 245 IP addresses.</p> <p>If this field is blank, the IP Pool Start Address must also be blank. In this case, the ZyWALL can assign every IP address allowed by the interface's IP address and subnet mask, except for the first address (network address), last address (broadcast address) and the interface's IP address.</p>
First DNS Server, Second DNS Server, Third DNS Server	<p>Specify the IP addresses up to three DNS servers for the DHCP clients to use. Use one of the following ways to specify these IP addresses.</p> <p>Custom Defined - enter a static IP address.</p> <p>From ISP - select the DNS server that another interface received from its DHCP server.</p> <p>ZyWALL - the DHCP clients use the IP address of this interface and the ZyWALL works as a DNS relay.</p>

Table 51 Configuration > Network > Interface > Ethernet > Edit (continued)

LABEL	DESCRIPTION
First WINS Server, Second WINS Server	Type the IP address of the WINS (Windows Internet Naming Service) server that you want to send to the DHCP clients. The WINS server keeps a mapping table of the computer names on your network and the IP addresses that they are currently using.
Lease time	Specify how long each computer can use the information (especially the IP address) before it has to request the information again. Choices are: infinite - select this if IP addresses never expire. days, hours, and minutes - select this to enter how long IP addresses are valid.
Enable IP/MAC Binding	Select this option to have this interface enforce links between specific IP addresses and specific MAC addresses. This stops anyone else from manually using a bound IP address on another device connected to this interface. Use this to make use only the intended users get to use specific IP addresses.
Enable Logs for IP/MAC Binding Violation	Select this option to have the ZyWALL generate a log if a device connected to this interface attempts to use an IP address that is bound to another device's MAC address.
Static DHCP Table	Configure a list of static IP addresses the ZyWALL assigns to computers connected to the interface. Otherwise, the ZyWALL assigns an IP address dynamically using the interface's IP Pool Start Address and Pool Size .
Add	Click this to create a new entry.
Edit	Select an entry and click this to be able to modify it.
Remove	Select an entry and click this to delete it.
#	This field is a sequential value, and it is not associated with a specific entry.
IP Address	Enter the IP address to assign to a device with this entry's MAC address.
MAC Address	Enter the MAC address to which to assign this entry's IP address.
Description	Enter a description to help identify this static DHCP entry. You can use alphanumeric and () + / : = ? ! * # @ \$ _ % - characters, and it can be up to 60 characters long.
RIP Setting	See Section 14.2 on page 314 for more information about RIP.
Enable RIP	Select this to enable RIP in this interface.
Direction	This field is effective when RIP is enabled. Select the RIP direction from the drop-down list box. BiDir - This interface sends and receives routing information. In-Only - This interface receives routing information. Out-Only - This interface sends routing information.
Send Version	This field is effective when RIP is enabled. Select the RIP version(s) used for sending RIP packets. Choices are 1 , 2 , and 1 and 2 .
Receive Version	This field is effective when RIP is enabled. Select the RIP version(s) used for receiving RIP packets. Choices are 1 , 2 , and 1 and 2 .

Table 51 Configuration > Network > Interface > Ethernet > Edit (continued)

LABEL	DESCRIPTION
V2-Broadcast	This field is effective when RIP is enabled. Select this to send RIP-2 packets using subnet broadcasting; otherwise, the ZyWALL uses multicasting.
OSPF Setting	See Section 14.3 on page 315 for more information about OSPF.
Area	Select the area in which this interface belongs. Select None to disable OSPF in this interface.
Priority	Enter the priority (between 0 and 255) of this interface when the area is looking for a Designated Router (DR) or Backup Designated Router (BDR). The highest-priority interface identifies the DR, and the second-highest-priority interface identifies the BDR. Set the priority to zero if the interface can not be the DR or BDR.
Link Cost	Enter the cost (between 1 and 65,535) to route packets through this interface.
Passive Interface	Select this to stop forwarding OSPF routing information from the selected interface. As a result, this interface only receives routing information.
Authentication	Select an authentication method, or disable authentication. To exchange OSPF routing information with peer border routers, you must use the same authentication method that they use. Choices are: Same-as-Area - use the default authentication method in the area None - disable authentication Text - authenticate OSPF routing information using a plain-text password MD5 - authenticate OSPF routing information using MD5 encryption
Text Authentication Key	This field is available if the Authentication is Text . Type the password for text authentication. The key can consist of alphanumeric characters and the underscore, and it can be up to 16 characters long.
MD5 Authentication ID	This field is available if the Authentication is MD5 . Type the ID for MD5 authentication. The ID can be between 1 and 255.
MD5 Authentication Key	This field is available if the Authentication is MD5 . Type the password for MD5 authentication. The password can consist of alphanumeric characters and the underscore, and it can be up to 16 characters long.
MAC Address Setting	This section appears when Interface Properties is External or General . Have the interface use either the factory assigned default MAC address, a manually specified MAC address, or clone the MAC address of another device or computer.
Use Default MAC Address	Select this option to have the interface use the factory assigned default MAC address. By default, the ZyWALL uses the factory assigned MAC address to identify itself.

Table 51 Configuration > Network > Interface > Ethernet > Edit (continued)

LABEL	DESCRIPTION
Overwrite Default MAC Address	Select this option to have the interface use a different MAC address. Either enter the MAC address in the fields or click Clone by host and enter the IP address of the device or computer whose MAC you are cloning. Once it is successfully configured, the address will be copied to the configuration file. It will not change unless you change the setting or upload a different configuration file.
Related Setting	
Configure PPPoE/PPTP	Click PPPoE/PPTP if this interface's Internet connection uses PPPoE or PPTP.
OK	Click OK to save your changes back to the ZyWALL.
Cancel	Click Cancel to exit this screen without saving.

11.3.2 Object References

When a configuration screen includes an **Object References** icon, select a configuration object and click **Object References** to open the **Object References** screen. This screen displays which configuration settings reference the selected object. The fields shown vary with the type of object.

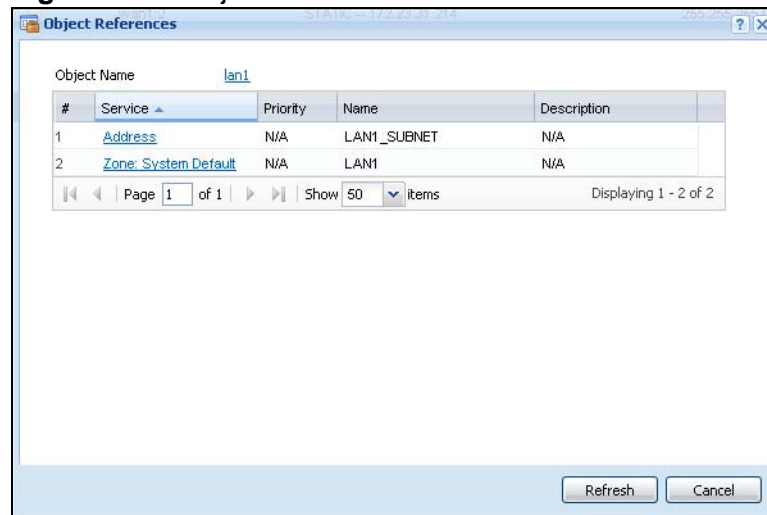
Figure 161 Object References

The following table describes labels that can appear in this screen.

Table 52 Object References

LABEL	DESCRIPTION
Object Name	This identifies the object for which the configuration settings that use it are displayed. Click the object's name to display the object's configuration screen in the main window.
#	This field is a sequential value, and it is not associated with any entry.

Table 52 Object References (continued)

LABEL	DESCRIPTION
Service	This is the type of setting that references the selected object. Click a service's name to display the service's configuration screen in the main window.
Priority	If it is applicable, this field lists the referencing configuration item's position in its list, otherwise N/A displays.
Name	This field identifies the configuration item that references the object.
Description	If the referencing configuration item has a description configured, it displays here.
Refresh	Click this to update the information in this screen.
Cancel	Click Cancel to close the screen.

11.4 PPP Interfaces

Use PPPoE/PPTP interfaces to connect to your ISP. This way, you do not have to install or manage PPPoE/PPTP software on each computer in the network.

Figure 162 Example: PPPoE/PPTP Interfaces

PPPoE/PPTP interfaces are similar to other interfaces in some ways. They have an IP address, subnet mask, and gateway used to make routing decisions; they restrict bandwidth and packet size; and they can verify the gateway is available. There are two main differences between PPPoE/PPTP interfaces and other interfaces.

- You must also configure an ISP account object for the PPPoE/PPTP interface to use.

Each ISP account specifies the protocol (PPPoE or PPTP), as well as your ISP account information. If you change ISPs later, you only have to create a new ISP account, not a new PPPoE/PPTP interface. You should not have to change any network policies.

- You do not set up the subnet mask or gateway.

PPPoE/PPTP interfaces are interfaces between the ZyWALL and only one computer. Therefore, the subnet mask is always 255.255.255.255. In addition, the ZyWALL always treats the ISP as a gateway.

At the time of writing, it is possible to set up the IP address of the gateway (ISP) using CLI commands but not in the Web Configurator.

11.4.1 PPP Interface Summary

This screen lists every PPPoE/PPTP interface. To access this screen, click **Configuration > Network > Interface > PPP**.

Figure 163 Configuration > Network > Interface > PPP

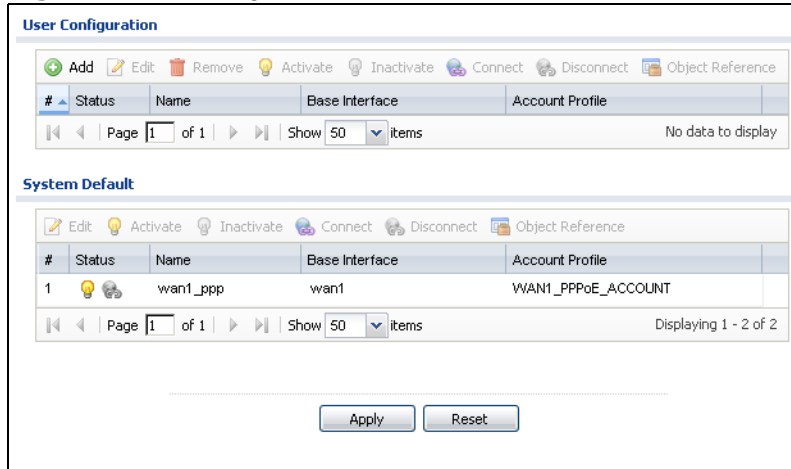

Each field is described in the table below.

Table 53 Configuration > Network > Interface > PPP

LABEL	DESCRIPTION
User Configuration / System Default	The ZyWALL comes with the (non-removable) System Default PPP interfaces pre-configured. You can create (and delete) User Configuration PPP interfaces.
Add	Click this to create a new user-configured PPP interface.
Edit	Double-click an entry or select it and click Edit to open a screen where you can modify the entry's settings.
Remove	To remove a user-configured PPP interface, select it and click Remove . The ZyWALL confirms you want to remove it before doing so.
Activate	To turn on an entry, select it and click Activate .
Inactivate	To turn off an entry, select it and click Inactivate .
Connect	To connect an interface, select it and click Connect . You might use this in testing the interface or to manually establish the connection for a Dial-on-Demand PPPoE/PPTP interface.
Disconnect	To disconnect an interface, select it and click Disconnect . You might use this in testing the interface.
Object References	Select an entry and click Object References to open a screen that shows which settings use the entry. See Section 11.3.2 on page 232 for an example.
#	This field is a sequential value, and it is not associated with any interface.

Table 53 Configuration > Network > Interface > PPP (continued)

LABEL	DESCRIPTION
Status	The activate (light bulb) icon is lit when the entry is active and dimmed when the entry is inactive. The connect icon is lit when the interface is connected and dimmed when it is disconnected.
Name	This field displays the name of the interface.
Base Interface	This field displays the interface on the top of which the PPPoE/PPTP interface is.
Account Profile	This field displays the ISP account used by this PPPoE/PPTP interface.
Apply	Click Apply to save your changes back to the ZyWALL.
Reset	Click Reset to return the screen to its last-saved settings.

11.4.2 PPP Interface Add or Edit

Note: You have to set up an ISP account before you create a PPPoE/PPTP interface.

This screen lets you configure a PPPoE or PPTP interface. To access this screen, click the **Add** icon or an **Edit** icon in the PPP Interface screen.

Figure 164 Configuration > Network > Interface > PPP > Add

Add PPPoE/PPTP

Hide Advanced Settings Create new Object

General Settings

Enable Interface

Interface Properties

Interface Name: !

Base Interface:

Zone:

Description: (Optional)

Connectivity

Nailed-Up

Dial-on-Demand

ISP Setting

Account Profile:

IP Address Assignment

Get Automatically 0.0.0.0

Use Fixed IP Address

IP Address:

Metric: (0-15)

Interface Parameters

Egress Bandwidth: Kbps

Ingress Bandwidth: Kbps

MTU: Bytes

Connectivity Check

Enable Connectivity Check

Check Method:

Check Period: (5-30 seconds)

Check Timeout: (1-10 seconds)

Check Fail Tolerance: (1-10)

Check Default Gateway 0.0.0.0

Check this address (Domain Name or IP Address)

Related Setting

Configure [WAN_TRUNK](#)

Configure [Policy Route](#)

Each field is explained in the following table.

Table 54 Configuration > Network > Interface > PPP > Add

LABEL	DESCRIPTION
Show Advance Settings / Hide Advance Settings	Click this button to display a greater or lesser number of configuration fields.
General Settings	
Enable Interface	Select this to enable this interface. Clear this to disable this interface.
Interface Properties	
Interface Name	Specify a name for the interface. It can use alphanumeric characters, hyphens, and underscores, and it can be up to 11 characters long.
Base Interface	Select the interface upon which this PPP interface is built. Note: Multiple PPP interfaces can use the same base interface.
Description	Enter a description of this interface. It is not used elsewhere. You can use alphanumeric and () + / : = ? ! * # @ \$ _ % - characters, and it can be up to 60 characters long.
Connectivity	
Nailed-Up	Select this if the PPPoE/PPTP connection should always be up. Clear this to have the ZyWALL establish the PPPoE/PPTP connection only when there is traffic. You might use this option if a lot of traffic needs to go through the interface or it does not cost extra to keep the connection up all the time.
Dial-on-Demand	Select this to have the ZyWALL establish the PPPoE/PPTP connection only when there is traffic. You might use this option if there is little traffic through the interface or if it costs money to keep the connection available.
ISP Setting	
Account Profile	Select the ISP account that this PPPoE/PPTP interface uses. The drop-down box lists ISP accounts by name. Use Create new Object if you need to configure a new ISP account (see Chapter 40 on page 611 for details).
Protocol	This field is read-only. It displays the protocol specified in the ISP account.
User Name	This field is read-only. It displays the user name for the ISP account.
Service Name	This field is read-only. It displays the PPPoE service name specified in the ISP account. This field is blank if the ISP account uses PPTP.
IP Address Assignment	Click Show Advanced Settings to display more settings. Click Hide Advanced Settings to display fewer settings.
Get Automatically	Select this if this interface is a DHCP client. In this case, the DHCP server configures the IP address automatically. The subnet mask and gateway are always defined automatically in PPPoE/PPTP interfaces.
Use Fixed IP Address	Select this if you want to specify the IP address manually.

Table 54 Configuration > Network > Interface > PPP > Add (continued)

LABEL	DESCRIPTION
IP Address	This field is enabled if you select Use Fixed IP Address . Enter the IP address for this interface.
Metric	Enter the priority of the gateway (the ISP) on this interface. The ZyWALL decides which gateway to use based on this priority. The lower the number, the higher the priority. If two or more gateways have the same priority, the ZyWALL uses the one that was configured first.
Interface Parameters	
Egress Bandwidth	Enter the maximum amount of traffic, in kilobits per second, the ZyWALL can send through the interface to the network. Allowed values are 0 - 1048576.
Ingress Bandwidth	This is reserved for future use. Enter the maximum amount of traffic, in kilobits per second, the ZyWALL can receive from the network through the interface. Allowed values are 0 - 1048576.
MTU	Maximum Transmission Unit. Type the maximum size of each data packet, in bytes, that can move through this interface. If a larger packet arrives, the ZyWALL divides it into smaller fragments. Allowed values are 576 - 1492. Usually, this value is 1492.
Connectivity Check	The interface can regularly check the connection to the gateway you specified to make sure it is still available. You specify how often the interface checks the connection, how long to wait for a response before the attempt is a failure, and how many consecutive failures are required before the ZyWALL stops routing to the gateway. The ZyWALL resumes routing to the gateway the first time the gateway passes the connectivity check.
Enable Connectivity Check	Select this to turn on the connection check.
Check Method	Select the method that the gateway allows. Select icmp to have the ZyWALL regularly ping the gateway you specify to make sure it is still available. Select tcp to have the ZyWALL regularly perform a TCP handshake with the gateway you specify to make sure it is still available.
Check Period	Enter the number of seconds between connection check attempts.
Check Timeout	Enter the number of seconds to wait for a response before the attempt is a failure.
Check Fail Tolerance	Enter the number of consecutive failures before the ZyWALL stops routing through the gateway.
Check Default Gateway	Select this to use the default gateway for the connectivity check.
Check this address	Select this to specify a domain name or IP address for the connectivity check. Enter that domain name or IP address in the field next to it.
Check Port	This field only displays when you set the Check Method to tcp . Specify the port number to use for a TCP connectivity check.

Table 54 Configuration > Network > Interface > PPP > Add (continued)

LABEL	DESCRIPTION
Related Setting	
Configure WAN TRUNK	Click WAN TRUNK to go to a screen where you can configure the interface as part of a WAN trunk for load balancing.
Policy Route	Click Policy Route to go to the screen where you can manually configure a policy route to associate traffic with this interface.
OK	Click OK to save your changes back to the ZyWALL.
Cancel	Click Cancel to exit this screen without saving.

11.5 Cellular Configuration Screen (3G)

3G (Third Generation) is a digital, packet-switched wireless technology. Bandwidth usage is optimized as multiple users share the same channel and bandwidth is only allocated to users when they send data. It allows fast transfer of voice and non-voice data and provides broadband Internet access to mobile devices.

Note: The actual data rate you obtain varies depending on the 3G card you use, the signal strength to the service provider's base station, and so on.

- (refer to [Section 11.5.1 on page 241](#)).
- You can set the 3G device to connect to other networks if the signal strength of the home network is too low or it is unavailable.

Aside from selecting the 3G network, the 3G card may also select an available 2.5G or 2.75G network automatically. See the following table for a comparison between 2G, 2.5G, 2.75G and 3G of wireless technologies.

Table 55 2G, 2.5G, 2.75G, 3G and 3.5G Wireless Technologies

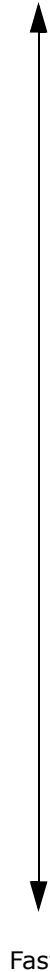
NAME	TYPE	MOBILE PHONE AND DATA STANDARDS		DATA SPEED
		GSM-BASED	CDMA-BASED	
2G	Circuit-switched	GSM (Global System for Mobile Communications), Personal Handy-phone System (PHS), etc.	Interim Standard 95 (IS-95), the first CDMA-based digital cellular standard pioneered by Qualcomm. The brand name for IS-95 is cdmaOne. IS-95 is also known as TIA-EIA-95.	
2.5G	Packet-switched	GPRS (General Packet Radio Services), High-Speed Circuit-Switched Data (HSCSD), etc.	CDMA2000 is a hybrid 2.5G / 3G protocol of mobile telecommunications standards that use CDMA, a multiple access scheme for digital radio.	
2.75G	Packet-switched	Enhanced Data rates for GSM Evolution (EDGE), Enhanced GPRS (EGPRS), etc.	CDMA2000 1xRTT (1 times Radio Transmission Technology) is the core CDMA2000 wireless air interface standard. It is also known as 1x, 1xRTT, or IS-2000 and considered to be a 2.5G or 2.75G technology.	
3G	Packet-switched	UMTS (Universal Mobile Telecommunications System), a third-generation (3G) wireless standard defined in ITU ^A specification, is sometimes marketed as 3GSM. The UMTS uses GSM infrastructures and W-CDMA (Wideband Code Division Multiple Access) as the air interface.	CDMA2000 EV-DO (Evolution-Data Optimized, originally 1x Evolution-Data Only), also referred to as EV-DO, EVDO, or just EV, is an evolution of CDMA2000 1xRTT and enables high-speed wireless connectivity. It is also denoted as IS-856 or High Data Rate (HDR).	
3.5G	Packet-switched	HSDPA (High-Speed Downlink Packet Access) is a mobile telephony protocol, used for UMTS-based 3G networks and allows for higher data transfer speeds.		

A. The International Telecommunication Union (ITU) is an international organization within which governments and the private sector coordinate global telecom networks and services.

To change your 3G WAN settings, click **Configuration > Network > Interface > Cellular**.

Note: Install (or connect) a compatible 3G USB to use a cellular connection. See [Chapter 51 on page 741](#) for details.

Note: The WAN IP addresses of a ZyWALL with multiple WAN interfaces must be on different subnets.

Figure 165 Configuration > Network > Interface > Cellular

#	Status	Name	Extension Slot	Connected Device	ISP Settings
1		cellular1	USB 1	none	Device Profile 1

The following table describes the labels in this screen.

Table 56 Configuration > Network > Interface > Cellular

LABEL	DESCRIPTION
Add	Click this to create a new cellular interface.
Edit	Double-click an entry or select it and click Edit to open a screen where you can modify the entry's settings.
Remove	To remove an entry, select it and click Remove . The ZyWALL confirms you want to remove it before doing so.
Activate	To turn on an entry, select it and click Activate .
Inactivate	To turn off an entry, select it and click Inactivate .
Connect	To connect an interface, select it and click Connect . You might use this in testing the interface or to manually establish the connection.
Disconnect	To disconnect an interface, select it and click Disconnect . You might use this in testing the interface.
Object References	Select an entry and click Object References to open a screen that shows which settings use the entry. See Section 11.3.2 on page 232 for an example.
#	This field is a sequential value, and it is not associated with any interface.
Status	The activate (light bulb) icon is lit when the entry is active and dimmed when the entry is inactive. The connect icon is lit when the interface is connected and dimmed when it is disconnected.
Name	This field displays the name of the interface.
Extension Slot	This field displays where the entry's cellular card is located.
Connected Device	This field displays the name of the cellular card.
ISP Settings	This field displays the profile of ISP settings that this cellular interface is set to use.
Apply	Click Apply to save your changes back to the ZyWALL.
Reset	Click Reset to return the screen to its last-saved settings.

11.5.1 Cellular Add/Edit Screen

To change your 3G settings, click **Configuration > Network > Interface > Cellular > Add** (or **Edit**). In the pop-up window that displays, select the slot that you want to configure. The following screen displays.

Figure 166 Configuration > Network > Interface > Cellular > Add

Add Cellular configuration

Hide Advanced Settings

General Settings

Enable Interface

Interface Properties

Interface Name: cellular1
 Zone: none
 Extension Slot: USB 1
 Connected Device: none
 Description: (Optional)

Connectivity

Nailed-Up
 Idle timeout: 0 seconds

ISP Settings

Profile Selection: Device Custom
 Profile 1
 APN: n/a
 Dial String: n/a

SIM Card Setting

PIN Code:

Interface Parameters

Egress Bandwidth: 1048576 Kbps
 Ingress Bandwidth: 1048576 Kbps
 MTU: 1492 Bytes

Connectivity Check

Enable Connectivity Check
 Check Method: icmp
 Check Period: 30 (5-30 seconds)
 Check Timeout: 5 (1-10 seconds)
 Check Fail Tolerance: 5 (1-10)
 Check Default Gateway: 0.0.0.0
 Check this address: (Domain Name or IP Address)

Related Setting

[Configure WAN_TRUNK](#)
[Configure Policy_Route](#)

IP Address Assignment

Get Automatically: 0.0.0.0
 Use Fixed IP Address
 IP Address Assignment:
 Metric: 0 (0-15)

Device Settings

Device Selection: Huawei E220/E270/E800/E11
 Band Selection: auto
 Network Selection: auto

Budget Setup

Enable Budget Control
 Time Budget: 1 hours per month
 Data Budget: 1 Mbytes Download/Upload per month
 Reset time and data budget counters on: Last day of each month
 Actions when over budget
 Log: None
 New 3G connection: Allow
 Current 3G connection: Keep
 Actions when over 0 % of time budget or 0 % of data budget
 Log: None

Apply Cancel OK Cancel

The following table describes the labels in this screen.

Table 57 Configuration > Network > Interface > Cellular > Add

LABEL	DESCRIPTION
Show Advance Settings / Hide Advance Settings	Click this button to display a greater or lesser number of configuration fields.
General Settings	
Enable Interface	Select this option to turn on this interface.
Interface Properties	
Interface Name	Select a name for the interface.
Zone	Select the zone to which you want the cellular interface to belong. The zone determines the security settings the ZyWALL uses for the interface.
Extension Slot	This is the USB slot that you are configuring for use with a 3G card.
Connected Device	This displays the manufacturer and model name of your 3G card if you inserted one in the ZyWALL. Otherwise, it displays none .
Description	Enter a description of this interface. It is not used elsewhere. You can use alphanumeric and ()+ / : = ? ! * # @ \$ _ % - characters, and it can be up to 60 characters long.
Connectivity	
Nailed-Up	Select this if the connection should always be up. Clear this to have the ZyWALL to establish the connection only when there is traffic. You might not nail up the connection if there is little traffic through the interface or if it costs money to keep the connection available.
Idle timeout	This value specifies the time in seconds (0~360) that elapses before the ZyWALL automatically disconnects from the ISP's server. Zero disables the idle timeout.
ISP Settings	
Profile Selection	Select Device to use one of the 3G device's profiles of device settings. Then select the profile (use Profile 1 unless your ISP instructed you to do otherwise). Select Custom to configure your device settings yourself.
APN	This field is read-only if you selected Device in the profile selection. Select Custom in the profile selection to be able to manually input the APN (Access Point Name) provided by your service provider. This field applies with a GSM or HSDPA 3G card. Enter the APN from your service provider. Connections with different APNs may provide different services (such as Internet access or MMS (Multi-Media Messaging Service)) and charge method. You can enter up to 63 ASCII printable characters. Spaces are allowed.

Table 57 Configuration > Network > Interface > Cellular > Add (continued)

LABEL	DESCRIPTION
Dial String	<p>Enter the dial string if your ISP provides a string, which would include the APN, to initialize the 3G card.</p> <p>You can enter up to 63 ASCII printable characters. Spaces are allowed.</p> <p>This field is available only when you insert a GSM 3G card.</p>
Authentication Type	<p>The ZyWALL supports PAP (Password Authentication Protocol) and CHAP (Challenge Handshake Authentication Protocol). CHAP is more secure than PAP; however, PAP is readily available on more platforms.</p> <p>Use the drop-down list box to select an authentication protocol for outgoing calls. Options are:</p> <p>None: No authentication for outgoing calls.</p> <p>CHAP - Your ZyWALL accepts CHAP requests only.</p> <p>PAP - Your ZyWALL accepts PAP requests only.</p>
User Name	<p>This field displays when you select an authentication type other than None. This field is read-only if you selected Device in the profile selection. If this field is configurable, enter the user name for this 3G card exactly as the service provider gave it to you.</p> <p>You can use 1 ~ 64 alphanumeric and #:%_@\$./ characters. The first character must be alphanumeric or -_@\$./ . Spaces are not allowed.</p>
Password	<p>This field displays when you select an authentication type other than None. This field is read-only if you selected Device in the profile selection and the password is included in the 3G card's profile. If this field is configurable, enter the password for this SIM card exactly as the service provider gave it to you.</p> <p>You can use 0 ~ 63 alphanumeric and `~!@#\$\$%^&*()_+={ } ; : ' < , > . / characters. Spaces are not allowed.</p>
Retype to Confirm	<p>This field displays when you select an authentication type other than None. This field is read-only if you selected Device in the profile selection and the password is included in the 3G card's profile. If this field is configurable, re-enter the password for this SIM card exactly as the service provider gave it to you.</p>
SIM Card Setting	
PIN Code	<p>This field displays with a GSM or HSDPA 3G card. A PIN (Personal Identification Number) code is a key to a 3G card. Without the PIN code, you cannot use the 3G card.</p> <p>Enter the 4-digit PIN code (0000 for example) provided by your ISP. If you enter the PIN code incorrectly, the 3G card may be blocked by your ISP and you cannot use the account to access the Internet.</p> <p>If your ISP disabled PIN code authentication, enter an arbitrary number.</p>
Interface Parameters	

Table 57 Configuration > Network > Interface > Cellular > Add (continued)

LABEL	DESCRIPTION
Egress Bandwidth	Enter the maximum amount of traffic, in kilobits per second, the ZyWALL can send through the interface to the network. Allowed values are 0 - 1048576. This setting is used in WAN load balancing and bandwidth management.
Ingress Bandwidth	This is reserved for future use. Enter the maximum amount of traffic, in kilobits per second, the ZyWALL can receive from the network through the interface. Allowed values are 0 - 1048576.
MTU	Maximum Transmission Unit. Type the maximum size of each data packet, in bytes, that can move through this interface. If a larger packet arrives, the ZyWALL divides it into smaller fragments. Allowed values are 576 - 1492. Usually, this value is 1492.
Connectivity Check	The interface can regularly check the connection to the gateway you specified to make sure it is still available. You specify how often the interface checks the connection, how long to wait for a response before the attempt is a failure, and how many consecutive failures are required before the ZyWALL stops routing to the gateway. The ZyWALL resumes routing to the gateway the first time the gateway passes the connectivity check.
Enable Connectivity Check	Select this to turn on the connection check.
Check Method	Select the method that the gateway allows. Select icmp to have the ZyWALL regularly ping the gateway you specify to make sure it is still available. Select tcp to have the ZyWALL regularly perform a TCP handshake with the gateway you specify to make sure it is still available.
Check Period	Enter the number of seconds between connection check attempts.
Check Timeout	Enter the number of seconds to wait for a response before the attempt is a failure.
Check Fail Tolerance	Enter the number of consecutive failures before the ZyWALL stops routing through the gateway.
Check Default Gateway	Select this to use the default gateway for the connectivity check.
Check this address	Select this to specify a domain name or IP address for the connectivity check. Enter that domain name or IP address in the field next to it.
Check Port	This field only displays when you set the Check Method to tcp . Specify the port number to use for a TCP connectivity check.
Related Setting	
Configure WAN TRUNK	Click WAN TRUNK to go to a screen where you can configure the interface as part of a WAN trunk for load balancing.
Configure Policy Route	Click Policy Route to go to the policy route summary screen where you can configure a policy route to override the default routing and SNAT behavior for the interface.
IP Address Assignment	

Table 57 Configuration > Network > Interface > Cellular > Add (continued)

LABEL	DESCRIPTION
Get Automatically	Select this option If your ISP did not assign you a fixed IP address. This is the default selection.
Use Fixed IP Address	Select this option If the ISP assigned a fixed IP address.
IP Address Assignment	Enter the cellular interface's WAN IP address in this field if you selected Use Fixed IP Address .
Metric	Enter the priority of the gateway (if any) on this interface. The ZyWALL decides which gateway to use based on this priority. The lower the number, the higher the priority. If two or more gateways have the same priority, the ZyWALL uses the one that was configured first.
Device Settings	
Device Selection	Select the 3G card to use with this entry or select auto to have the ZyWALL automatically detect the type of card.
Band Selection	<p>This field appears if you selected a 3G device that allows you to select the type of network to use. Select the type of 3G service for your 3G connection. If you are unsure what to select, check with your 3G service provider to find the 3G service available to you in your region.</p> <p>Select auto to have the card connect to an available network. Choose this option if you do not know what networks are available.</p> <p>You may want to manually specify the type of network to use if you are charged differently for different types of network or you only have one type of network available to you.</p> <p>Select GPRS / EDGE (GSM) only to have this interface only use a 2.5G or 2.75G network (respectively). If you only have a GSM network available to you, you may want to select this so the ZyWALL does not spend time looking for a WCDMA network.</p> <p>Select UMTS / HSDPA (WCDMA) only to have this interface only use a 3G or 3.5G network (respectively). You may want to do this if you want to make sure the interface does not use the GSM network.</p>
Network Selection	<p>Home network is the network to which you are originally subscribed.</p> <p>Select Home to have the 3G device connect only to the home network. If the home network is down, the ZyWALL's 3G Internet connection is also unavailable.</p> <p>Select Auto (Default) to allow the 3G device to connect to a network to which you are not subscribed when necessary, for example when the home network is down or another 3G base station's signal is stronger. This is recommended if you need continuous Internet connectivity. If you select this, you may be charged using the rate of a different network.</p>
Budget Setup	
Enable Budget Control	Select this to set a monthly limit for the user account of the installed 3G card. You can set a limit on the total traffic and/or call time. The ZyWALL takes the actions you specified when a limit is exceeded during the month.

Table 57 Configuration > Network > Interface > Cellular > Add (continued)

LABEL	DESCRIPTION
Time Budget	Select this and specify the amount of time (in hours) that the 3G connection can be used within one month. If you change the value after you configure and enable budget control, the ZyWALL resets the statistics.
Data Budget	<p>Select this and specify how much downstream and/or upstream data (in Mega bytes) can be transmitted via the 3G connection within one month.</p> <p>Select Download to set a limit on the downstream traffic (from the ISP to the ZyWALL).</p> <p>Select Upload to set a limit on the upstream traffic (from the ZyWALL to the ISP).</p> <p>Select Download/Upload to set a limit on the total traffic in both directions.</p> <p>If you change the value after you configure and enable budget control, the ZyWALL resets the statistics.</p>
Reset time and data budget counters on	Select the date on which the ZyWALL resets the budget every month. If the date you selected is not available in a month, such as 30th or 31th, the ZyWALL resets the budget on the last day of the month.
Reset time and data budget counters	<p>This button is available only when you enable budget control in this screen.</p> <p>Click this button to reset the time and data budgets immediately. The count starts over with the 3G connection's full configured monthly time and data budgets. This does not affect the normal monthly budget restart; so if you configured the time and data budget counters to reset on the second day of the month and you use this button on the first, the time and data budget counters will still reset on the second.</p>
Actions when over budget	Specify the actions the ZyWALL takes when the time or data limit is exceeded.
Log	Select None to not create a log, Log to create a log, or Log-alert to create an alert log. If you select Log or Log-alert you can also select recurring every to have the ZyWALL send a log or alert for this event periodically. Specify how often (from 1 to 65535 minutes) to send the log or alert.
New 3G connection	Select Allow to permit new 3G connections or Disallow to drop/block new 3G connections.
Current 3G connection	<p>Select Keep to maintain an existing 3G connection or Drop to disconnect it. You cannot set New 3G connection to Allow and Current 3G connection to Drop at the same time.</p> <p>If you set New 3G connection to Disallow and Current 3G connection to Keep, the ZyWALL allows you to transmit data using the current connection, but you cannot build a new connection if the existing connection is disconnected.</p>

Table 57 Configuration > Network > Interface > Cellular > Add (continued)

LABEL	DESCRIPTION
Actions when over % of time budget or % of data budget	Specify the actions the ZyWALL takes when the specified percentage of time budget or data limit is exceeded. Enter a number from 1 to 99 in the percentage fields. If you change the value after you configure and enable budget control, the ZyWALL resets the statistics. Select None to not create a log when the ZyWALL takes this action, Log to create a log, or Log-alert to create an alert log. If you select Log or Log-alert you can also select recurring every to have the ZyWALL send a log or alert for this event periodically. Specify how often (from 1 to 65535 minutes) to send the log or alert.
OK	Click OK to save your changes back to the ZyWALL.
Cancel	Click Cancel to exit this screen without saving.

11.6 WLAN Interface General Screen

This feature is available for USG 20W only.

The following figure provides an example of a wireless network. The wireless network is in the blue circle. Wireless clients (A and B) connect to an access point (AP) to access other devices (such as the printer) or the Internet. Your ZyWALL works as an AP when you install a compatible WLAN card.

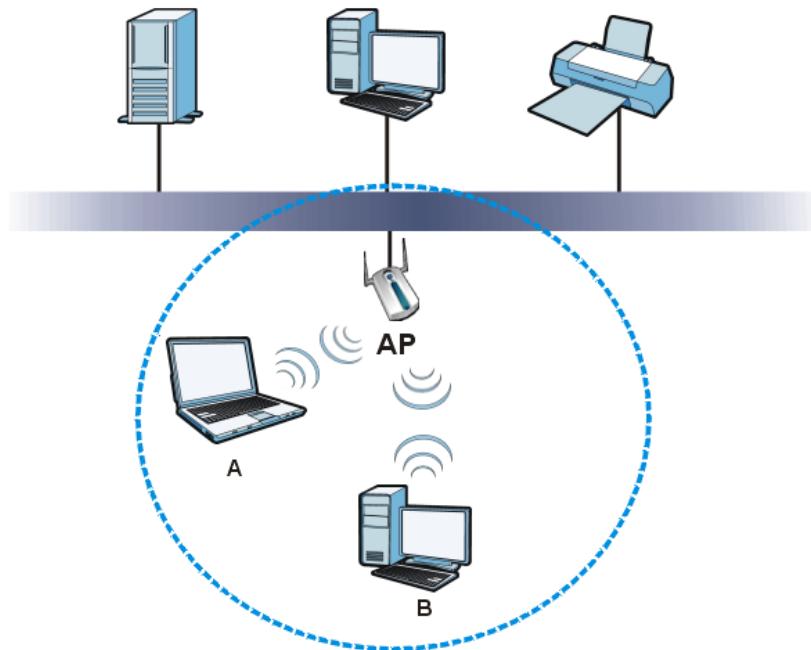
Figure 167 Example of a Wireless Network

- Every device in a wireless network must use the same SSID.
The SSID is the name of the wireless network. It stands for Service Set Identity.
- Different wireless networks in the same area should use different channels.
Like radio stations or television channels, each wireless network uses a specific channel, or frequency, to send and receive information.
- Every wireless client in a wireless network must use security compatible with the AP.
Security stops unauthorized devices from using the wireless network and can protect the information that is sent in the wireless network.

Click **Configuration > Network > Interface > WLAN** to open the following screen. See [Appendix C on page 803](#) for more details on wireless LANs.

Figure 168 Configuration > Network > Interface > WLAN

The screenshot displays the configuration page for a WLAN interface. The 'General' tab is selected, showing various settings for the WLAN device. The '802.11n Settings' section is also visible, with several options checked. The 'Interface Summary' table at the bottom provides a quick overview of the configured WLAN interface.

#	St...	Name	SSID	IP Address	Mask	Security
1		wlan-1-1	ZyXEL01	10.59.1.1	255.255.255.0	none

The following table describes the labels in this screen.

Table 58 Configuration > Network > Interface > WLAN

LABEL	DESCRIPTION
Show Advance Settings / Hide Advance Settings	Click this button to display a greater or lesser number of configuration fields.
Enable WLAN Device	Select this to turn on the wireless LAN card. It is recommended that you configure the wireless security settings before you use this option to turn on a wireless LAN card.
802.11 Band	<p>Select whether you will let wireless clients connect to the ZyWALL using IEEE 802.11b, IEEE 802.11g, or both.</p> <p>Select b Only to allow only IEEE 802.11b compliant WLAN devices to associate with the ZyWALL.</p> <p>Select g Only to allow only IEEE 802.11g compliant WLAN devices to associate with the ZyWALL.</p> <p>Select b+g to allow both IEEE802.11b and IEEE802.11g compliant WLAN devices to associate with the ZyWALL. The transmission rate of your ZyWALL might be reduced.</p> <p>Select b+g+n to allow IEEE802.11b, IEEE802.11g and IEEE802.11n compliant WLAN devices to associate with the ZyWALL. The transmission rate of your ZyWALL might be reduced.</p> <p>Select g+n to allow both IEEE802.11g and IEEE802.11n compliant WLAN devices to associate with the ZyWALL. The transmission rate of your ZyWALL might be reduced.</p>
Channel	This allows you to set the operating channel depending on your particular region. Select a channel from the drop-down list box.
CTS/RTS Threshold	<p>Use CTS/RTS to reduce data collisions on the wireless network if you have wireless clients that are associated with the same AP but out of range of one another. When enabled, a wireless client sends an RTS (Request To Send) and then waits for a CTS (Clear To Send) before it transmits. This stops wireless clients from transmitting packets at the same time (and causing data collisions).</p> <p>A wireless client sends an RTS for all packets larger than the number (of bytes) that you enter here. Set the RTS/CTS equal to or higher than the fragmentation threshold to turn RTS/CTS off.</p>
Fragmentation Threshold	This is the threshold (number of bytes) for the fragmentation boundary for directed messages. It is the maximum data fragment size that can be sent.
Output Power	Select the percentage of output power that this WLAN card is to use. If there is a high density of APs in the area, decrease the output power of the ZyWALL to reduce interference with other APs. See the product specifications for more information on your ZyWALL's output power.

Table 58 Configuration > Network > Interface > WLAN

LABEL	DESCRIPTION
QoS	<p>Select the Quality of Service priority for this traffic.</p> <ul style="list-style-type: none"> If you select WMM (Wi-Fi Multimedia) from the QoS list, the priority of a data packet depends on the packet's IEEE 802.1q or DSCP header. If a packet has no WMM value assigned to it, it is assigned the default priority. If you select NONE, the ZyWALL applies no priority to traffic on this SSID.
802.11n Settings	
Aggregation MSDU(A-MSDU)	<p>This field is available only when 802.11b+g+n or 802.11g+n is selected as the 802.11 Band.</p> <p>Check this to allow the grouping of several A-MSDUs (Aggregate MAC Service Data Units) into one large A-MPDU (Aggregate MAC Protocol Data Unit). This function allows faster data transfer rates.</p>
Auto Block ACK	<p>This field is available only when 802.11b+g+n or 802.11g+n is selected as the 802.11 Band.</p> <p>Check this to add the block ACK (BA) mechanism, in which multiple frames can be streamed out and acknowledged by a single frame. This function allows cutting the wait time between frames and increasing the data throughput.</p>
Guard Interval	<p>This field is available only when 802.11b+g+n or 802.11g+n is selected as the 802.11 Band.</p> <p>Select Short to increase data throughput. However, this may make data transfer more prone to errors.</p> <p>Select Long to prioritize data integrity. This may be because your wireless network is busy and congested.</p> <p>The guard interval is the gap introduced between data transmission from users in order to reduce interference. Reducing the GI increases data transfer rates but also increases interference. Increasing the GI reduces data transfer rates but also reduces interference.</p>
Add	Click this to create a new WLAN interface.
Edit	Double-click an entry or select it and click Edit to open a screen where you can modify the entry's settings.
Remove	To remove an entry, select it and click Remove . The ZyWALL confirms you want to remove it before doing so.
Activate	To turn on an entry, select it and click Activate .
Inactivate	To turn off an entry, select it and click Inactivate .
Object References	Select an entry and click Object References to open a screen that shows which settings use the entry. See Section 11.3.2 on page 232 for an example.
#	This field is a sequential value, and it is not associated with any interface.
Status	This icon is lit when the entry is active and dimmed when the entry is inactive.
Name	This field displays the name of the WLAN interface.
SSID	This is the SSID (Service Set IDentity) of the WLAN interface.

Table 58 Configuration > Network > Interface > WLAN

LABEL	DESCRIPTION
IP Address	This field displays the current IP address of the WLAN interface. If the IP address is 0.0.0.0, the interface does not have an IP address yet. This screen also shows whether the IP address is a static IP address (STATIC) or dynamically assigned (DHCP). IP addresses are always static in virtual interfaces.
Mask	This field displays the interface's subnet mask in dot decimal notation.
Security	This field displays what type of security the WLAN interface uses.
Apply	Click Apply to save your changes back to the ZyWALL.
Reset	Click Reset to return the screen to its last-saved settings.

11.6.1 WLAN Add/Edit Screen

Use the strongest security that every wireless client in the wireless network supports.

Table 59 Wireless Security Levels

SECURITY LEVEL	SECURITY TYPE
	WPA2
	WPA-PSK2
	WPA (Wi-Fi Protected Access)
	WPA-PSK (Wi-Fi Protected Access Pre-Shared Key)
	IEEE 802.1x EAP with RADIUS Server Authentication
	WEP Encryption
	MAC Address Filtering
	No Security
Weakest	

Note: WPA2 or WPA2-PSK security is recommended.

- You can use the ZyWALL's local user database to use WPA or WPA2 without using an external RADIUS server. With WPA or WPA2, users have to log into the wireless network before using it. This is called user authentication. WPA and WPA2 are also called the enterprise version of WPA).
- WPA2-PSK and WPA-PSK do not employ user authentication and are known as the personal version of WPA.
- WEP is better than no security, but it is still possible for unauthorized devices to figure out the original information pretty quickly.

Click **Configuration > Network > Interface > WLAN > Add** (or **Edit**) to open the **WLAN Edit** screen. The screen varies according to the security features you select. It displays as shown next when you set the **Security Type** to **none**.

Figure 169 Configuration > Network > Interface > WLAN > Add (No Security)

Add WLAN [?] [X]

Hide Advanced Settings

General Settings

Enable Interface

Interface Name: wlan-1-2

Description: (Optional)

Zone: ▼

Virtual Access Point Settings

SSID: ZyXEL02

Hide SSID Broadcast

Block Intra BSS Traffic

Maximum Associations:

WLAN Security Settings

Security Type: none ▼

802.1x

Radius Server IP Address:

Radius Server Port:

Radius Server Secret:

IP Address Assignment

IP Address:

Subnet Mask:

Interface Parameters

Egress Bandwidth: Kbps

Ingress Bandwidth: Kbps

MTU: Bytes

DHCP Setting

DHCP: None ▼

RIP Setting

Enable RIP

Direction: BDir ▼

Send Version: 2 ▼

Receive Version: 2 ▼

V2-Broadcast

OSPF Setting

Area: none ▼

Priority: (0-255)

Link Cost: (1-65535)

Passive Interface

Authentication: None ▼

OK Cancel

The following table describes the general wireless LAN labels in this screen.

Table 60 Configuration > Network > Interface > WLAN > Add (No Security)

LABEL	DESCRIPTION
Show Advance Settings / Hide Advance Settings	Click this button to display a greater or lesser number of configuration fields.
General Settings	
Enable Interface	Select this option to turn on the wireless LAN interface.
Interface Name	This shows the name for this wireless LAN interface.
Description	Enter a description of this interface. It is not used elsewhere. You can use alphanumeric and () + / : = ? ! * # @ \$ _ % - characters, and it can be up to 60 characters long.
Zone	Select the zone to which you want the WLAN interface to belong.
Virtual Access Point Settings	
SSID	(Service Set IDentity) The SSID identifies the Service Set with which a wireless station is associated. Wireless stations associating to the access point (AP) must have the same SSID. Enter a descriptive name (up to 32 printable 7-bit ASCII characters) for the wireless LAN. To make your wireless network more secure, change the default SSID to something that is difficult to guess.
Hide SSID Broadcast	Select to hide the SSID in the outgoing beacon frame so a station cannot obtain the SSID through scanning.
Block Intra BSS Traffic	Select this to prevent wireless clients in this profile's BSS from communicating with one another.
Maximum Associations	Specify the highest number of wireless clients that are allowed to connect to the wireless interface at the same time.
WLAN Security Settings	
Security Type	Use this field to select the type of security to use for this wireless LAN interface. Select none to not use any security. See the following sections for details on the other security types.
802.1x	Authentication server (IEEE 802.1x) settings are available when you use no security or WEP security and click Advanced . Select the check box to enable wireless user authentication through an external authentication server.
Radius Server IP Address	Enter the IP address of the external authentication server in dotted decimal notation.
Radius Server Port	Enter the RADIUS server's listening port number (the default is 1812).
Radius Server Secret	Enter a password (up to 31 alphanumeric characters) as the key to be shared between the external authentication server and the ZyWALL. The key is not sent over the network. This key must be the same on the external authentication server and ZyWALL.
IP Address Assignment	

Table 60 Configuration > Network > Interface > WLAN > Add (No Security)

LABEL	DESCRIPTION
IP Address	Enter the IP address for this interface.
Subnet Mask	Enter the subnet mask of this interface in dot decimal notation. The subnet mask indicates what part of the IP address is the same for all computers in the network.
Interface Parameters	
Egress Bandwidth	Enter the maximum amount of traffic, in kilobits per second, the ZyWALL can send through the interface to the network. Allowed values are 0 - 1048576. This setting is used in WAN load balancing and bandwidth management.
Ingress Bandwidth	This is reserved for future use. Enter the maximum amount of traffic, in kilobits per second, the ZyWALL can receive from the network through the interface. Allowed values are 0 - 1048576.
MTU	Maximum Transmission Unit. Type the maximum size of each data packet, in bytes, that can move through this interface. If a larger packet arrives, the ZyWALL divides it into smaller fragments. Allowed values are 576 - 1500. Usually, this value is 1500.
DHCP Settings	
DHCP	Select what type of DHCP service the ZyWALL provides to the wireless network. Choices are: None - the ZyWALL does not provide any DHCP services. There is already a DHCP server on the network. DHCP Relay - the ZyWALL routes DHCP requests to one or more DHCP servers you specify. The DHCP server(s) may be on another network. DHCP Server - the ZyWALL assigns IP addresses and provides subnet mask, gateway, and DNS server information to the network. The ZyWALL is the DHCP server for the network.
	These fields appear if the ZyWALL is a DHCP Relay .
Relay Server 1	Enter the IP address of a DHCP server for the network.
Relay Server 2	This field is optional. Enter the IP address of another DHCP server for the network.
	These fields appear if the ZyWALL is a DHCP Server .
IP Pool Start Address	Enter the IP address from which the ZyWALL begins allocating IP addresses. If this field is blank, the ZyWALL assigns every IP address allowed by the interface's IP address, subnet mask, and pool size; except for the first address (network address), last address (broadcast address) and the interface's IP address.

Table 60 Configuration > Network > Interface > WLAN > Add (No Security)

LABEL	DESCRIPTION
Pool Size	<p>Enter the number of IP addresses to allocate. This number must be at least one and is limited by the interface's Subnet Mask. For example, if the Subnet Mask is 255.255.255.0 and IP Pool Start Address is 10.10.10.10, the ZyWALL can allocate 10.10.10.10 to 10.10.10.254, or 245 IP addresses.</p> <p>If this field is blank, the ZyWALL can assign every IP address allowed by the interface's IP address, subnet mask, and IP Pool Start Address; except for the first address (network address), last address (broadcast address) and the interface's IP address.</p>
First DNS Server Second DNS Server Third DNS Server	<p>Specify the IP addresses of a maximum of three DNS servers that the network can use. The ZyWALL provides these IP addresses to DHCP clients. Use one of the following ways to specify these IP addresses.</p> <p>Custom Defined - enter a static IP address.</p> <p>From ISP - select the DNS server that another interface received from its DHCP server.</p> <p>ZyWALL - the ZyWALL uses the IP address of this interface and works as a DNS relay.</p>
First WINS Server, Second WINS Server	Type the IP address of the WINS (Windows Internet Naming Service) server that you want to send to the DHCP clients. The WINS server keeps a mapping table of the computer names on your network and the IP addresses that they are currently using.
Lease time	<p>Specify how long each computer can use the information (especially the IP address) before it has to request the information again. Choices are:</p> <p>infinite - select this if IP addresses never expire.</p> <p>days, hours, and minutes - select this to enter how long IP addresses are valid.</p>
Static DHCP Table	Configure a list of static IP addresses the ZyWALL assigns to computers connected to the interface. Otherwise, the ZyWALL assigns an IP address dynamically using the interface's IP Pool Start Address and Pool Size .
Add	Click this to create a new entry.
Edit	Select an entry and click this to be able to modify it.
Remove	Select an entry and click this to delete it.
#	This field is a sequential value, and it is not associated with a specific entry.
IP Address	Enter the IP address to assign to a device with this entry's MAC address.
MAC Address	Enter the MAC address to which to assign this entry's IP address.
Description	Enter a description to help identify this static DHCP entry. You can use alphanumeric and () + / : = ? ! * # @ \$ _ % - characters, and it can be up to 60 characters long.
RIP Setting	See Section 14.2 on page 314 for more information about RIP.
Enable RIP	Select this to enable RIP in this interface.

Table 60 Configuration > Network > Interface > WLAN > Add (No Security)

LABEL	DESCRIPTION
Direction	This field is effective when RIP is enabled. Select the RIP direction from the drop-down list box. BiDir - This interface sends and receives routing information. In-Only - This interface receives routing information. Out-Only - This interface sends routing information.
Send Version	This field is effective when RIP is enabled. Select the RIP version(s) used for sending RIP packets. Choices are 1 , 2 , and 1 and 2 .
Receive Version	This field is effective when RIP is enabled. Select the RIP version(s) used for receiving RIP packets. Choices are 1 , 2 , and 1 and 2 .
V2-Broadcast	This field is effective when RIP is enabled. Select this to send RIP-2 packets using subnet broadcasting; otherwise, the ZyWALL uses multicasting.
OSPF Setting	See Section 14.3 on page 315 for more information about OSPF.
Area	Select the area in which this interface belongs. Select None to disable OSPF in this interface.
Priority	Enter the priority (between 0 and 255) of this interface when the area is looking for a Designated Router (DR) or Backup Designated Router (BDR). The highest-priority interface identifies the DR, and the second-highest-priority interface identifies the BDR. Set the priority to zero if the interface can not be the DR or BDR.
Link Cost	Enter the cost (between 1 and 65,535) to route packets through this interface.
Passive Interface	Select this to stop forwarding OSPF routing information from the selected interface. As a result, this interface only receives routing information.
Authentication	Select an authentication method, or disable authentication. To exchange OSPF routing information with peer border routers, you must use the same authentication method that they use. Choices are: Same-as-Area - use the default authentication method in the area None - disable authentication Text - authenticate OSPF routing information using a plain-text password MD5 - authenticate OSPF routing information using MD5 encryption
Text Authentication Key	This field is available if the Authentication is Text . Type the password for text authentication. The key can consist of alphanumeric characters and the underscore, and it can be up to eight characters long.
MD5 Authentication ID	This field is available if the Authentication is MD5 . Type the ID for MD5 authentication. The ID can be between 1 and 255.
MD5 Authentication Key	This field is available if the Authentication is MD5 . Type the password for MD5 authentication. The password can consist of alphanumeric characters and the underscore, and it can be up to 16 characters long.

Table 60 Configuration > Network > Interface > WLAN > Add (No Security)

LABEL	DESCRIPTION
OK	Click OK to save your changes back to the ZyWALL.
Cancel	Click Cancel to exit this screen without saving.

11.6.2 WLAN Add/Edit: WEP Security

WEP provides a mechanism for encrypting data using encryption keys. Both the ZyWALL and the wireless stations must use the same WEP key to encrypt and decrypt data. Your ZyWALL allows you to configure up to four 64-bit or 128-bit WEP keys, but only one key can be used at any one time.

Note: WEP is extremely insecure. Its encryption can be broken by an attacker, using widely-available software. It is strongly recommended that you use a more effective security mechanism. Use the strongest security mechanism that all the wireless devices in your network support. For example, use WPA-PSK or WPA2-PSK or WPA or WPA2 if your wireless devices support it. If your wireless devices support nothing stronger than WEP, use the highest encryption level available.

To configure and enable WEP encryption, click **Configuration > Network > Interface > WLAN > Add** (or **Edit**) to open the **WLAN Edit** screen. Select **WEP** as the **Security Type**. The following screen shows the WEP security fields.

Figure 170 Configuration > Network > Interface > WLAN > Add (WEP Security)

WLAN Security Settings

Security Type: WEP

802.1x

Radius Server IP Address:

Radius Server Port:

Radius Server Secret:

WEP Encryption: WEP-64

Key 1

Key 2

Key 3

Key 4

The following table describes the WEP-related wireless LAN security labels. See [Table 60 on page 254](#) for information on the 802.1x fields.

Table 61 Configuration > Network > Interface > WLAN > Add (WEP Security)

LABEL	DESCRIPTION
WEP Encryption	WEP (Wired Equivalent Privacy) provides data encryption to prevent unauthorized wireless stations from accessing data transmitted over the wireless network. Select 64-bit WEP or 128-bit WEP to enable data encryption.
Key 1 to Key 4	If you chose 64-bit WEP in the WEP Encryption field, then enter any 5 characters (ASCII string) or 5 pairs of hexadecimal characters ("0-9", "A-F") preceded by 0x for each key. If you chose 128-bit WEP in the WEP Encryption field, then enter 13 characters (ASCII string) or 13 pairs of hexadecimal characters ("0-9", "A-F") preceded by 0x for each key. There are four data encryption keys to secure your data from eavesdropping by unauthorized wireless users. The values for the keys must be set up exactly the same on the access points as they are on the wireless stations.

11.6.3 WLAN Add/Edit: WPA-PSK/WPA2-PSK Security

WPA-PSK or WPA2-PSK security has all of the WLAN interface's users share the same password (pre-shared key).

To configure and enable WPA-PSK or WPA2-PSK security, click **Configuration > Network > Interface > WLAN > Add (or Edit)** to open the **WLAN Edit** screen. Select **WPA-PSK**, **WPA2-PSK**, or **WPA/WPA2-PSK** as the **Security Type**. **WPA/WPA2-PSK** means wireless clients can use either WPA-PSK or WPA2-PSK to connect to the WLAN interface. The following screen shows the security fields.

Figure 171 Configuration > Network > Interface > WLAN > Add (WPA-PSK, WPA2-PSK, or WPA/WPA2-PSK Security)

The screenshot shows the 'WLAN Security Settings' configuration page. It includes the following fields:

- Security Type:** A dropdown menu set to 'WPA2-PSK'.
- Pre Shared Key:** An empty text input field with a red dashed border and a red warning icon to its right.
- ReAuthentication Timer:** A text input field containing '1800' with '(30-30000 seconds)' to its right.
- Idle Timeout:** A text input field containing '3000' with '(30-30000 seconds)' to its right.
- Group Key Update Timer:** A text input field containing '1800' with '(30-30000 seconds)' to its right.

The following table describes the WPA-PSK/WPA2-PSK-related wireless LAN security labels.

Table 62 Configuration > Network > Interface > WLAN > Add (WPA-PSK, WPA2-PSK, or WPA/WPA2-PSK Security)

LABEL	DESCRIPTION
Pre Shared Key	The encryption mechanisms used for WPA and WPA-PSK are the same. The only difference between the two is that WPA-PSK uses a simple common password, instead of user-specific credentials. Type a pre-shared key from 8 to 63 case-sensitive ASCII characters (including spaces and symbols).
ReAuthentication Timer	Specify how often wireless stations have to resend usernames and passwords in order to stay connected. Note: If a RADIUS server authenticates wireless stations, the reauthentication timer on the RADIUS server has priority.
Idle Timeout	The ZyWALL automatically disconnects a wireless station from the wired network after a period of inactivity. The wireless station needs to enter the username and password again before access to the wired network is allowed.
Group Key Update Timer	The Group Key Update Timer is the rate at which the AP sends a new group key out to all clients. The re-keying process is the WPA equivalent of automatically changing the group key for an AP and all stations in a WLAN on a periodic basis. Setting of the Group Key Update Timer is also supported in WPA-PSK mode.

11.6.4 WLAN Add/Edit: WPA/WPA2 Security

With WPA or WPA2 security, each user can have a separate user name and password. The ZyWALL uses an external RADIUS server or the ZyWALL's internal user account list to authenticate the user names and passwords.

To configure and enable WPA or WPA2 security, click **Configuration > Network > Interface > WLAN > Add** (or **Edit**) to open the **WLAN Edit** screen. Select **WPA-Enterprise**, **WPA2-Enterprise**, or **WPA/WPA2-Enterprise** as the **Security Type**. **WPA/WPA2-Enterprise** means wireless clients can use either WPA or WPA2 to connect to the WLAN interface. The following figure shows the security fields.

Figure 172 Configuration > Network > Interface > WLAN > Add (WPA/WPA2 Security)

WLAN Security Settings	
Security Type:	WPA2-Enterprise
Authentication Type:	Auth Server
Radius Server IP Address:	<input type="text"/>
Radius Server Port:	<input type="text"/>
Radius Server Secret:	<input type="text"/>
ReAuthentication Timer:	1800 (30-30000 seconds)
Idle Timeout:	3000 (30-30000 seconds)
Group Key Update Timer:	1800 (30-30000 seconds)

The following table describes the WPA/WPA2-related wireless LAN security labels.

Table 63 Configuration > Network > Interface > WLAN > Add (WPA/WPA2 Security)

LABEL	DESCRIPTION
Authentication Type	<p>Select what the ZyWALL uses to authenticate the wireless clients.</p> <p>Select Auth Method to be able to specify an authentication method object that you have already configured. The authentication method can have the ZyWALL check a user's user name and password against the ZyWALL's local database, a remote LDAP, RADIUS, a Active Directory server, or more than one of these. See Chapter 38 on page 583 for how to create authentication method objects.</p> <p>Select Auth Server to be able to manually specify a RADIUS server's settings in this screen instead of using an authentication method object.</p>
Authentication Method	<p>This field displays if you set the Authentication Type field to Auth Method.</p> <p>Select an authentication method object that defines how the ZyWALL authenticates a wireless user. The ZyWALL's default configuration also includes an authentication method object named "default" that you can use. You can configure the "default" authentication method object, but it's default configuration uses the ZyWALL's local database for authentication.</p>
TTLS Certificate	<p>This field displays if you select Authentication Method. Select the certificate the ZyWALL uses to authenticate itself to the wireless clients. The certificates you can select from are the ones already configured in the My Certificates screen.</p> <p>EAP-TTLS (Tunneled Transport Layer Service) is an extension of the EAP-TLS authentication that uses certificates for only the server-side authentications to establish a secure connection.</p> <p>The wireless clients must use TTLS authentication protocol and PAP inside the TTLS secure tunnel.</p>
	<p>The RADIUS fields display if you set the Authentication Type field to Auth Server.</p>
Radius Server IP Address	<p>Enter the IP address of the external authentication server in dotted decimal notation.</p>

Table 63 Configuration > Network > Interface > WLAN > Add (WPA/WPA2 Security)

LABEL	DESCRIPTION
Radius Server Port	Enter the RADIUS server's listening port number (the default is 1812).
Radius Server Secret	Enter a password (up to 31 alphanumeric characters) as the key to be shared between the external authentication server and the ZyWALL. The key is not sent over the network. This key must be the same on the external authentication server and ZyWALL.
ReAuthentication Timer	Specify how often wireless stations have to resend user names and passwords in order to stay connected. Note: If wireless station authentication is done using a RADIUS server, the reauthentication timer on the RADIUS server has priority.
Idle Timeout	The ZyWALL automatically disconnects a wireless station from the wired network after a period of inactivity. The wireless station needs to enter the user name and password again before access to the wired network is allowed.
Group Key Update Timer	The Group Key Update Timer is the rate at which the AP sends a new group key out to all clients. The re-keying process is the WPA equivalent of automatically changing the group key for an AP and all stations in a WLAN on a periodic basis. Setting of the Group Key Update Timer is also supported in WPA-PSK mode.

11.7 WLAN Interface MAC Filter

This feature is available for USG 20W only.

The MAC filter allows you to give specific wireless clients exclusive access to the ZyWALL (allow association) or block specific devices from accessing the ZyWALL (deny association) based on the devices' MAC addresses.

Every IEEE 802.11b or IEEE 802.11g device has a unique MAC (Media Access Control) address. The MAC address is assigned at the factory and consists of six pairs of hexadecimal characters, for example, 00:A0:C5:00:00:02. You need to know the MAC addresses of the devices to configure this screen.

If you set the filter to deny access and add the MAC address of a connected device, the ZyWALL drops the device's connection immediately. However, if you set the filter to allow only the specified MAC addresses, the ZyWALL does not immediately disconnect all connected wireless clients.

To display your ZyWALL's MAC filter settings, click **Configuration > Network > Interface > WLAN > MAC Filter**. The screen appears as shown.

Figure 173 Network > Interface > WLAN > MAC Filter

The following table describes the labels in this screen.

Table 64 Configuration > Network > Interface > WLAN > MAC Filter

LABEL	DESCRIPTION
Enable MAC Filter	Select or clear the check box to enable or disable MAC address filtering. Enable MAC address filtering to have the router allow or deny access to wireless stations based on MAC addresses. Disable MAC address filtering to have the router not perform MAC filtering on the wireless stations.
Association	Define the filter action for the list of MAC addresses in the MAC address filter table. Select Deny to block access to the router, MAC addresses not listed will be allowed to access the router. Select Allow to permit access to the router, MAC addresses not listed will be denied access to the router.
Add	Click this to add an entry to the table.
Edit	Double-click an entry or select it and click Edit to be able to modify the entry's settings.
Remove	To remove an entry, select it and click Remove . The ZyWALL confirms you want to remove it before doing so.
#	This is the index number of the MAC address.
MAC Address	This displays the MAC address (in XX:XX:XX:XX:XX:XX format) of the wireless station that is allowed or denied access to the ZyWALL. Enter the MAC address (in XX:XX:XX:XX:XX:XX or XX-XX-XX-XX-XX-XX format) of the wireless station that is to be allowed or denied access to the ZyWALL. Note that if you enter the MAC address using hyphens for the separators, the ZyWALL automatically converts them to colons.
Description	This field displays a descriptive name for the MAC address entry. Enter a descriptive name for the MAC address entry.
Apply	Click Apply to save your changes back to the ZyWALL.
Reset	Click Reset to return the screen to its last-saved settings.

11.8 VLAN Interfaces

A Virtual Local Area Network (VLAN) divides a physical network into multiple logical networks. The standard is defined in IEEE 802.1q.

Figure 174 Example: Before VLAN

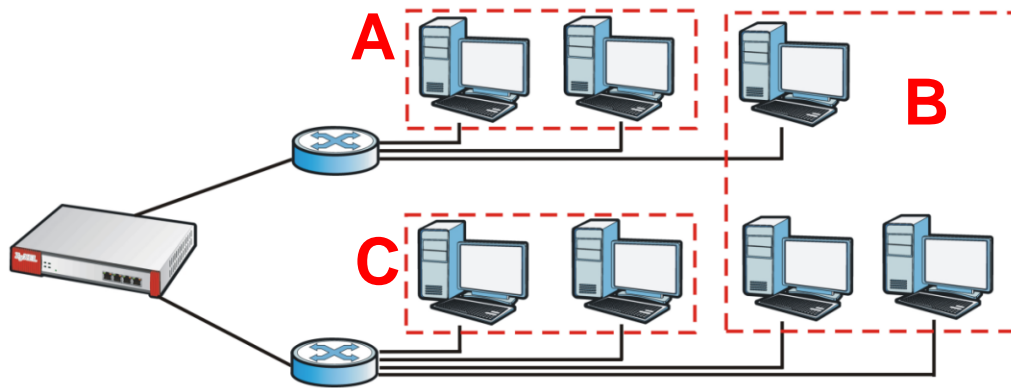

In this example, there are two physical networks and three departments **A**, **B**, and **C**. The physical networks are connected to hubs, and the hubs are connected to the router.

Alternatively, you can divide the physical networks into three VLANs.

Figure 175 Example: After VLAN

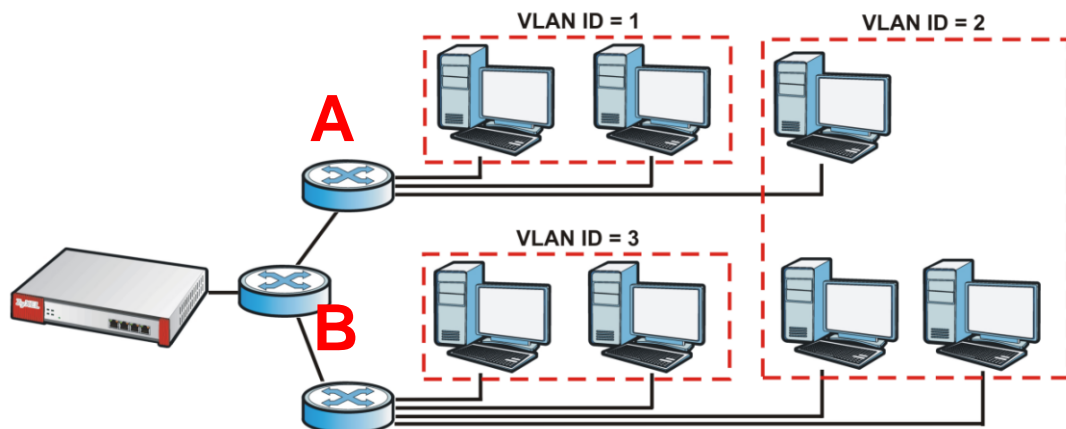

Each VLAN is a separate network with separate IP addresses, subnet masks, and gateways. Each VLAN also has a unique identification number (ID). The ID is a 12-bit value that is stored in the MAC header. The VLANs are connected to switches, and the switches are connected to the router. (If one switch has enough connections for the entire network, the network does not need switches **A** and **B**.)

- Traffic inside each VLAN is layer-2 communication (data link layer, MAC addresses). It is handled by the switches. As a result, the new switch is required to handle traffic inside VLAN 2. Traffic is only broadcast inside each VLAN, not each physical network.
- Traffic between VLANs (or between a VLAN and another type of network) is layer-3 communication (network layer, IP addresses). It is handled by the router.

This approach provides a few advantages.

- Increased performance - In VLAN 2, the extra switch should route traffic inside the sales department faster than the router does. In addition, broadcasts are limited to smaller, more logical groups of users.
- Higher security - If each computer has a separate physical connection to the switch, then broadcast traffic in each VLAN is never sent to computers in another VLAN.
- Better manageability - You can align network policies more appropriately for users. For example, you can create different content filtering rules for each VLAN (each department in the example above), and you can set different bandwidth limits for each VLAN. These rules are also independent of the physical network, so you can change the physical network without changing policies.

In this example, the new switch handles the following types of traffic:

- Inside VLAN 2.
- Between the router and VLAN 1.
- Between the router and VLAN 2.
- Between the router and VLAN 3.

VLAN Interfaces Overview

In the ZyWALL, each VLAN is called a VLAN interface. As a router, the ZyWALL routes traffic between VLAN interfaces, but it does not route traffic within a VLAN interface. All traffic for each VLAN interface can go through only one Ethernet interface, though each Ethernet interface can have one or more VLAN interfaces.

Note: Each VLAN interface is created on top of only one Ethernet interface.

Otherwise, VLAN interfaces are similar to other interfaces in many ways. They have an IP address, subnet mask, and gateway used to make routing decisions. They restrict bandwidth and packet size. They can provide DHCP services, and they can verify the gateway is available.

11.8.1 VLAN Summary Screen

This screen lists every VLAN interface and virtual interface created on top of VLAN interfaces. To access this screen, click **Configuration > Network > Interface > VLAN**.

Figure 176 Configuration > Network > Interface > VLAN

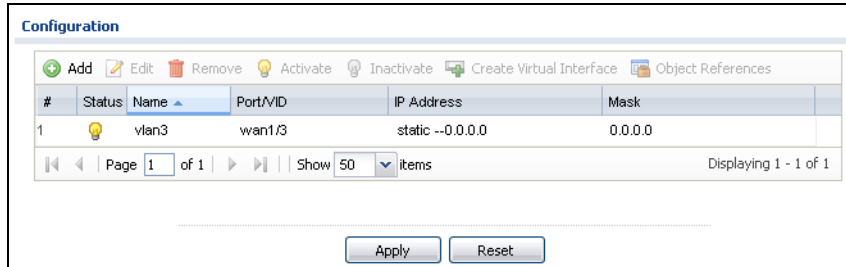

Each field is explained in the following table.

Table 65 Configuration > Network > Interface > VLAN

LABEL	DESCRIPTION
Edit	Double-click an entry or select it and click Edit to open a screen where you can modify the entry's settings.
Remove	To remove an entry, select it and click Remove . The ZyWALL confirms you want to remove it before doing so.
Activate	To turn on an entry, select it and click Activate .
Inactivate	To turn off an entry, select it and click Inactivate .
Create Virtual Interface	To open the screen where you can create a virtual interface, select an interface and click Create Virtual Interface .
Object References	Select an entry and click Object References to open a screen that shows which settings use the entry. See Section 11.3.2 on page 232 for an example.
#	This field is a sequential value, and it is not associated with any interface.
Status	This icon is lit when the entry is active and dimmed when the entry is inactive.
Name	This field displays the name of the interface.
Port/VID	For VLAN interfaces, this field displays <ul style="list-style-type: none"> the Ethernet interface on which the VLAN interface is created the VLAN ID For virtual interfaces, this field is blank.
IP Address	This field displays the current IP address of the interface. If the IP address is 0.0.0.0, the interface does not have an IP address yet. This screen also shows whether the IP address is a static IP address (STATIC) or dynamically assigned (DHCP). IP addresses are always static in virtual interfaces.
Mask	This field displays the interface's subnet mask in dot decimal notation.

Table 65 Configuration > Network > Interface > VLAN (continued)

LABEL	DESCRIPTION
Apply	Click Apply to save your changes back to the ZyWALL.
Reset	Click Reset to return the screen to its last-saved settings.

11.8.2 VLAN Add/Edit

This screen lets you configure IP address assignment, interface bandwidth parameters, DHCP settings, and connectivity check for each VLAN interface. To access this screen, click the **Add** icon at the top of the **Add** column or click an **Edit** icon next to a VLAN interface in the **VLAN Summary** screen. The following screen appears.

Figure 177 Configuration > Network > Interface > VLAN > Edit

Add VLAN [?] [X]

Hide Advanced Settings

General Settings

Enable Interface

Interface Properties

Interface Name: ⓘ

Zone:

Base Port:

VLAN ID: ⓘ

Description: (Optional)

IP Address Assignment

Get Automatically

Use Fixed IP Address

IP Address:

Subnet Mask:

Gateway: (Optional)

Metric: (0-15)

Interface Parameters

Egress Bandwidth: Kbps

Ingress Bandwidth: Kbps

MTU: Bytes

Connectivity Check

Enable Connectivity Check

Check Method:

Check Period: (5-30 seconds)

Check Timeout: (1-10 seconds)

Check Fail Tolerance: (1-10)

Check Default Gateway
0.0.0.0

Check this address: (Domain Name or IP Address)

DHCP Setting

DHCP:

Enable IP/MAC Binding

Enable Logs for IP/MAC Binding Violation

Static DHCP Table

#	IP Address	MAC	Description
No data to display			

RIP Setting

Enable RIP

Direction:

Send Version:

Receive Version:

V2-Broadcast

OSPF Setting

Area:

Priority: (0-255)

Link Cost: (1-65535)

Passive Interface

Authentication:

Related Setting

[Configure WAN TRUNK](#)

[Configure Policy Route](#)

Each field is explained in the following table.

Table 66 Configuration > Network > Interface > VLAN > Edit

LABEL	DESCRIPTION
Show Advance Settings / Hide Advance Settings	Click this button to display a greater or lesser number of configuration fields.
General Settings	
Enable Interface	Select this to turn this interface on. Clear this to disable this interface.
Interface Properties	
Interface Name	This field is read-only if you are editing an existing VLAN interface. Enter the number of the VLAN interface. You can use a number from 0~4094. See Chapter 51 on page 741 the User's Guide for the total number of VLANs you can configure on the ZyWALL. For example, vlan0, vlan8, and so on.
Zone	Select the zone to which the VLAN interface belongs.
Base Port	Select the Ethernet interface on which the VLAN interface runs.
VLAN ID	Enter the VLAN ID. This 12-bit number uniquely identifies each VLAN. Allowed values are 1 - 4094. (0 and 4095 are reserved.)
Description	Enter a description of this interface. It is not used elsewhere. You can use alphanumeric and () + / : = ? ! * # @ \$ _ % - characters, and it can be up to 60 characters long.
IP Address Assignment	
Get Automatically	Select this if this interface is a DHCP client. In this case, the DHCP server configures the IP address, subnet mask, and gateway automatically. You should not select this if the interface is assigned to a VRRP group. See Chapter 39 on page 715 .
Use Fixed IP Address	Select this if you want to specify the IP address, subnet mask, and gateway manually.
IP Address	This field is enabled if you select Use Fixed IP Address . Enter the IP address for this interface.
Subnet Mask	This field is enabled if you select Use Fixed IP Address . Enter the subnet mask of this interface in dot decimal notation. The subnet mask indicates what part of the IP address is the same for all computers in the network.
Gateway	This field is enabled if you select Use Fixed IP Address . Enter the IP address of the gateway. The ZyWALL sends packets to the gateway when it does not know how to route the packet to its destination. The gateway should be on the same network as the interface.

Table 66 Configuration > Network > Interface > VLAN > Edit (continued)

LABEL	DESCRIPTION
Metric	Enter the priority of the gateway (if any) on this interface. The ZyWALL decides which gateway to use based on this priority. The lower the number, the higher the priority. If two or more gateways have the same priority, the ZyWALL uses the one that was configured first.
Interface Parameters	
Egress Bandwidth	Enter the maximum amount of traffic, in kilobits per second, the ZyWALL can send through the interface to the network. Allowed values are 0 - 1048576.
Ingress Bandwidth	This is reserved for future use. Enter the maximum amount of traffic, in kilobits per second, the ZyWALL can receive from the network through the interface. Allowed values are 0 - 1048576.
MTU	Maximum Transmission Unit. Type the maximum size of each data packet, in bytes, that can move through this interface. If a larger packet arrives, the ZyWALL divides it into smaller fragments. Allowed values are 576 - 1500. Usually, this value is 1500.
Connectivity Check	The ZyWALL can regularly check the connection to the gateway you specified to make sure it is still available. You specify how often to check the connection, how long to wait for a response before the attempt is a failure, and how many consecutive failures are required before the ZyWALL stops routing to the gateway. The ZyWALL resumes routing to the gateway the first time the gateway passes the connectivity check.
Enable Connectivity Check	Select this to turn on the connection check.
Check Method	Select the method that the gateway allows. Select icmp to have the ZyWALL regularly ping the gateway you specify to make sure it is still available. Select tcp to have the ZyWALL regularly perform a TCP handshake with the gateway you specify to make sure it is still available.
Check Period	Enter the number of seconds between connection check attempts.
Check Timeout	Enter the number of seconds to wait for a response before the attempt is a failure.
Check Fail Tolerance	Enter the number of consecutive failures before the ZyWALL stops routing through the gateway.
Check Default Gateway	Select this to use the default gateway for the connectivity check.
Check this address	Select this to specify a domain name or IP address for the connectivity check. Enter that domain name or IP address in the field next to it.
Check Port	This field only displays when you set the Check Method to tcp . Specify the port number to use for a TCP connectivity check.
DHCP Setting	The DHCP settings are available for the OPT, LAN and DMZ interfaces.

Table 66 Configuration > Network > Interface > VLAN > Edit (continued)

LABEL	DESCRIPTION
DHCP	<p>Select what type of DHCP service the ZyWALL provides to the network. Choices are:</p> <p>None - the ZyWALL does not provide any DHCP services. There is already a DHCP server on the network.</p> <p>DHCP Relay - the ZyWALL routes DHCP requests to one or more DHCP servers you specify. The DHCP server(s) may be on another network.</p> <p>DHCP Server - the ZyWALL assigns IP addresses and provides subnet mask, gateway, and DNS server information to the network. The ZyWALL is the DHCP server for the network.</p>
	These fields appear if the ZyWALL is a DHCP Relay .
Relay Server 1	Enter the IP address of a DHCP server for the network.
Relay Server 2	This field is optional. Enter the IP address of another DHCP server for the network.
	These fields appear if the ZyWALL is a DHCP Server .
IP Pool Start Address	<p>Enter the IP address from which the ZyWALL begins allocating IP addresses. If you want to assign a static IP address to a specific computer, click Add Static DHCP.</p> <p>If this field is blank, the Pool Size must also be blank. In this case, the ZyWALL can assign every IP address allowed by the interface's IP address and subnet mask, except for the first address (network address), last address (broadcast address) and the interface's IP address.</p>
Pool Size	<p>Enter the number of IP addresses to allocate. This number must be at least one and is limited by the interface's Subnet Mask. For example, if the Subnet Mask is 255.255.255.0 and IP Pool Start Address is 10.10.10.10, the ZyWALL can allocate 10.10.10.10 to 10.10.10.254, or 245 IP addresses.</p> <p>If this field is blank, the IP Pool Start Address must also be blank. In this case, the ZyWALL can assign every IP address allowed by the interface's IP address and subnet mask, except for the first address (network address), last address (broadcast address) and the interface's IP address.</p>
First DNS Server Second DNS Server Third DNS Server	<p>Specify the IP addresses up to three DNS servers for the DHCP clients to use. Use one of the following ways to specify these IP addresses.</p> <p>Custom Defined - enter a static IP address.</p> <p>From ISP - select the DNS server that another interface received from its DHCP server.</p> <p>ZyWALL - the DHCP clients use the IP address of this interface and the ZyWALL works as a DNS relay.</p>
First WINS Server, Second WINS Server	Type the IP address of the WINS (Windows Internet Naming Service) server that you want to send to the DHCP clients. The WINS server keeps a mapping table of the computer names on your network and the IP addresses that they are currently using.

Table 66 Configuration > Network > Interface > VLAN > Edit (continued)

LABEL	DESCRIPTION
Lease time	Specify how long each computer can use the information (especially the IP address) before it has to request the information again. Choices are: infinite - select this if IP addresses never expire days, hours, and minutes - select this to enter how long IP addresses are valid.
Enable IP/MAC Binding	Select this option to have the ZyWALL enforce links between specific IP addresses and specific MAC addresses for this VLAN. This stops anyone else from manually using a bound IP address on another device connected to this interface. Use this to make use only the intended users get to use specific IP addresses.
Enable Logs for IP/MAC Binding Violation	Select this option to have the ZyWALL generate a log if a device connected to this VLAN attempts to use an IP address that is bound to another device's MAC address.
Static DHCP Table	Configure a list of static IP addresses the ZyWALL assigns to computers connected to the interface. Otherwise, the ZyWALL assigns an IP address dynamically using the interface's IP Pool Start Address and Pool Size .
Add	Click this to create a new entry.
Edit	Select an entry and click this to be able to modify it.
Remove	Select an entry and click this to delete it.
#	This field is a sequential value, and it is not associated with a specific entry.
IP Address	Enter the IP address to assign to a device with this entry's MAC address.
MAC Address	Enter the MAC address to which to assign this entry's IP address.
Description	Enter a description to help identify this static DHCP entry. You can use alphanumeric and () + / : = ? ! * # @ \$ _ % - characters, and it can be up to 60 characters long.
RIP Setting	See Section 14.2 on page 314 for more information about RIP.
Enable RIP	Select this to enable RIP on this interface.
Direction	This field is effective when RIP is enabled. Select the RIP direction from the drop-down list box. BiDir - This interface sends and receives routing information. In-Only - This interface receives routing information. Out-Only - This interface sends routing information.
Send Version	This field is effective when RIP is enabled. Select the RIP version(s) used for sending RIP packets. Choices are 1 , 2 , and 1 and 2 .
Receive Version	This field is effective when RIP is enabled. Select the RIP version(s) used for receiving RIP packets. Choices are 1 , 2 , and 1 and 2 .
V2-Broadcast	This field is effective when RIP is enabled. Select this to send RIP-2 packets using subnet broadcasting; otherwise, the ZyWALL uses multicasting.

Table 66 Configuration > Network > Interface > VLAN > Edit (continued)

LABEL	DESCRIPTION
OSPF Setting	See Section 14.3 on page 315 for more information about OSPF.
Area	Select the area in which this interface belongs. Select None to disable OSPF in this interface.
Priority	Enter the priority (between 0 and 255) of this interface when the area is looking for a Designated Router (DR) or Backup Designated Router (BDR). The highest-priority interface identifies the DR, and the second-highest-priority interface identifies the BDR. Set the priority to zero if the interface can not be the DR or BDR.
Link Cost	Enter the cost (between 1 and 65,535) to route packets through this interface.
Passive Interface	Select this to stop forwarding OSPF routing information from the selected interface. As a result, this interface only receives routing information.
Authentication	Select an authentication method, or disable authentication. To exchange OSPF routing information with peer border routers, you must use the same authentication method that they use. Choices are: Same-as-Area - use the default authentication method in the area None - disable authentication Text - authenticate OSPF routing information using a plain-text password MD5 - authenticate OSPF routing information using MD5 encryption
Text Authentication Key	This field is available if the Authentication is Text . Type the password for text authentication. The key can consist of alphanumeric characters and the underscore, and it can be up to 16 characters long.
MD5 Authentication ID	This field is available if the Authentication is MD5 . Type the ID for MD5 authentication. The ID can be between 1 and 255.
MD5 Authentication Key	This field is available if the Authentication is MD5 . Type the password for MD5 authentication. The password can consist of alphanumeric characters and the underscore, and it can be up to 16 characters long.
Related Setting	
Configure WAN TRUNK	Click WAN TRUNK to go to a screen where you can set this VLAN to be part of a WAN trunk for load balancing.
Configure Policy Route	Click Policy Route to go to the screen where you can manually configure a policy route to associate traffic with this VLAN.
OK	Click OK to save your changes back to the ZyWALL.
Cancel	Click Cancel to exit this screen without saving.

11.9 Bridge Interfaces

This section introduces bridges and bridge interfaces and then explains the screens for bridge interfaces.

Bridge Overview

A bridge creates a connection between two or more network segments at the layer-2 (MAC address) level. In the following example, bridge X connects four network segments.

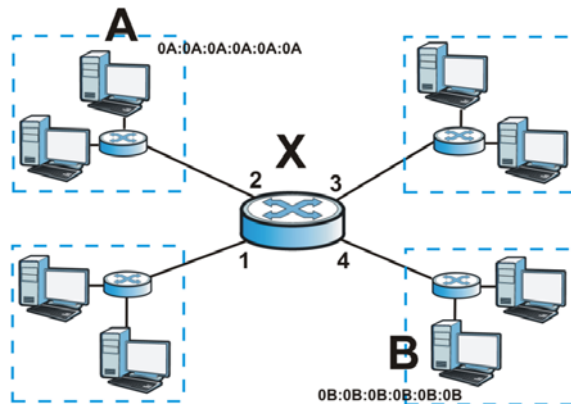

When the bridge receives a packet, the bridge records the source MAC address and the port on which it was received in a table. It also looks up the destination MAC address in the table. If the bridge knows on which port the destination MAC address is located, it sends the packet to that port. If the destination MAC address is not in the table, the bridge broadcasts the packet on every port (except the one on which it was received).

In the example above, computer A sends a packet to computer B. Bridge X records the source address 0A:0A:0A:0A:0A:0A and port 2 in the table. It also looks up 0B:0B:0B:0B:0B:0B in the table. There is no entry yet, so the bridge broadcasts the packet on ports 1, 3, and 4.

Table 67 Example: Bridge Table After Computer A Sends a Packet to Computer B

MAC ADDRESS	PORT
0A:0A:0A:0A:0A:0A	2

If computer B responds to computer A, bridge X records the source address 0B:0B:0B:0B:0B:0B and port 4 in the table. It also looks up 0A:0A:0A:0A:0A:0A in the table and sends the packet to port 2 accordingly.

Table 68 Example: Bridge Table After Computer B Responds to Computer A

MAC ADDRESS	PORT
0A:0A:0A:0A:0A:0A	2
0B:0B:0B:0B:0B:0B	4

Bridge Interface Overview

A bridge interface creates a software bridge between the members of the bridge interface. It also becomes the ZyWALL's interface for the resulting network.

Unlike the device-wide bridge mode in ZyNOS-based ZyWALLs, this ZyWALL can bridge traffic between some interfaces while it routes traffic for other interfaces. The bridge interfaces also support more functions, like interface bandwidth parameters, DHCP settings, and connectivity check. To use the whole ZyWALL as a transparent bridge, add all of the ZyWALL's interfaces to a bridge interface.

A bridge interface may consist of the following members:

- Zero or one WLAN interfaces
- Zero or one VLAN interfaces (and any associated virtual VLAN interfaces)
- Any number of Ethernet interfaces (and any associated virtual Ethernet interfaces)

When you create a bridge interface, the ZyWALL removes the members' entries from the routing table and adds the bridge interface's entries to the routing table. For example, this table shows the routing table before and after you create bridge interface br0 (250.250.250.0/23) between lan1 and vlan1.

Table 69 Example: Routing Table Before and After Bridge Interface br0 Is Created

IP ADDRESS(ES)	DESTINATION	IP ADDRESS(ES)	DESTINATION
210.210.210.0/24	lan1	221.221.221.0/24	vlan0
210.211.1.0/24	lan1:1	230.230.230.192/26	wan
221.221.221.0/24	vlan0	241.241.241.241/32	dmz
222.222.222.0/24	vlan1	242.242.242.242/32	dmz
230.230.230.192/26	wan	250.250.250.0/23	br0
241.241.241.241/32	dmz		
242.242.242.242/32	dmz		

In this example, virtual Ethernet interface lan1:1 is also removed from the routing table when lan1 is added to br0. Virtual interfaces are automatically added to or

remove from a bridge interface when the underlying interface is added or removed.

11.9.1 Bridge Summary

This screen lists every bridge interface and virtual interface created on top of bridge interfaces. To access this screen, click **Configuration > Network > Interface > Bridge**.

Figure 178 Configuration > Network > Interface > Bridge

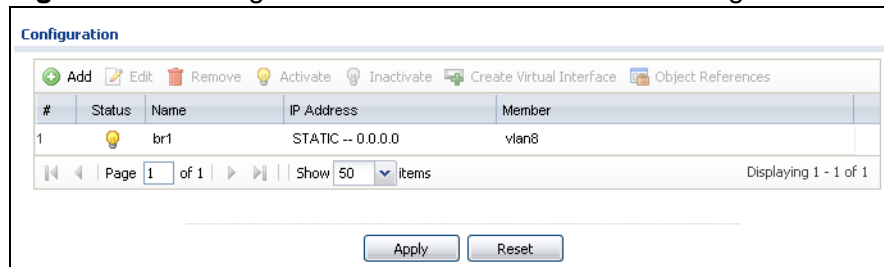

Each field is described in the following table.

Table 70 Configuration > Network > Interface > Bridge

LABEL	DESCRIPTION
Add	Click this to create a new entry.
Edit	Double-click an entry or select it and click Edit to open a screen where you can modify the entry's settings.
Remove	To remove an entry, select it and click Remove . The ZyWALL confirms you want to remove it before doing so.
Activate	To turn on an entry, select it and click Activate .
Inactivate	To turn off an entry, select it and click Inactivate .
Create Virtual Interface	To open the screen where you can create a virtual interface, select an interface and click Create Virtual Interface .
Object References	Select an entry and click Object References to open a screen that shows which settings use the entry. See Section 11.3.2 on page 232 for an example.
#	This field is a sequential value, and it is not associated with any interface.
Status	This icon is lit when the entry is active and dimmed when the entry is inactive.
Name	This field displays the name of the interface.
IP Address	This field displays the current IP address of the interface. If the IP address is 0.0.0.0, the interface does not have an IP address yet. This screen also shows whether the IP address is a static IP address (STATIC) or dynamically assigned (DHCP). IP addresses are always static in virtual interfaces.
Member	This field displays the Ethernet interfaces and VLAN interfaces in the bridge interface. It is blank for virtual interfaces.

Table 70 Configuration > Network > Interface > Bridge (continued)

LABEL	DESCRIPTION
Apply	Click Apply to save your changes back to the ZyWALL.
Reset	Click Reset to return the screen to its last-saved settings.

11.9.2 Bridge Add/Edit

This screen lets you configure IP address assignment, interface bandwidth parameters, DHCP settings, and connectivity check for each bridge interface. To access this screen, click the **Add** icon at the top of the **Add** column in the **Bridge Summary** screen, or click an **Edit** icon in the **Bridge Summary** screen. The following screen appears.

Figure 179 Configuration > Network > Interface > Bridge > Add

General Settings

Enable Interface

Interface Properties

Interface Name: !

Zone:

Description: (Optional)

Member Configuration

Available

- vlan1
- vlan2
- vlan4
- vlan5
- vlan6
- vlan7
- wlan-2-1
- wlan-1-2
- wlan-2-2

Member

- vlan8

IP Address Assignment

Get Automatically

Use Fixed IP Address

IP Address:

Subnet Mask:

Gateway: (Optional)

Metric: (0-15)

Related Setting

[Configure WAN TRUNK](#)

[Configure Policy Route](#)

Interface Parameters

Egress Bandwidth: Kbps

Ingress Bandwidth: Kbps

MTU: Bytes

DHCP Setting

DHCP:

IP Pool Start Address (Optional):

Pool Size:

First DNS Server (Optional):

Second DNS server (Optional):

Third DNS Server (Optional):

First WINS Server (Optional):

Second WINS Server (Optional):

Lease time:

infinite

3 days 0 hours (Optional) 0 minutes (Optional)

Enable IP/MAC Binding

Enable Logs for IP/MAC Binding Violation

Static DHCP Table

#	IP Address	MAC	Description
1			

Page 1 of 1 | Show 50 items | No data to display

Connectivity Check

Enable Connectivity Check

Check Method:

Check Period: (5-30 seconds)

Check Timeout: (1-10 seconds)

Check Fail Tolerance: (1-10)

Check Default Gateway:

Check this address: (Domain Name or IP Address)

OK Cancel

Each field is described in the table below.

Table 71 Configuration > Network > Interface > Bridge > Edit

LABEL	DESCRIPTION
Show Advance Settings / Hide Advance Settings	Click this button to display a greater or lesser number of configuration fields.
General Settings	
Enable Interface	Select this to enable this interface. Clear this to disable this interface.
Interface Properties	
Interface Name	This field is read-only if you are editing the interface. Enter the name of the bridge interface. The format is brx, where x is 0 - 11. For example, br0, br3, and so on.
Zone	Select the zone to which the interface is to belong. You use zones to apply security settings such as firewall, remote management.
Description	Enter a description of this interface. It is not used elsewhere. You can use alphanumeric and () + / : = ? ! * # @ \$ _ % - characters, and it can be up to 60 characters long.
Member Configuration	
Available	This field displays Ethernet interfaces and VLAN interfaces that can become part of the bridge interface. An interface is not available in the following situations: <ul style="list-style-type: none"> • There is a virtual interface on top of it • It is already used in a different bridge interface Select one, and click the >> arrow to add it to the bridge interface. Each bridge interface can only have one VLAN interface.
Member	This field displays the interfaces that are part of the bridge interface. Select one, and click the << arrow to remove it from the bridge interface.
IP Address Assignment	
Get Automatically	Select this if this interface is a DHCP client. In this case, the DHCP server configures the IP address, subnet mask, and gateway automatically.
Use Fixed IP Address	Select this if you want to specify the IP address, subnet mask, and gateway manually.
IP Address	This field is enabled if you select Use Fixed IP Address . Enter the IP address for this interface.
Subnet Mask	This field is enabled if you select Use Fixed IP Address . Enter the subnet mask of this interface in dot decimal notation. The subnet mask indicates what part of the IP address is the same for all computers in the network.

Table 71 Configuration > Network > Interface > Bridge > Edit (continued)

LABEL	DESCRIPTION
Gateway	This field is enabled if you select Use Fixed IP Address . Enter the IP address of the gateway. The ZyWALL sends packets to the gateway when it does not know how to route the packet to its destination. The gateway should be on the same network as the interface.
Metric	Enter the priority of the gateway (if any) on this interface. The ZyWALL decides which gateway to use based on this priority. The lower the number, the higher the priority. If two or more gateways have the same priority, the ZyWALL uses the one that was configured first.
Related Setting	
Configure WAN TRUNK	Click WAN TRUNK to go to a screen where you can configure the interface as part of a WAN trunk for load balancing.
Configure Policy Route	Click Policy Route to go to the screen where you can manually configure a policy route to associate traffic with this bridge interface.
Interface Parameters	
Egress Bandwidth	Enter the maximum amount of traffic, in kilobits per second, the ZyWALL can send through the interface to the network. Allowed values are 0 - 1048576.
Ingress Bandwidth	This is reserved for future use. Enter the maximum amount of traffic, in kilobits per second, the ZyWALL can receive from the network through the interface. Allowed values are 0 - 1048576.
MTU	Maximum Transmission Unit. Type the maximum size of each data packet, in bytes, that can move through this interface. If a larger packet arrives, the ZyWALL divides it into smaller fragments. Allowed values are 576 - 1500. Usually, this value is 1500.
DHCP Setting	
DHCP	Select what type of DHCP service the ZyWALL provides to the network. Choices are: None - the ZyWALL does not provide any DHCP services. There is already a DHCP server on the network. DHCP Relay - the ZyWALL routes DHCP requests to one or more DHCP servers you specify. The DHCP server(s) may be on another network. DHCP Server - the ZyWALL assigns IP addresses and provides subnet mask, gateway, and DNS server information to the network. The ZyWALL is the DHCP server for the network.
	These fields appear if the ZyWALL is a DHCP Relay .
Relay Server 1	Enter the IP address of a DHCP server for the network.
Relay Server 2	This field is optional. Enter the IP address of another DHCP server for the network.
	These fields appear if the ZyWALL is a DHCP Server .

Table 71 Configuration > Network > Interface > Bridge > Edit (continued)

LABEL	DESCRIPTION
IP Pool Start Address	<p>Enter the IP address from which the ZyWALL begins allocating IP addresses. If you want to assign a static IP address to a specific computer, click Add Static DHCP.</p> <p>If this field is blank, the Pool Size must also be blank. In this case, the ZyWALL can assign every IP address allowed by the interface's IP address and subnet mask, except for the first address (network address), last address (broadcast address) and the interface's IP address.</p>
Pool Size	<p>Enter the number of IP addresses to allocate. This number must be at least one and is limited by the interface's Subnet Mask. For example, if the Subnet Mask is 255.255.255.0 and IP Pool Start Address is 10.10.10.10, the ZyWALL can allocate 10.10.10.10 to 10.10.10.254, or 245 IP addresses.</p> <p>If this field is blank, the IP Pool Start Address must also be blank. In this case, the ZyWALL can assign every IP address allowed by the interface's IP address and subnet mask, except for the first address (network address), last address (broadcast address) and the interface's IP address.</p>
First DNS Server Second DNS Server Third DNS Server	<p>Specify the IP addresses up to three DNS servers for the DHCP clients to use. Use one of the following ways to specify these IP addresses.</p> <p>Custom Defined - enter a static IP address.</p> <p>From ISP - select the DNS server that another interface received from its DHCP server.</p> <p>ZyWALL - the DHCP clients use the IP address of this interface and the ZyWALL works as a DNS relay.</p>
First WINS Server, Second WINS Server	<p>Type the IP address of the WINS (Windows Internet Naming Service) server that you want to send to the DHCP clients. The WINS server keeps a mapping table of the computer names on your network and the IP addresses that they are currently using.</p>
Lease time	<p>Specify how long each computer can use the information (especially the IP address) before it has to request the information again. Choices are:</p> <p>infinite - select this if IP addresses never expire</p> <p>days, hours, and minutes - select this to enter how long IP addresses are valid.</p>
Enable IP/MAC Binding	<p>Select this option to have this interface enforce links between specific IP addresses and specific MAC addresses. This stops anyone else from manually using a bound IP address on another device connected to this interface. Use this to make use only the intended users get to use specific IP addresses.</p>
Enable Logs for IP/MAC Binding Violation	<p>Select this option to have the ZyWALL generate a log if a device connected to this interface attempts to use an IP address that is bound to another device's MAC address.</p>
Static DHCP Table	<p>Configure a list of static IP addresses the ZyWALL assigns to computers connected to the interface. Otherwise, the ZyWALL assigns an IP address dynamically using the interface's IP Pool Start Address and Pool Size.</p>

Table 71 Configuration > Network > Interface > Bridge > Edit (continued)

LABEL	DESCRIPTION
Add	Click this to create a new entry.
Edit	Select an entry and click this to be able to modify it.
Remove	Select an entry and click this to delete it.
#	This field is a sequential value, and it is not associated with a specific entry.
IP Address	Enter the IP address to assign to a device with this entry's MAC address.
MAC Address	Enter the MAC address to which to assign this entry's IP address.
Description	Enter a description to help identify this static DHCP entry. You can use alphanumeric and () + / : = ? ! * # @ \$ _ % - characters, and it can be up to 60 characters long.
Connectivity Check	The interface can regularly check the connection to the gateway you specified to make sure it is still available. You specify how often the interface checks the connection, how long to wait for a response before the attempt is a failure, and how many consecutive failures are required before the ZyWALL stops routing to the gateway. The ZyWALL resumes routing to the gateway the first time the gateway passes the connectivity check.
Enable Connectivity Check	Select this to turn on the connection check.
Check Method	Select the method that the gateway allows. Select icmp to have the ZyWALL regularly ping the gateway you specify to make sure it is still available. Select tcp to have the ZyWALL regularly perform a TCP handshake with the gateway you specify to make sure it is still available.
Check Period	Enter the number of seconds between connection check attempts.
Check Timeout	Enter the number of seconds to wait for a response before the attempt is a failure.
Check Fail Tolerance	Enter the number of consecutive failures before the ZyWALL stops routing through the gateway.
Check Default Gateway	Select this to use the default gateway for the connectivity check.
Check this address	Select this to specify a domain name or IP address for the connectivity check. Enter that domain name or IP address in the field next to it.
Check Port	This field only displays when you set the Check Method to tcp . Specify the port number to use for a TCP connectivity check.
OK	Click OK to save your changes back to the ZyWALL.
Cancel	Click Cancel to exit this screen without saving.

11.9.3 Virtual Interfaces Add/Edit

This screen lets you configure IP address assignment and interface parameters for virtual interfaces. To access this screen, click an **Add** icon next to an Ethernet

interface, VLAN interface, or bridge interface in the respective interface summary screen.

Figure 180 Configuration > Network > Interface > Add

Each field is described in the table below.

Table 72 Configuration > Network > Interface > Add

LABEL	DESCRIPTION
Interface Properties	
Interface Name	This field is read-only. It displays the name of the virtual interface, which is automatically derived from the underlying Ethernet interface, VLAN interface, or bridge interface.
Description	Enter a description of this interface. It is not used elsewhere. You can use alphanumeric and () + / : = ? ! * # @ \$ _ % - characters, and it can be up to 60 characters long.
IP Address Assignment	
IP Address	Enter the IP address for this interface.
Subnet Mask	Enter the subnet mask of this interface in dot decimal notation. The subnet mask indicates what part of the IP address is the same for all computers in the network.
Gateway	Enter the IP address of the gateway. The ZyWALL sends packets to the gateway when it does not know how to route the packet to its destination. The gateway should be on the same network as the interface.
Metric	Enter the priority of the gateway (if any) on this interface. The ZyWALL decides which gateway to use based on this priority. The lower the number, the higher the priority. If two or more gateways have the same priority, the ZyWALL uses the one that was configured first.
Interface Parameters	

Table 72 Configuration > Network > Interface > Add (continued)

LABEL	DESCRIPTION
Egress Bandwidth	Enter the maximum amount of traffic, in kilobits per second, the ZyWALL can send through the interface to the network. Allowed values are 0 - 1048576.
Ingress Bandwidth	This is reserved for future use. Enter the maximum amount of traffic, in kilobits per second, the ZyWALL can receive from the network through the interface. Allowed values are 0 - 1048576.
OK	Click OK to save your changes back to the ZyWALL.
Cancel	Click Cancel to exit this screen without saving.

11.10 Interface Technical Reference

Here is more detailed information about interfaces on the ZyWALL.

IP Address Assignment

Most interfaces have an IP address and a subnet mask. This information is used to create an entry in the routing table.

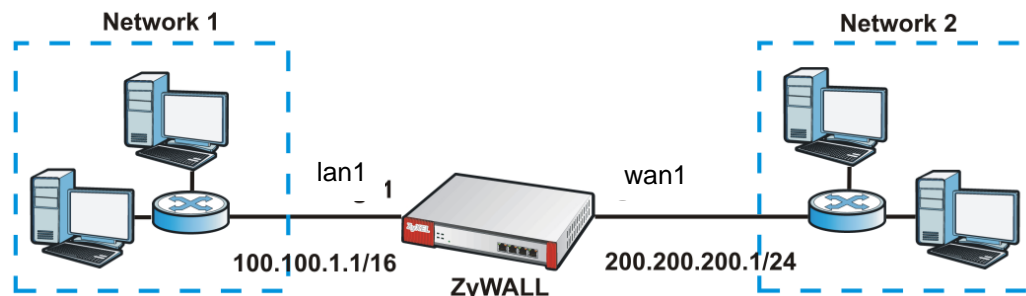
Figure 181 Example: Entry in the Routing Table Derived from Interfaces**Table 73** Example: Routing Table Entries for Interfaces

IP ADDRESS(ES)	DESTINATION
100.100.1.1/16	lan1
200.200.200.1/24	wan1

For example, if the ZyWALL gets a packet with a destination address of 100.100.25.25, it routes the packet to interface lan1. If the ZyWALL gets a packet with a destination address of 200.200.200.200, it routes the packet to interface wan1.

In most interfaces, you can enter the IP address and subnet mask manually. In PPPoE/PPTP interfaces, however, the subnet mask is always 255.255.255.255

because it is a point-to-point interface. For these interfaces, you can only enter the IP address.

In many interfaces, you can also let the IP address and subnet mask be assigned by an external DHCP server on the network. In this case, the interface is a DHCP client. Virtual interfaces, however, cannot be DHCP clients. You have to assign the IP address and subnet mask manually.

In general, the IP address and subnet mask of each interface should not overlap, though it is possible for this to happen with DHCP clients.

In the example above, if the ZyWALL gets a packet with a destination address of 5.5.5.5, it might not find any entries in the routing table. In this case, the packet is dropped. However, if there is a default router to which the ZyWALL should send this packet, you can specify it as a gateway in one of the interfaces. For example, if there is a default router at 200.200.200.100, you can create a gateway at 200.200.200.100 on ge2. In this case, the ZyWALL creates the following entry in the routing table.

Table 74 Example: Routing Table Entry for a Gateway

IP ADDRESS(ES)	DESTINATION
0.0.0.0/0	200.200.200.10 0

The gateway is an optional setting for each interface. If there is more than one gateway, the ZyWALL uses the gateway with the lowest metric, or cost. If two or more gateways have the same metric, the ZyWALL uses the one that was set up first (the first entry in the routing table). In PPPoE/PPTP interfaces, the other computer is the gateway for the interface by default. In this case, you should specify the metric.

If the interface gets its IP address and subnet mask from a DHCP server, the DHCP server also specifies the gateway, if any.

Interface Parameters

The ZyWALL restricts the amount of traffic into and out of the ZyWALL through each interface.

- Egress bandwidth sets the amount of traffic the ZyWALL sends out through the interface to the network.
- Ingress bandwidth sets the amount of traffic the ZyWALL allows in through the interface from the network.¹

1. At the time of writing, the ZyWALL does not support ingress bandwidth management.

If you set the bandwidth restrictions very high, you effectively remove the restrictions.

The ZyWALL also restricts the size of each data packet. The maximum number of bytes in each packet is called the maximum transmission unit (MTU). If a packet is larger than the MTU, the ZyWALL divides it into smaller fragments. Each fragment is sent separately, and the original packet is re-assembled later. The smaller the MTU, the more fragments sent, and the more work required to re-assemble packets correctly. On the other hand, some communication channels, such as Ethernet over ATM, might not be able to handle large data packets.

DHCP Settings

Dynamic Host Configuration Protocol (DHCP, RFC 2131, RFC 2132) provides a way to automatically set up and maintain IP addresses, subnet masks, gateways, and some network information (such as the IP addresses of DNS servers) on computers in the network. This reduces the amount of manual configuration you have to do and usually uses available IP addresses more efficiently.

In DHCP, every network has at least one DHCP server. When a computer (a DHCP client) joins the network, it submits a DHCP request. The DHCP servers get the request; assign an IP address; and provide the IP address, subnet mask, gateway, and available network information to the DHCP client. When the DHCP client leaves the network, the DHCP servers can assign its IP address to another DHCP client.

In the ZyWALL, some interfaces can provide DHCP services to the network. In this case, the interface can be a DHCP relay or a DHCP server.

As a DHCP relay, the interface routes DHCP requests to DHCP servers on different networks. You can specify more than one DHCP server. If you do, the interface routes DHCP requests to all of them. It is possible for an interface to be a DHCP relay and a DHCP client simultaneously.

As a DHCP server, the interface provides the following information to DHCP clients.

- IP address - If the DHCP client's MAC address is in the ZyWALL's static DHCP table, the interface assigns the corresponding IP address. If not, the interface assigns IP addresses from a pool, defined by the starting address of the pool and the pool size.

Table 75 Example: Assigning IP Addresses from a Pool

START IP ADDRESS	POOL SIZE	RANGE OF ASSIGNED IP ADDRESS
50.50.50.33	5	50.50.50.33 - 50.50.50.37
75.75.75.1	200	75.75.75.1 - 75.75.75.200
99.99.1.1	1023	99.99.1.1 - 99.99.4.255
120.120.120.100	100	120.120.120.100 - 120.120.120.199

The ZyWALL cannot assign the first address (network address) or the last address (broadcast address) in the subnet defined by the interface's IP address and subnet mask. For example, in the first entry, if the subnet mask is 255.255.255.0, the ZyWALL cannot assign 50.50.50.0 or 50.50.50.255. If the subnet mask is 255.255.0.0, the ZyWALL cannot assign 50.50.0.0 or 50.50.255.255. Otherwise, it can assign every IP address in the range, except the interface's IP address.

If you do not specify the starting address or the pool size, the interface the maximum range of IP addresses allowed by the interface's IP address and subnet mask. For example, if the interface's IP address is 9.9.9.1 and subnet mask is 255.255.255.0, the starting IP address in the pool is 9.9.9.2, and the pool size is 253.

- Subnet mask - The interface provides the same subnet mask you specify for the interface. See [IP Address Assignment on page 284](#).
- Gateway - The interface provides the same gateway you specify for the interface. See [IP Address Assignment on page 284](#).
- DNS servers - The interface provides IP addresses for up to three DNS servers that provide DNS services for DHCP clients. You can specify each IP address manually (for example, a company's own DNS server), or you can refer to DNS servers that other interfaces received from DHCP servers (for example, a DNS server at an ISP). These other interfaces have to be DHCP clients.

It is not possible for an interface to be the DHCP server and a DHCP client simultaneously.

WINS

WINS (Windows Internet Naming Service) is a Windows implementation of NetBIOS Name Server (NBNS) on Windows. It keeps track of NetBIOS computer names. It stores a mapping table of your network's computer names and IP addresses. The table is dynamically updated for IP addresses assigned by DHCP. This helps reduce broadcast traffic since computers can query the server instead of broadcasting a request for a computer name's IP address. In this way WINS is similar to DNS, although WINS does not use a hierarchy (unlike DNS). A network can have more than one WINS server. Samba can also serve as a WINS server.

PPPoE/PPTP Overview

Point-to-Point Protocol over Ethernet (PPPoE, RFC 2516) and Point-to-Point Tunneling Protocol (PPTP, RFC 2637) are usually used to connect two computers over phone lines or broadband connections. PPPoE is often used with cable modems and DSL connections. It provides the following advantages:

- The access and authentication method works with existing systems, including RADIUS.
- You can access one of several network services. This makes it easier for the service provider to offer the service
- PPPoE does not usually require any special configuration of the modem.

PPTP is used to set up virtual private networks (VPN) in unsecure TCP/IP environments. It sets up two sessions.

- 1 The first one runs on TCP port 1723. It is used to start and manage the second one.
- 2 The second one uses Generic Routing Encapsulation (GRE, RFC 2890) to transfer information between the computers.

PPTP is convenient and easy-to-use, but you have to make sure that firewalls support both PPTP sessions.

12.1 Overview

Use trunks for WAN traffic load balancing to increase overall network throughput and reliability. Load balancing divides traffic loads between multiple interfaces. This allows you to improve quality of service and maximize bandwidth utilization for multiple ISP links.

Maybe you have two Internet connections with different bandwidths. You could set up a trunk that uses spillover or weighted round robin load balancing so time-sensitive traffic (like video) usually goes through the higher-bandwidth interface. For other traffic, you might want to use least load first load balancing to even out the distribution of the traffic load.

Suppose ISP A has better connections to Europe while ISP B has better connections to Australia. You could use policy routes and trunks to have traffic for your European branch office primarily use ISP A and traffic for your Australian branch office primarily use ISP B.

Or maybe one of the ZyWALL's interfaces is connected to an ISP that is also your Voice over IP (VoIP) service provider. You can use policy routing to send the VoIP traffic through a trunk with the interface connected to the VoIP service provider set to active and another interface (connected to another ISP) set to passive. This way VoIP traffic goes through the interface connected to the VoIP service provider whenever the interface's connection is up.

12.1.1 What You Can Do in this Chapter

- Use the **Trunk** summary screen ([Section 12.2 on page 292](#)) to configure link sticking and view the list of configured trunks and which load balancing algorithm each trunk uses.
- Use the **Trunk Edit** screen ([Section 12.3 on page 293](#)) to configure which interfaces belong to each trunk and the load balancing algorithm each trunk uses.

12.1.2 What You Need to Know

- Add WAN interfaces to trunks to have multiple connections share the traffic load.
- If one WAN interface's connection goes down, the ZyWALL sends traffic through another member of the trunk.
- For example, you connect one WAN interface to one ISP and connect a second WAN interface to a second ISP. The ZyWALL balances the WAN traffic load between the connections. If one interface's connection goes down, the ZyWALL can automatically send its traffic through another interface.

You can also use trunks with policy routing to send specific traffic types through the best WAN interface for that type of traffic.

- If that interface's connection goes down, the ZyWALL can still send its traffic through another interface.
- You can define multiple trunks for the same physical interfaces.

Load Balancing Algorithms

The following sections describe the load balancing algorithms the ZyWALL can use to decide which interface the traffic (from the LAN) should use for a session². The available bandwidth you configure on the ZyWALL refers to the actual bandwidth provided by the ISP and the measured bandwidth refers to the bandwidth an interface is currently using.

Least Load First

The least load first algorithm uses the current (or recent) outbound bandwidth utilization of each trunk member interface as the load balancing index(es) when making decisions about to which interface a new session is to be distributed. The outbound bandwidth utilization is defined as the measured outbound throughput over the available outbound bandwidth.

Weighted Round Robin

The Weighted Round Robin (WRR) algorithm is best suited for situations when the bandwidths set for the two WAN interfaces are different. Similar to the Round Robin (RR) algorithm (see [Section 12.4 on page 295](#)), the Weighted Round Robin (WRR) algorithm sets the ZyWALL to send traffic through each interface in turn. In addition, the interfaces are assigned weights. An interface with a larger weight gets more of the traffic than an interface with a smaller weight.

2. In the load balancing section, a session may refer to normal connection-oriented, UDP or SNMP2 traffic.

Spillover

The spillover load balancing algorithm sends network traffic to the first interface in the trunk member list until the interface's maximum allowable load is reached, then sends the excess network traffic of new sessions to the next interface in the trunk member list. This continues as long as there are more member interfaces and traffic to be sent through them.

Suppose the first trunk member interface uses an unlimited access Internet connection and the second is billed by usage. Spillover load balancing only uses the second interface when the traffic load exceeds the threshold on the first interface. This fully utilizes the bandwidth of the first interface to reduce Internet usage fees and avoid overloading the interface.

Finding Out More

- See [Section 6.5.4 on page 96](#) for related information on the **Trunk** screens.
- See [Section 7.3 on page 113](#) for an example of how to configure load balancing.
- See [Section 12.4 on page 295](#) for more background information on trunks.

12.2 The Trunk Summary Screen

Click **Configuration > Network > Interface > Trunk** to open the **Trunk** screen. This screen lists the configured trunks and the load balancing algorithm that each is configured to use.

Figure 182 Configuration > Network > Interface > Trunk

The screenshot displays the ZyWALL configuration interface for the Trunk screen. At the top, there are tabs for different port roles: Port Role, Ethernet, PPP, Cellular, WLAN, VLAN, Bridge, Auxiliary, and Trunk. The Trunk tab is selected. Below the tabs, there is a 'Show Advanced Settings' button. The main content area is divided into four sections:

- Configuration:** Contains a checkbox for 'Enable Link Sticking' which is checked. Below it is a 'Timeout' field set to '300' with a note '(30-600 seconds)'. There are information icons next to the checkbox and the timeout field.
- Default WAN Trunk:** Contains a 'Default Trunk Selection' section with two radio buttons: 'SYSTEM_DEFAULT_WAN_TRUNK' (selected) and 'User Configured Trunk'. The 'User Configured Trunk' option has a dropdown menu showing '0'.
- User Configuration:** Contains a table with columns '#', 'Name', and 'Algorithm'. Above the table are buttons for 'Add', 'Edit', 'Remove', and 'Object Reference'. Below the table are navigation controls: 'Page 1 of 1', 'Show 50 items', and 'No data to display'.
- System Default:** Contains a table with columns '#', 'Name', and 'Algorithm'. Above the table are buttons for 'Edit' and 'Object Reference'. Below the table are navigation controls: 'Page 1 of 1', 'Show 50 items', and 'Displaying 1 - 1 of 1'.

At the bottom of the screen, there are 'Apply' and 'Reset' buttons.

The following table describes the items in this screen.

Table 76 Configuration > Network > Interface > Trunk

LABEL	DESCRIPTION
Show Advance Settings / Hide Advance Settings	Click this button to display a greater or lesser number of configuration fields.
Enable Link Sticking	<p>Enable link sticking to have the system route sessions from one source to the same destination through the same link for a period of time. This is useful for accessing server that are incompatible with a user's sessions coming from different links.</p> <p>For example, this is useful when a server requires authentication.</p> <p>This setting applies when you use load balancing and have multiple WAN interfaces set to active mode.</p>
Timeout	Specify the time period during which sessions from one source to the same destination are to use the same link.

Table 76 Configuration > Network > Interface > Trunk (continued)

LABEL	DESCRIPTION
Enable Default SNAT	Select this to have the ZyWALL use the IP address of the outgoing interface as the source IP address of the packets it sends out through its WAN trunks. The ZyWALL automatically adds SNAT settings for traffic it routes from internal interfaces to external interfaces.
Default Trunk Selection	Select whether the ZyWALL is to use the default system WAN trunk or one of the user configured WAN trunks as the default trunk for routing traffic from internal interfaces to external interfaces.
User Configuration / System Default	The ZyWALL automatically adds all external interfaces into the pre-configured system default SYSTEM_DEFAULT_WAN_TRUNK . You cannot delete it. You can create your own User Configuration trunks.
Add	Click this to create a new user-configured trunk.
Edit	Double-click an entry or select it and click Edit to open a screen where you can modify the entry's settings.
Remove	To remove a user-configured trunk, select it and click Remove . The ZyWALL confirms you want to remove it before doing so.
Object References	Select an entry and click Object References to open a screen that shows which settings use the entry. See Section 11.3.2 on page 232 for an example.
#	This field is a sequential value, and it is not associated with any interface.
Name	This field displays the label that you specified to identify the trunk.
Algorithm	This field displays the load balancing method the trunk is set to use.
Apply	Click this button to save your changes to the ZyWALL.
Reset	Click this button to return the screen to its last-saved settings.

12.3 Configuring a Trunk

Click **Configuration > Network > Interface > Trunk** and then the **Add** (or **Edit**) icon to open the **Trunk Edit** screen. Use this screen to create or edit a WAN trunk entry.

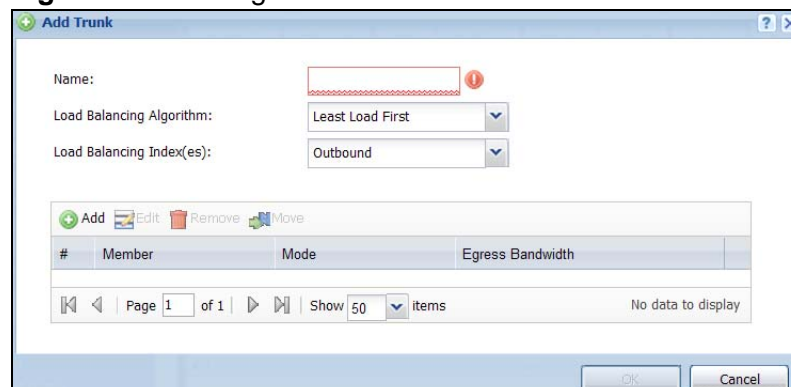
Figure 183 Configuration > Network > Interface > Trunk > Add (or Edit)

Each field is described in the table below.

Table 77 Configuration > Network > Interface > Trunk > Add (or Edit)

LABEL	DESCRIPTION
Name	This is read-only if you are editing an existing trunk. When adding a new trunk, enter a descriptive name for this trunk. You may use 1-31 alphanumeric characters, underscores(_), or dashes (-), but the first character cannot be a number. This value is case-sensitive.
Load Balancing Algorithm	<p>Select a load balancing method to use from the drop-down list box.</p> <p>Select Weighted Round Robin to balance the traffic load between interfaces based on their respective weights. Weighted round robin is activated only when the first group member interface has more traffic than it can handle.</p> <p>Select Least Load First to send new session traffic through the least utilized trunk member.</p> <p>Select Spillover to send network traffic through the first interface in the group member list until there is enough traffic that the second interface needs to be used (and so on).</p>
Load Balancing Index(es)	<p>This field is available if you selected to use the Least Load First or Spillover method.</p> <p>Select Outbound, Inbound, or Outbound + Inbound to set the traffic to which the ZyWALL applies the load balancing method. Outbound means the traffic traveling from an internal interface (ex. LAN) to an external interface (ex. WAN). Inbound means the opposite.</p>
	The table lists the trunk's member interfaces. You can add, edit, remove, or move entries for user configured trunks.
Add	Click this to add a member interface to the trunk. Select an interface and click Add to add a new member interface after the selected member interface.
Edit	Double-click an entry or select it and click Edit to open a screen where you can modify the entry's settings.
Remove	To remove a member interface, select it and click Remove . The ZyWALL confirms you want to remove it before doing so.
Move	To move an interface to a different number in the list, click the Move icon. In the field that appears, specify the number to which you want to move the interface.
#	This column displays the priorities of the group's interfaces. The order of the interfaces in the list is important since they are used in the order they are listed.
Member	Click this icon to open a screen where you can select an interface to be a group member.
Mode	<p>Select Active to have the ZyWALL always attempt to use this connection.</p> <p>Select Passive to have the ZyWALL only use this connection when all of the connections set to active are down. You can only set one of a group's interfaces to passive mode.</p>

Table 77 Configuration > Network > Interface > Trunk > Add (or Edit) (continued)

LABEL	DESCRIPTION
Weight	This field displays with the weighted round robin load balancing algorithm. Specify the weight (1~10) for the interface. The weights of the different member interfaces form a ratio. This ratio determines how much traffic the ZyWALL sends through each member interface. The higher an interface's weight is (relative to the weights of the interfaces), the more traffic the ZyWALL sends through that interface.
Ingress Bandwidth	This field displays with the least load first load balancing algorithm. It displays the maximum number of kilobits of data the ZyWALL is to allow to come in through the interface per second.
Egress Bandwidth	This field displays with the least load first or spillover load balancing algorithm. It displays the maximum number of kilobits of data the ZyWALL is to send out through the interface per second.
Spillover	This field displays with the spillover load balancing algorithm. Specify the maximum bandwidth of traffic in kilobits per second (1~1048576) to send out through the interface before using another interface. When this spillover bandwidth limit is exceeded, the ZyWALL sends new session traffic through the next interface. The traffic of existing sessions still goes through the interface on which they started. The ZyWALL uses the group member interfaces in the order that they are listed.
OK	Click OK to save your changes back to the ZyWALL.
Cancel	Click Cancel to exit this screen without saving.

12.4 Trunk Technical Reference

Round Robin Load Balancing Algorithm

Round Robin scheduling services queues on a rotating basis and is activated only when an interface has more traffic than it can handle. A queue is given an amount of bandwidth irrespective of the incoming traffic on that interface. This queue then moves to the back of the list. The next queue is given an equal amount of bandwidth, and then moves to the end of the list; and so on, depending on the number of queues being used. This works in a looping fashion until a queue is empty.

Policy and Static Routes

13.1 Policy and Static Routes Overview

Use policy routes and static routes to override the ZyWALL's default routing behavior in order to send packets through the appropriate interface or VPN tunnel.

For example, the next figure shows a computer (**A**) connected to the ZyWALL's LAN interface. The ZyWALL routes most traffic from **A** to the Internet through the ZyWALL's default gateway (**R1**). You create one policy route to connect to services offered by your ISP behind router **R2**. You create another policy route to communicate with a separate network behind another router (**R3**) connected to the LAN.

Figure 184 Example of Policy Routing Topology

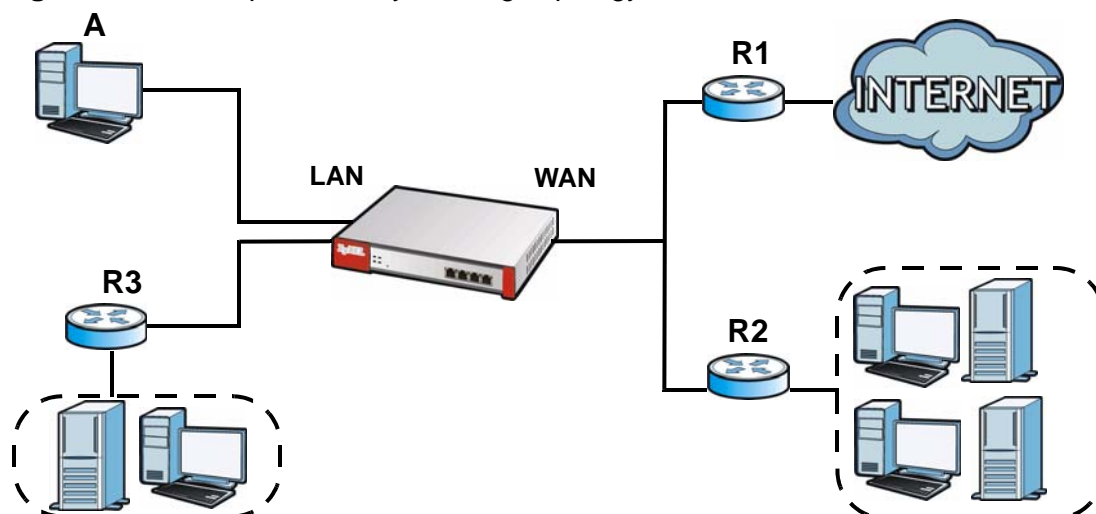

Note: You can generally just use policy routes. You only need to use static routes if you have a large network with multiple routers where you use RIP or OSPF to propagate routing information to other routers.

13.1.1 What You Can Do in this Chapter

- Use the **Policy Route** screens (see [Section 13.2 on page 300](#)) to list and configure policy routes.

- Use the **Static Route** screens (see [Section 13.3 on page 307](#)) to list and configure static routes.

13.1.2 What You Need to Know

Policy Routing

Traditionally, routing is based on the destination address only and the ZyWALL takes the shortest path to forward a packet. IP Policy Routing (IPPR) provides a mechanism to override the default routing behavior and alter the packet forwarding based on the policy defined by the network administrator. Policy-based routing is applied to incoming packets on a per interface basis, prior to the normal routing.

How You Can Use Policy Routing

- **Source-Based Routing** – Network administrators can use policy-based routing to direct traffic from different users through different connections.
- **Bandwidth Shaping** – You can allocate bandwidth to traffic that matches routing policies and prioritize traffic. You can also use policy routes to manage other types of traffic (like ICMP traffic) and send traffic through VPN tunnels.
- **Cost Savings** – IPPR allows organizations to distribute interactive traffic on high-bandwidth, high-cost paths while using low-cost paths for batch traffic.
- **Load Sharing** – Network administrators can use IPPR to distribute traffic among multiple paths.
- **NAT** - The ZyWALL performs NAT by default for traffic going to or from the **WAN** interfaces. A routing policy's SNAT allows network administrators to have traffic received on a specified interface use a specified IP address as the source IP address.

Note: The ZyWALL automatically uses SNAT for traffic it routes from internal interfaces to external interfaces. For example LAN to WAN traffic.

Static Routes

The ZyWALL usually uses the default gateway to route outbound traffic from computers on the LAN to the Internet. To have the ZyWALL send data to devices not reachable through the default gateway, use static routes. Configure static routes if you need to use RIP or OSPF to propagate the routing information to other routers. See [Chapter 14 on page 313](#) for more on RIP and OSPF.

Policy Routes Versus Static Routes

- Policy routes are more flexible than static routes. You can select more criteria for the traffic to match and can also use schedules, NAT, and bandwidth management.

- Policy routes are only used within the ZyWALL itself. Static routes can be propagated to other routers using RIP or OSPF.
- Policy routes take priority over static routes. If you need to use a routing policy on the ZyWALL and propagate it to other routers, you could configure a policy route and an equivalent static route.

DiffServ

QoS is used to prioritize source-to-destination traffic flows. All packets in the same flow are given the same priority. CoS (class of service) is a way of managing traffic in a network by grouping similar types of traffic together and treating each type as a class. You can use CoS to give different priorities to different packet types.

DiffServ (Differentiated Services) is a class of service (CoS) model that marks packets so that they receive specific per-hop treatment at DiffServ-compliant network devices along the route based on the application types and traffic flow. Packets are marked with DiffServ Code Points (DSCPs) indicating the level of service desired. This allows the intermediary DiffServ-compliant network devices to handle the packets differently depending on the code points without the need to negotiate paths or remember state information for every flow. In addition, applications do not have to request a particular service or give advanced notice of where the traffic is going.

DSCP Marking and Per-Hop Behavior

DiffServ defines a new DS (Differentiated Services) field to replace the Type of Service (TOS) field in the IP header. The DS field contains a 2-bit unused field and a 6-bit DSCP field which can define up to 64 service levels. The following figure illustrates the DS field.

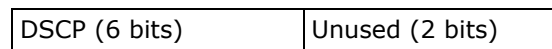

DSCP is backward compatible with the three precedence bits in the ToS octet so that non-DiffServ compliant, ToS-enabled network device will not conflict with the DSCP mapping.

The DSCP value determines the forwarding behavior, the PHB (Per-Hop Behavior), that each packet gets across the DiffServ network. Based on the marking rule, different kinds of traffic can be marked for different kinds of forwarding. Resources can then be allocated according to the DSCP values and the configured policies.

Finding Out More

- See [Section 6.5.5 on page 96](#) for related information on the policy route screens.
- See [Section 7.12 on page 145](#) for an example of creating a policy route for using multiple static public WAN IP addresses for LAN to WAN traffic.

- See [Section 13.4 on page 309](#) for more background information on policy routing.

13.2 Policy Route Screen

Click **Configuration > Network > Routing** to open the **Policy Route** screen. Use this screen to see the configured policy routes and turn policy routing based bandwidth management on or off.

A policy route defines the matching criteria and the action to take when a packet meets the criteria. The action is taken only when all the criteria are met. The criteria can include the user name, source address and incoming interface, destination address, schedule, IP protocol (ICMP, UDP, TCP, etc.) and port.

The actions that can be taken include:

- Routing the packet to a different gateway, outgoing interface, VPN tunnel, or trunk.
- Limiting the amount of bandwidth available and setting a priority for traffic.

IPPR follows the existing packet filtering facility of RAS in style and in implementation.

Figure 185 Configuration > Network > Routing > Policy Route

BWM Global Setting

Enable BWM

Configuration

Use Policy Route to Override Direct Route

#	Status	User	Schedule	Incoming	Source	Destination	DSCP Code	Service	Next-Hop	DSCP Mark	SNAT	BWM
1		any	none	lan1	VMZ_VPN_LC	VMZ_VPN	any	any	VMZ_VPN	preserve	none	0

The following table describes the labels in this screen.

Table 78 Configuration > Network > Routing > Policy Route

LABEL	DESCRIPTION
Show Advance Settings / Hide Advance Settings	Click this button to display a greater or lesser number of configuration fields.
Enable BWM	This is a global setting for enabling or disabling bandwidth management on the ZyWALL. You must enable this setting to have individual policy routes.
Use Policy Route to Override Direct Route	Select this to have the ZyWALL forward packets that match a policy route according to the policy route instead of sending the packets directly to a connected network. See Section 6.4.1 on page 92 for how this option affects the routing table.
Add	Click this to create a new entry. Select an entry and click Add to create a new entry after the selected entry.
Edit	Double-click an entry or select it and click Edit to open a screen where you can modify the entry's settings.
Remove	To remove an entry, select it and click Remove . The ZyWALL confirms you want to remove it before doing so.
Activate	To turn on an entry, select it and click Activate .
Inactivate	To turn off an entry, select it and click Inactivate .
Move	To change a rule's position in the numbered list, select the rule and click Move to display a field to type a number for where you want to put that rule and press [ENTER] to move the rule to the number that you typed. The ordering of your rules is important as they are applied in order of their numbering.
#	This is the number of an individual policy route.
Status	This icon is lit when the entry is active, red when the next hop's connection is down, and dimmed when the entry is inactive.
User	This is the name of the user (group) object from which the packets are sent. any means all users.
Schedule	This is the name of the schedule object. none means the route is active at all times if enabled.
Incoming	This is the interface on which the packets are received.
Source	This is the name of the source IP address (group) object. any means all IP addresses.
Destination	This is the name of the destination IP address (group) object. any means all IP addresses.

Table 78 Configuration > Network > Routing > Policy Route (continued)

LABEL	DESCRIPTION
DSCP Code	<p>This is the DSCP value of incoming packets to which this policy route applies.</p> <p>any means all DSCP values or no DSCP marker.</p> <p>default means traffic with a DSCP value of 0. This is usually best effort traffic</p> <p>The "af" entries stand for Assured Forwarding. The number following the "af" identifies one of four classes and one of three drop preferences. See Assured Forwarding (AF) PHB for DiffServ on page 309 for more details.</p>
Service	This is the name of the service object. any means all services.
Next-Hop	This is the next hop to which packets are directed. It helps forward packets to their destinations and can be a router, VPN tunnel, outgoing interface or trunk.
DSCP Marking	<p>This is how the ZyWALL handles the DSCP value of the outgoing packets that match this route. If this field displays a DSCP value, the ZyWALL applies that DSCP value to the route's outgoing packets.</p> <p>preserve means the ZyWALL does not modify the DSCP value of the route's outgoing packets.</p> <p>default means the ZyWALL sets the DSCP value of the route's outgoing packets to 0.</p> <p>The "af" choices stand for Assured Forwarding. The number following the "af" identifies one of four classes and one of three drop preferences. See Assured Forwarding (AF) PHB for DiffServ on page 309 for more details.</p>
SNAT	<p>This is the source IP address that the route uses.</p> <p>It displays none if the ZyWALL does not perform NAT for this route.</p>
BWM	This is the maximum bandwidth allotted to the policy. 0 means there is no bandwidth limitation for this route.
Apply	Click Apply to save your changes back to the ZyWALL.
Reset	Click Reset to return the screen to its last-saved settings.

13.2.1 Policy Route Edit Screen

Click **Configuration > Network > Routing** to open the **Policy Route** screen. Then click the **Add** or **Edit** icon to open the **Policy Route Edit** screen. Use this screen to configure or edit a policy route.

Figure 186 Configuration > Network > Routing > Policy Route > Add

The following table describes the labels in this screen.

Table 79 Configuration > Network > Routing > Policy Route > Edit

LABEL	DESCRIPTION
Create new Object	Use this to configure any new settings objects that you need to use in this screen.
Configuration	
Enable	Select this to activate the policy.
Description	Enter a descriptive name of up to 31 printable ASCII characters for the policy.
Criteria	
User	Select a user name or user group from which the packets are sent.

Table 79 Configuration > Network > Routing > Policy Route > Edit (continued)

LABEL	DESCRIPTION
Incoming	Select where the packets are coming from; any, an interface, a tunnel, an SSL VPN, or the ZyWALL itself. For an interface, a tunnel, or an SSL VPN, you also need to select the individual interface, VPN tunnel, or SSL VPN connection.
Source Address	Select a source IP address object from which the packets are sent.
Destination Address	Select a destination IP address object to which the traffic is being sent. If the next hop is a dynamic VPN tunnel and you enable Auto Destination Address , the ZyWALL uses the local network of the peer router that initiated an incoming dynamic IPsec tunnel as the destination address of the policy instead of your configuration here.
DSCP Code	Select a DSCP code point value of incoming packets to which this policy route applies or select User Defined to specify another DSCP code point. The lower the number the higher the priority with the exception of 0 which is usually given only best-effort treatment. any means all DSCP value or no DSCP marker. default means traffic with a DSCP value of 0. This is usually best effort traffic The "af" choices stand for Assured Forwarding. The number following the "af" identifies one of four classes and one of three drop preferences. See Assured Forwarding (AF) PHB for DiffServ on page 309 for more details.
User-Defined DSCP Code	Use this field to specify a custom DSCP code point.
Schedule	Select a schedule to control when the policy route is active. none means the route is active at all times if enabled.
Service	Select a service or service group to identify the type of traffic to which this policy route applies.
Next-Hop	
Type	Select Auto to have the ZyWALL use the routing table to find a next-hop and forward the matched packets automatically. Select Gateway to route the matched packets to the next-hop router or switch you specified in the Gateway field. You have to set up the next-hop router or switch as a HOST address object first. Select VPN Tunnel to route the matched packets via the specified VPN tunnel. Select Trunk to route the matched packets through the interfaces in the trunk group based on the load balancing algorithm. Select Interface to route the matched packets through the specified outgoing interface to a gateway (which is connected to the interface).
Gateway	This field displays when you select Gateway in the Type field. Select a HOST address object. The gateway is an immediate neighbor of your ZyWALL that will forward the packet to the destination. The gateway must be a router or switch on the same segment as your ZyWALL's interface(s).

Table 79 Configuration > Network > Routing > Policy Route > Edit (continued)

LABEL	DESCRIPTION
VPN Tunnel	This field displays when you select VPN Tunnel in the Type field. Select a VPN tunnel through which the packets are sent to the remote network that is connected to the ZyWALL directly.
Auto Destination Address	This field displays when you select VPN Tunnel in the Type field. Select this to have the ZyWALL use the local network of the peer router that initiated an incoming dynamic IPSectunnel as the destination address of the policy. Leave this cleared if you want to manually specify the destination address.
Trunk	This field displays when you select Trunk in the Type field. Select a trunk group to have the ZyWALL send the packets via the interfaces in the group.
Interface	This field displays when you select Interface in the Type field. Select an interface to have the ZyWALL send traffic that matches the policy route through the specified interface.
Auto-Disable	This field displays when you select Interface or Trunk in the Type field. Select this to have the ZyWALL automatically disable this policy route when the next hop's connection is down.
DSCP Marking	
DSCP Marking	Set how the ZyWALL handles the DSCP value of the outgoing packets that match this route. Select one of the pre-defined DSCP values to apply or select User Defined to specify another DSCP value. The " af " choices stand for Assured Forwarding. The number following the " af " identifies one of four classes and one of three drop preferences. See Assured Forwarding (AF) PHB for DiffServ on page 309 for more details. Select preserve to have the ZyWALL keep the packets' original DSCP value. Select default to have the ZyWALL set the DSCP value of the packets to 0.
User-Defined DSCP Code	Use this field to specify a custom DSCP value.
Address Translation	Use this section to configure NAT for the policy route. This section does not apply to policy routes that use a VPN tunnel as the next hop.

Table 79 Configuration > Network > Routing > Policy Route > Edit (continued)

LABEL	DESCRIPTION
Source Network Address Translation	<p>Select none to not use NAT for the route.</p> <p>Select outgoing-interface to use the IP address of the outgoing interface as the source IP address of the packets that matches this route. If you select outgoing-interface, you can also configure port trigger settings for this interface.</p> <p>To use SNAT for a virtual interface that is in the same WAN trunk as the physical interface to which the virtual interface is bound, the virtual interface and physical interface must be in different subnets.</p> <p>Otherwise, select a pre-defined address (group) to use as the source IP address(es) of the packets that match this route.</p> <p>Use Create new Object if you need to configure a new address (group) to use as the source IP address(es) of the packets that match this route.</p>
Port Triggering	<p>Configure trigger port forwarding to allow computers on the LAN to dynamically take turns using a service that uses a dedicated range of ports on the client side and a dedicated range of ports on the server side.</p> <p>Note: You need to create a firewall rule to allow an incoming service before using a port triggering rule.</p>
Add	Click this to create a new entry. Select an entry and click Add to create a new entry after the selected entry.
Edit	Select an entry and click this to be able to modify it. You can also just double-click an entry to be able to modify it.
Remove	Select an entry and click this to delete it.
Move	<p>The ordering of your rules is important as they are applied in order of their numbering.</p> <p>To move an entry to a different number in the list, click the Move icon. In the field that appears, specify the number to which you want to move the entry.</p>
#	This is the rule index number.
Incoming Service	<p>Select the service that the client computer sends to a remote server.</p> <p>The incoming service should have the same service or protocol type as what you configured in the Service field.</p>
Trigger Service	Select a service that a remote server sends. It causes (triggers) the ZyWALL to forward the traffic (received on the outgoing interface) to the client computer that requested the service.
Bandwidth Shaping	<p>This allows you to allocate bandwidth to a route and prioritize traffic that matches the routing policy.</p> <p>You must also enable bandwidth management in the main policy route screen (Network > Routing > Policy Route) in order to apply bandwidth shaping.</p>

Table 79 Configuration > Network > Routing > Policy Route > Edit (continued)

LABEL	DESCRIPTION
Maximum Bandwidth	<p>Specify the maximum bandwidth (from 1 to 1048576) allowed for the route in kbps. If you enter 0 here, there is no bandwidth limitation for the route.</p> <p>If the sum of the bandwidths for routes using the same next hop is higher than the actual transmission speed, lower priority traffic may not be sent if higher priority traffic uses all of the actual bandwidth.</p> <p>To reserve bandwidth for traffic that does not match any of the policy routes, leave some of the interface's bandwidth unbudgeted and do not enable Maximize Bandwidth Usage.</p>
Bandwidth Priority	<p>Enter a number between 1 and 7 to set the priority for traffic. The smaller the number, the higher the priority. If you set the maximum bandwidth to 0, the bandwidth priority will be changed to 0 after you click OK. That means the route has the highest priority and will get all the bandwidth it needs up to the maximum available.</p> <p>A route with higher priority is given bandwidth before a route with lower priority.</p> <p>If you set routes to have the same priority, then bandwidth is divided equally amongst those routes.</p>
Maximize Bandwidth Usage	Select this check box to have the ZyWALL divide up all of the interface's unallocated and/or unused bandwidth among the policy routes that require bandwidth. Do not select this if you want to reserve bandwidth for traffic that does not match any of the policy routes.
OK	Click OK to save your changes back to the ZyWALL.
Cancel	Click Cancel to exit this screen without saving.

13.3 IP Static Route Screen

Click **Configuration > Network > Routing > Static Route** to open the **Static Route** screen. This screen displays the configured static routes. Configure static routes to be able to use RIP or OSPF to propagate the routing information to other routers.

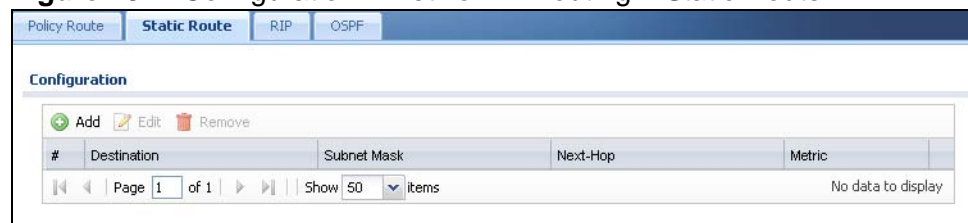
Figure 187 Configuration > Network > Routing > Static Route

The following table describes the labels in this screen.

Table 80 Configuration > Network > Routing > Static Route

LABEL	DESCRIPTION
Add	Click this to create a new static route.
Edit	Double-click an entry or select it and click Edit to open a screen where you can modify the entry's settings.
Remove	To remove an entry, select it and click Remove . The ZyWALL confirms you want to remove it before doing so.
#	This is the number of an individual static route.
Destination	This is the destination IP address.
Subnet Mask	This is the IP subnet mask.
Next-Hop	This is the IP address of the next-hop gateway or the interface through which the traffic is routed. The gateway is a router or switch on the same segment as your ZyWALL's interface(s). The gateway helps forward packets to their destinations.
Metric	This is the route's priority among the ZyWALL's routes. The smaller the number, the higher priority the route has.

13.3.1 Static Route Add/Edit Screen

Select a static route index number and click **Add** or **Edit**. The screen shown next appears. Use this screen to configure the required information for a static route.

Figure 188 Configuration > Network > Routing > Static Route > Add

The following table describes the labels in this screen.

Table 81 Configuration > Network > Routing > Static Route > Add

LABEL	DESCRIPTION
Destination IP	This parameter specifies the IP network address of the final destination. Routing is always based on network number. If you need to specify a route to a single host, use a subnet mask of 255.255.255.255 in the subnet mask field to force the network number to be identical to the host ID.
Subnet Mask	Enter the IP subnet mask here.

Table 81 Configuration > Network > Routing > Static Route > Add (continued)

LABEL	DESCRIPTION
Gateway IP	Select the radio button and enter the IP address of the next-hop gateway. The gateway is a router or switch on the same segment as your ZyWALL's interface(s). The gateway helps forward packets to their destinations.
Interface	Select the radio button and a predefined interface through which the traffic is sent.
Metric	Metric represents the "cost" of transmission for routing purposes. IP routing uses hop count as the measurement of cost, with a minimum of 1 for directly connected networks. Enter a number that approximates the cost for this link. The number need not be precise, but it must be 0~127. In practice, 2 or 3 is usually a good number.
OK	Click OK to save your changes back to the ZyWALL.
Cancel	Click Cancel to exit this screen without saving.

13.4 Policy Routing Technical Reference

Here is more detailed information about some of the features you can configure in policy routing.

NAT and SNAT

NAT (Network Address Translation - NAT, RFC 1631) is the translation of the IP address in a packet in one network to a different IP address in another network. Use SNAT (Source NAT) to change the source IP address in one network to a different IP address in another network.

Assured Forwarding (AF) PHB for DiffServ

Assured Forwarding (AF) behavior is defined in RFC 2597. The AF behavior group defines four AF classes. Inside each class, packets are given a high, medium or low drop precedence. The drop precedence determines the probability that routers in the network will drop packets when congestion occurs. If congestion occurs between classes, the traffic in the higher class (smaller numbered class) is generally given priority. Combining the classes and drop precedence produces the

following twelve DSCP encodings from AF11 through AF43. The decimal equivalent is listed in brackets.

Table 82 Assured Forwarding (AF) Behavior Group

	Class 1	Class 2	Class 3	Class 4
Low Drop Precedence	AF11 (10)	AF21 (18)	AF31 (26)	AF41 (34)
Medium Drop Precedence	AF12 (12)	AF22 (20)	AF32 (28)	AF42 (36)
High Drop Precedence	AF13 (14)	AF23 (22)	AF33 (30)	AF43 (38)

Port Triggering

Some services use a dedicated range of ports on the client side and a dedicated range of ports on the server side. With regular port forwarding, you set the port(s) and IP address to forward a service (coming in from the remote server) to a client computer. The problem is that port forwarding only forwards a service to a single IP address. In order to use the same service on a different computer, you have to manually replace the client computer's IP address with another client computer's IP address.

Port triggering allows the client computer to take turns using a service dynamically. Whenever a client computer's packets match the routing policy, it can use the pre-defined port triggering setting to connect to the remote server without manually configuring a port forwarding rule for each client computer.

Port triggering is used especially when the remote server responds using a different port from the port the client computer used to request a service. The ZyWALL records the IP address of a client computer that sends traffic to a remote server to request a service (incoming service). When the ZyWALL receives a new connection (trigger service) from the remote server, the ZyWALL forwards the traffic to the IP address of the client computer that sent the request.

In the following example, you configure two services for port triggering:

Incoming service: Game (UDP: 1234)
Trigger service: Game-1 (UDP: 5670-5678)

- 1 Computer **A** wants to play a multiplayer online game and tries to connect to game server **1** using port 1234. The ZyWALL records the IP address of computer **A** when the packets match a policy with SNAT configured.
- 2 Game server **1** responds using a port number ranging between 5670 - 5678. The ZyWALL allows and forwards the traffic to computer **A**.

- 3 Computer **A** and game server **1** are connected to each other until the connection is closed or times out. Any other computers (such as **B** or **C**) cannot connect to remote server **1** using the same port triggering rule as computer **A** unless they are using a different next hop (gateway, outgoing interface, VPN tunnel or trunk) from computer **A** or until the connection is closed or times out.

Figure 189 Trigger Port Forwarding Example

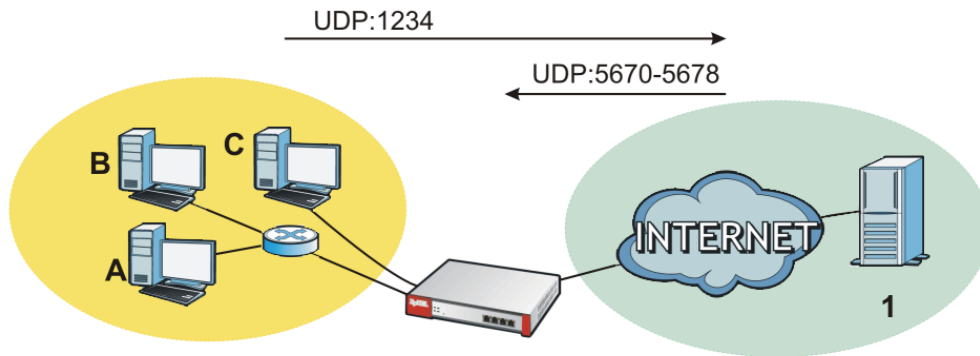

Maximize Bandwidth Usage

The maximize bandwidth usage option allows the ZyWALL to divide up any available bandwidth on the interface (including unallocated bandwidth and any allocated bandwidth that a policy route is not using) among the policy routes that require more bandwidth.

When you enable maximize bandwidth usage, the ZyWALL first makes sure that each policy route gets up to its bandwidth allotment. Next, the ZyWALL divides up an interface's available bandwidth (bandwidth that is unbudgeted or unused by the policy routes) depending on how many policy routes require more bandwidth and on their priority levels. When only one policy route requires more bandwidth, the ZyWALL gives the extra bandwidth to that policy route.

When multiple policy routes require more bandwidth, the ZyWALL gives the highest priority policy routes the available bandwidth first (as much as they require, if there is enough available bandwidth), and then to lower priority policy routes if there is still bandwidth available. The ZyWALL distributes the available bandwidth equally among policy routes with the same priority level.

Routing Protocols

14.1 Routing Protocols Overview

Routing protocols give the ZyWALL routing information about the network from other routers. The ZyWALL stores this routing information in the routing table it uses to make routing decisions. In turn, the ZyWALL can also use routing protocols to propagate routing information to other routers. See [Section 6.6 on page 103](#) for related information on the RIP and OSPF screens.

Routing protocols are usually only used in networks using multiple routers like campuses or large enterprises.

14.1.1 What You Can Do in this Chapter

- Use the **RIP** screen (see [Section 14.2 on page 314](#)) to configure the ZyWALL to use RIP to receive and/or send routing information.
- Use the **OSPF** screen (see [Section 14.3 on page 315](#)) to configure general OSPF settings and manage OSPF areas.
- Use the **OSPF Area Add/Edit** screen (see [Section 14.3.2 on page 322](#)) to create or edit an OSPF area.

14.1.2 What You Need to Know

The ZyWALL supports two standards, RIP and OSPF, for routing protocols. RIP and OSPF are compared here and discussed further in the rest of the chapter.

Table 83 RIP vs. OSPF

	RIP	OSPF
Network Size	Small (with up to 15 routers)	Large
Metric	Hop count	Bandwidth, hop count, throughput, round trip time and reliability.
Convergence	Slow	Fast

Finding Out More

See [Section 14.4 on page 324](#) for background information on routing protocols.

14.2 The RIP Screen

RIP (Routing Information Protocol, RFC 1058 and RFC 1389) allows a device to exchange routing information with other routers. RIP is a vector-space routing protocol, and, like most such protocols, it uses hop count to decide which route is the shortest. Unfortunately, it also broadcasts its routes asynchronously to the network and converges slowly. Therefore, RIP is more suitable for small networks (up to 15 routers).

- In the ZyWALL, you can configure two sets of RIP settings before you can use it in an interface.
- First, the **Authentication** field specifies how to verify that the routing information that is received is the same routing information that is sent. This is discussed in more detail in [Authentication Types on page 325](#).
- Second, the ZyWALL can also **redistribute** routing information from non-RIP networks, specifically OSPF networks and static routes, to the RIP network. Costs might be calculated differently, however, so you use the **Metric** field to specify the cost in RIP terms.
- RIP uses UDP port 520.

Use the **RIP** screen to specify the authentication method and maintain the policies for redistribution.

Click **Configuration > Network > Routing > RIP** to open the following screen.

Figure 190 Configuration > Network > Routing > RIP

The screenshot shows the configuration interface for RIP. At the top, there are tabs for 'Policy Route', 'Static Route', 'RIP', and 'OSPF'. The 'RIP' tab is selected. Below the tabs, there are two main sections: 'General Settings' and 'Redistribute'. In the 'General Settings' section, 'Authentication' is set to 'MD5'. Below it are fields for 'MD5 Authentication ID' (with a range of 1..255) and 'MD5 Authentication Key'. In the 'Redistribute' section, there are two checked checkboxes: 'Active OSPF' and 'Active Static Route'. Each has a 'Metric' field set to '0' with a range of '(0-16)'. At the bottom right, there are 'Apply' and 'Reset' buttons.

The following table describes the labels in this screen.

Table 84 Configuration > Network > Routing Protocol > RIP

LABEL	DESCRIPTION
Authentication	
Authentication	Select the authentication method used in the RIP network. This authentication protects the integrity, but not the confidentiality, of routing updates. None uses no authentication. Text uses a plain text password that is sent over the network (not very secure). MD5 uses an MD5 password and authentication ID (most secure).
Text Authentication Key	This field is available if the Authentication is Text . Type the password for text authentication. The key can consist of alphanumeric characters and the underscore, and it can be up to 16 characters long.
MD5 Authentication ID	This field is available if the Authentication is MD5 . Type the ID for MD5 authentication. The ID can be between 1 and 255.
MD5 Authentication Key	This field is available if the Authentication is MD5 . Type the password for MD5 authentication. The password can consist of alphanumeric characters and the underscore, and it can be up to 16 characters long.
Redistribute	
Active OSPF	Select this to use RIP to advertise routes that were learned through OSPF.
Metric	Type the cost for routes provided by OSPF. The metric represents the "cost" of transmission for routing purposes. RIP routing uses hop count as the measurement of cost, with 1 usually used for directly connected networks. The number does not have to be precise, but it must be between 0 and 16. In practice, 2 or 3 is usually used.
Active Static Route	Select this to use RIP to advertise routes that were learned through the static route configuration.
Metric	Type the cost for routes provided by the static route configuration. The metric represents the "cost" of transmission for routing purposes. RIP routing uses hop count as the measurement of cost, with 1 usually used for directly connected networks. The number does not have to be precise, but it must be between 0 and 16. In practice, 2 or 3 is usually used.
Apply	Click this button to save your changes to the ZyWALL.
Reset	Click this button to return the screen to its last-saved settings.

14.3 The OSPF Screen

OSPF (Open Shortest Path First, RFC 2328) is a link-state protocol designed to distribute routing information within a group of networks, called an Autonomous

System (AS). OSPF offers some advantages over vector-space routing protocols like RIP.

- OSPF supports variable-length subnet masks, which can be set up to use available IP addresses more efficiently.
- OSPF filters and summarizes routing information, which reduces the size of routing tables throughout the network.
- OSPF responds to changes in the network, such as the loss of a router, more quickly.
- OSPF considers several factors, including bandwidth, hop count, throughput, round trip time, and reliability, when it calculates the shortest path.
- OSPF converges more quickly than RIP.

Naturally, OSPF is also more complicated than RIP, so OSPF is usually more suitable for large networks.

OSPF uses IP protocol 89.

OSPF Areas

An OSPF Autonomous System (AS) is divided into one or more areas. Each area represents a group of adjacent networks and is identified by a 32-bit ID. In OSPF, this number may be expressed as an integer or as an IP address.

There are several types of areas.

- The backbone is the transit area that routes packets between other areas. All other areas are connected to the backbone.
- A normal area is a group of adjacent networks. A normal area has routing information about the OSPF AS, any networks outside the OSPF AS to which it is directly connected, and any networks outside the OSPF AS that provide routing information to any area in the OSPF AS.
- A stub area has routing information about the OSPF AS. It does not have any routing information about any networks outside the OSPF AS, including networks to which it is directly connected. It relies on a default route to send information outside the OSPF AS.
- A Not So Stubby Area (NSSA, RFC 1587) has routing information about the OSPF AS and networks outside the OSPF AS to which the NSSA is directly connected. It does not have any routing information about other networks outside the OSPF AS.

Each type of area is illustrated in the following figure.

Figure 191 OSPF: Types of Areas

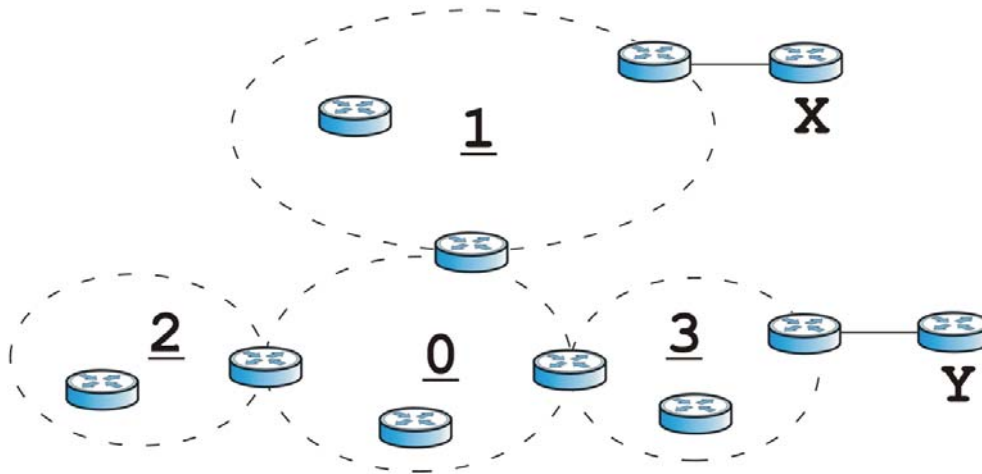

This OSPF AS consists of four areas, areas 0-3. Area 0 is always the backbone. In this example, areas 1, 2, and 3 are all connected to it. Area 1 is a normal area. It has routing information about the OSPF AS and networks X and Y. Area 2 is a stub area. It has routing information about the OSPF AS, but it depends on a default route to send information to networks X and Y. Area 3 is a NSSA. It has routing information about the OSPF AS and network Y but not about network X.

OSPF Routers

Every router in the same area has the same routing information. They do this by exchanging Hello messages to confirm which neighbor (layer-3) devices exist, and then they exchange database descriptions (DDs) to create a synchronized link-state database. The link-state database contains records of router IDs, their associated links and path costs. The link-state database is then constantly updated through Link State Advertisements (LSA). Each router uses the link state database and the Dijkstra algorithm to compute the least cost paths to network destinations.

Like areas, each router has a unique 32-bit ID in the OSPF AS, and there are several types of routers. Each type is really just a different role, and it is possible for one router to play multiple roles at one time.

- An internal router (IR) only exchanges routing information with other routers in the same area.
- An Area Border Router (ABR) connects two or more areas. It is a member of all the areas to which it is connected, and it filters, summarizes, and exchanges routing information between them.

- An Autonomous System Boundary Router (ASBR) exchanges routing information with routers in networks outside the OSPF AS. This is called redistribution in OSPF.

Table 85 OSPF: Redistribution from Other Sources to Each Type of Area

SOURCE \ TYPE OF AREA	NORMAL	NSSA	STUB
Static routes	Yes	Yes	No
RIP	Yes	Yes	Yes

- A backbone router (BR) has at least one interface with area 0. By default, every router in area 0 is a backbone router, and so is every ABR.

Each type of router is illustrated in the following example.

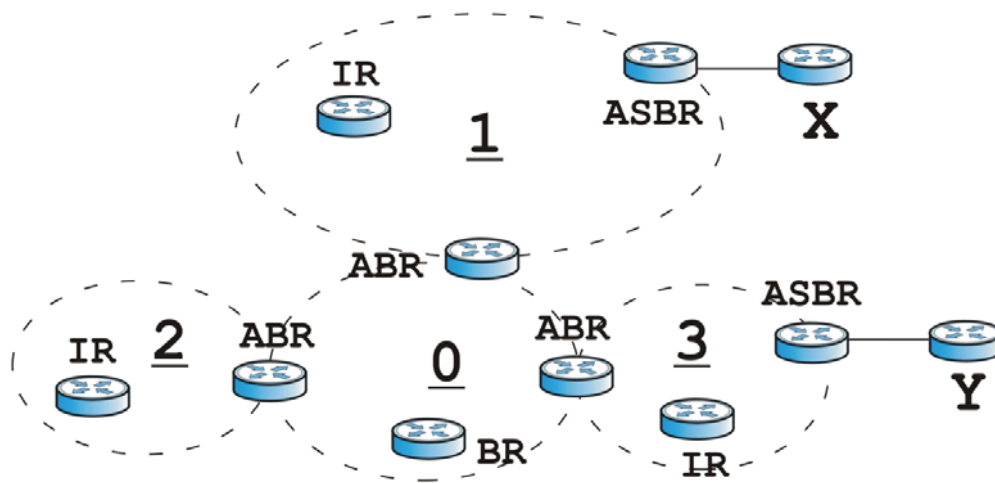
Figure 192 OSPF: Types of Routers

In order to reduce the amount of traffic between routers, a group of routers that are directly connected to each other selects a designated router (DR) and a backup designated router (BDR). All of the routers only exchange information with the DR and the BDR, instead of exchanging information with all of the other routers in the group. The DR and BDR are selected by priority; if two routers have the same priority, the highest router ID is used.

The DR and BDR are selected in each group of routers that are directly connected to each other. If a router is directly connected to several groups, it might be a DR in one group, a BDR in another group, and neither in a third group all at the same time.

Virtual Links

In some OSPF AS, it is not possible for an area to be directly connected to the backbone. In this case, you can create a virtual link through an intermediate area

to logically connect the area to the backbone. This is illustrated in the following example.

Figure 193 OSPF: Virtual Link

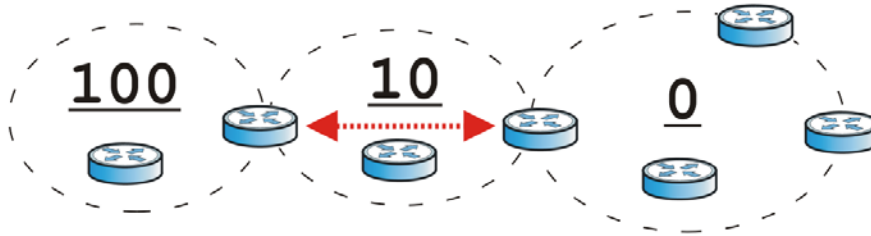

In this example, area 100 does not have a direct connection to the backbone. As a result, you should set up a virtual link on both ABR in area 10. The virtual link becomes the connection between area 100 and the backbone.

You cannot create a virtual link to a router in a different area.

OSPF Configuration

Follow these steps when you configure OSPF on the ZyWALL.

- 1 Enable OSPF.
- 2 Set up the OSPF areas.
- 3 Configure the appropriate interfaces. See [Section 11.3.1 on page 223](#).
- 4 Set up virtual links, as needed.

14.3.1 Configuring the OSPF Screen

Use the first OSPF screen to specify the OSPF router the ZyWALL uses in the OSPF AS and maintain the policies for redistribution. In addition, it provides a summary of OSPF areas, allows you to remove them, and opens the **OSPF Add/Edit** screen to add or edit them.

Click **Configuration > Network > Routing > OSPF** to open the following screen.

Figure 194 Configuration > Network > Routing > OSPF

The following table describes the labels in this screen. See [Section 14.3.2 on page 322](#) for more information as well.

Table 86 Configuration > Network > Routing Protocol > OSPF

LABEL	DESCRIPTION
OSPF Router ID	Select the 32-bit ID the ZyWALL uses in the OSPF AS. Default - the highest available IP address assigned to the interfaces is the ZyWALL's ID. User Defined - enter the ID (in IP address format) in the field that appears when you select User Defined .
Redistribute	
Active RIP	Select this to advertise routes that were learned from RIP. The ZyWALL advertises routes learned from RIP to Normal and NSSA areas but not to Stub areas.
Type	Select how OSPF calculates the cost associated with routing information from RIP. Choices are: Type 1 and Type 2 . Type 1 - cost = OSPF AS cost + external cost (Metric) Type 2 - cost = external cost (Metric); the OSPF AS cost is ignored.
Metric	Type the external cost for routes provided by RIP. The metric represents the "cost" of transmission for routing purposes. The way this is used depends on the Type field. This value is usually the average cost in the OSPF AS, and it can be between 1 and 16777214.
Active Static Route	Select this to advertise routes that were learned from static routes. The ZyWALL advertises routes learned from static routes to all types of areas.

Table 86 Configuration > Network > Routing Protocol > OSPF (continued)

LABEL	DESCRIPTION
Type	Select how OSPF calculates the cost associated with routing information from static routes. Choices are: Type 1 and Type 2 . Type 1 - cost = OSPF AS cost + external cost (Metric) Type 2 - cost = external cost (Metric); the OSPF AS cost is ignored.
Metric	Type the external cost for routes provided by static routes. The metric represents the "cost" of transmission for routing purposes. The way this is used depends on the Type field. This value is usually the average cost in the OSPF AS, and it can be between 1 and 16777214.
Area	This section displays information about OSPF areas in the ZyWALL.
Add	Click this to create a new OSPF area.
Edit	Double-click an entry or select it and click Edit to open a screen where you can modify the entry's settings.
Remove	To remove an entry, select it and click Remove . The ZyWALL confirms you want to remove it before doing so.
#	This field is a sequential value, and it is not associated with a specific area.
Area	This field displays the 32-bit ID for each area in IP address format.
Type	This field displays the type of area. This type is different from the Type field above.
Authentication	This field displays the default authentication method in the area.
Apply	Click this button to save your changes to the ZyWALL.
Reset	Click this button to return the screen to its last-saved settings.

14.3.2 OSPF Area Add/Edit Screen

The **OSPF Area Add/Edit** screen allows you to create a new area or edit an existing one. To access this screen, go to the **OSPF** summary screen (see [Section 14.3 on page 315](#)), and click either the **Add** icon or an **Edit** icon.

Figure 195 Configuration > Network > Routing > OSPF > Add

The following table describes the labels in this screen.

Table 87 Configuration > Network > Routing > OSPF > Add

LABEL	DESCRIPTION
Area ID	Type the unique, 32-bit identifier for the area in IP address format.
Type	Select the type of OSPF area. Normal - This area is a normal area. It has routing information about the OSPF AS and about networks outside the OSPF AS. Stub - This area is an stub area. It has routing information about the OSPF AS but not about networks outside the OSPF AS. It depends on a default route to send information outside the OSPF AS. NSSA - This area is a Not So Stubby Area (NSSA), per RFC 1587. It has routing information about the OSPF AS and networks that are outside the OSPF AS and are directly connected to the NSSA. It does not have information about other networks outside the OSPF AS.
Authentication	Select the default authentication method used in the area. This authentication protects the integrity, but not the confidentiality, of routing updates. None uses no authentication. Text uses a plain text password that is sent over the network (not very secure). MD5 uses an MD5 password and authentication ID (most secure).

Table 87 Configuration > Network > Routing > OSPF > Add (continued)

LABEL	DESCRIPTION
Text Authentication Key	This field is available if the Authentication is Text . Type the password for text authentication. The key can consist of alphanumeric characters and the underscore, and it can be up to 16 characters long.
MD5 Authentication ID	This field is available if the Authentication is MD5 . Type the default ID for MD5 authentication in the area. The ID can be between 1 and 255.
MD5 Authentication Key	This field is available if the Authentication is MD5 . Type the default password for MD5 authentication in the area. The password can consist of alphanumeric characters and the underscore, and it can be up to 16 characters long.
Virtual Link	This section is displayed if the Type is Normal . Create a virtual link if you want to connect a different area (that does not have a direct connection to the backbone) to the backbone. You should set up the virtual link on the ABR that is connected to the other area and on the ABR that is connected to the backbone.
Add	Click this to create a new virtual link.
Edit	Double-click an entry or select it and click Edit to open a screen where you can modify the entry's settings.
Remove	To remove an entry, select it and click Remove . The ZyWALL confirms you want to remove it before doing so.
#	This field is a sequential value, and it is not associated with a specific area.
Peer Router ID	This is the 32-bit ID (in IP address format) of the other ABR in the virtual link.
Authentication	This is the authentication method the virtual link uses. This authentication protects the integrity, but not the confidentiality, of routing updates. None uses no authentication. Text uses a plain text password that is sent over the network (not very secure). Hover your cursor over this label to display the password. MD5 uses an MD5 password and authentication ID (most secure). Hover your cursor over this label to display the authentication ID and key. Same as Area has the virtual link also use the Authentication settings above.
OK	Click OK to save your changes back to the ZyWALL.
Cancel	Click Cancel to exit this screen without saving.

14.3.3 Virtual Link Add/Edit Screen

The **Virtual Link Add/Edit** screen allows you to create a new virtual link or edit an existing one. When the OSPF add or edit screen (see [Section 14.3.2 on page](#)

322) has the Type set to Normal, a Virtual Link table displays. Click either the **Add** icon or an entry and the **Edit** icon to display a screen like the following.

Figure 196 Configuration > Network > Routing > OSPF > Add > Add

The following table describes the labels in this screen.

Table 88 Configuration > Network > Routing > OSPF > Add > Add

LABEL	DESCRIPTION
Peer Router ID	Enter the 32-bit ID (in IP address format) of the other ABR in the virtual link.
Authentication	Select the authentication method the virtual link uses. This authentication protects the integrity, but not the confidentiality, of routing updates. None uses no authentication. Text uses a plain text password that is sent over the network (not very secure). MD5 uses an MD5 password and authentication ID (most secure). Same as Area has the virtual link also use the Authentication settings above.
Text Authentication Key	This field is available if the Authentication is Text . Type the password for text authentication. The key can consist of alphanumeric characters and the underscore, and it can be up to 16 characters long.
MD5 Authentication ID	This field is available if the Authentication is MD5 . Type the default ID for MD5 authentication in the area. The ID can be between 1 and 255.
MD5 Authentication Key	This field is available if the Authentication is MD5 . Type the default password for MD5 authentication in the area. The password can consist of alphanumeric characters and the underscore, and it can be up to 16 characters long.
OK	Click OK to save your changes back to the ZyWALL.
Cancel	Click Cancel to exit this screen without saving.

14.4 Routing Protocol Technical Reference

Here is more detailed information about RIP and OSPF.

Authentication Types

Authentication is used to guarantee the integrity, but not the confidentiality, of routing updates. The transmitting router uses its key to encrypt the original message into a smaller message, and the smaller message is transmitted with the original message. The receiving router uses its key to decrypt the received message and then verifies that it matches the smaller message sent with it. If the received message is verified, then the receiving router accepts the updated routing information. The transmitting and receiving routers must have the same key.

The ZyWALL supports three types of authentication for RIP and OSPF routing protocols:

- **None** - no authentication is used.
- **Text** - authentication using a plain text password, and the (unencrypted) password is sent over the network. This method is usually used temporarily to prevent network problems.
- **MD5** - authentication using an MD5 password and authentication ID.

MD5 is an authentication method that produces a 128-bit checksum, called a message-digest, for each packet. It also includes an authentication ID, which can be set to any value between 1 and 255. The ZyWALL only accepts packets if these conditions are satisfied.

- The packet's authentication ID is the same as the authentication ID of the interface that received it.
- The packet's message-digest is the same as the one the ZyWALL calculates using the MD5 password.

For RIP, authentication is not available in RIP version 1. In RIP version 2, you can only select one authentication type for all interfaces. For OSPF, the ZyWALL supports a default authentication type by area. If you want to use this default in an interface or virtual link, you set the associated **Authentication Type** field to **Same as Area**. As a result, you only have to update the authentication information for the area to update the authentication type used by these interfaces and virtual links. Alternatively, you can override the default in any interface or virtual link by selecting a specific authentication method. Please see the respective interface sections for more information.

15.1 Zones Overview

Set up zones to configure network security and network policies in the ZyWALL. A zone is a group of interfaces and/or VPN tunnels. The ZyWALL uses zones instead of interfaces in many security and policy settings, such as firewall rules, Anti-X, and remote management.

Zones cannot overlap. Each Ethernet interface, VLAN interface, bridge interface, PPPoE/PPTP interface and VPN tunnel can be assigned to at most one zone. Virtual interfaces are automatically assigned to the same zone as the interface on which they run.

Figure 197 Example: Zones

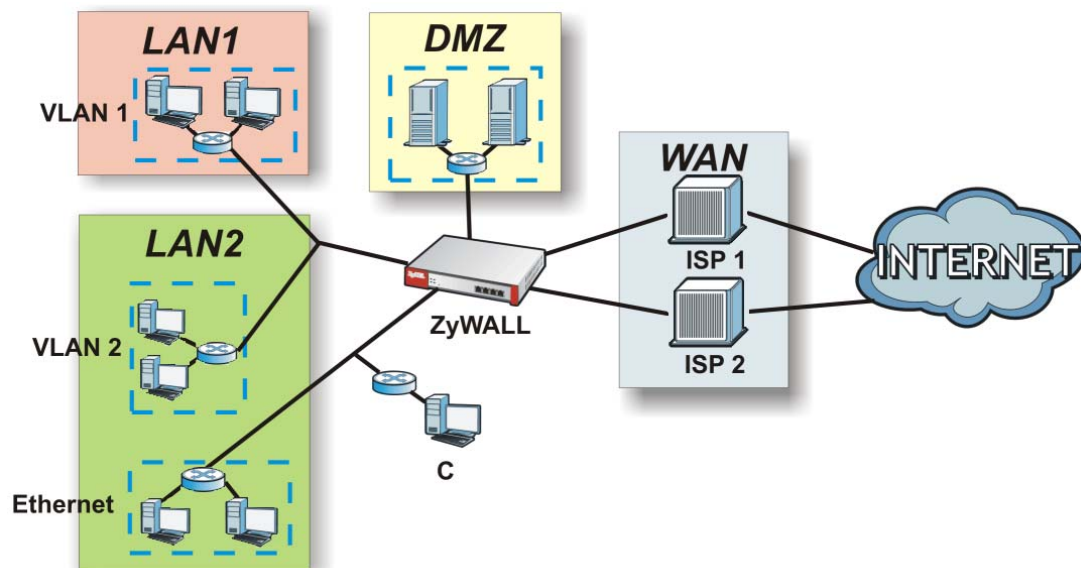

15.1.1 What You Can Do in this Chapter

Use the **Zone** screens (see [Section 15.2 on page 329](#)) to manage the ZyWALL's zones.

15.1.2 What You Need to Know

Effects of Zones on Different Types of Traffic

Zones effectively divide traffic into three types--intra-zone traffic, inter-zone traffic, and extra-zone traffic--which are affected differently by zone-based security and policy settings.

Intra-zone Traffic

- Intra-zone traffic is traffic between interfaces or VPN tunnels in the same zone. For example, in [Figure 197 on page 327](#), traffic between VLAN 2 and the Ethernet is intra-zone traffic.
- In each zone, you can either allow or prohibit all intra-zone traffic. For example, in [Figure 197 on page 327](#), you might allow intra-zone traffic in the LAN zone but prohibit it in the WAN zone.
- You can also set up firewall rules to control intra-zone traffic (for example, DMZ-to-DMZ), but many other types of zone-based security and policy settings do not affect intra-zone traffic.

Inter-zone Traffic

Inter-zone traffic is traffic between interfaces or VPN tunnels in different zones. For example, in [Figure 197 on page 327](#), traffic between VLAN 1 and the Internet is inter-zone traffic. This is the normal case when zone-based security and policy settings apply.

Extra-zone Traffic

- Extra-zone traffic is traffic to or from any interface or VPN tunnel that is not assigned to a zone. For example, in [Figure 197 on page 327](#), traffic to or from computer C is extra-zone traffic.
- Some zone-based security and policy settings may apply to extra-zone traffic, especially if you can set the zone attribute in them to **Any** or **All**. See the specific feature for more information.

Finding Out More

- See [Section 6.5.7 on page 98](#) for related information on these screens.
- See [Section 7.1 on page 107](#) for an example of configuring Ethernet interfaces, port groups, and zones.

15.2 The Zone Screen

The **Zone** screen provides a summary of all zones. In addition, this screen allows you to add, edit, and remove zones. To access this screen, click **Configuration > Network > Zone**.

Figure 198 Configuration > Network > Zone (USG 20W)

The screenshot shows the 'Zone' configuration screen. It is divided into two main sections: 'User Configuration' and 'System Default'. Both sections contain a table with columns for '#', 'Name', 'Block Intra-zone', and 'Member'. The 'User Configuration' section has one entry: 'IPSec_VPN' with 'Block Intra-zone' set to 'yes'. The 'System Default' section has six entries: 'LAN1', 'LAN2', 'WLAN', 'WAN', 'DMZ', and 'SSL_VPN', each with their respective 'Block Intra-zone' and 'Member' values.

#	Name	Block Intra-zone	Member
1	IPSec_VPN	yes	

#	Name	Block Intra-zone	Member
1	LAN1	no	lan1
2	LAN2	no	lan2
3	WLAN	no	wlan-1-1
4	WAN	yes	wan1,wan1_ppp
5	DMZ	yes	dmz
6	SSL_VPN	yes	

The following table describes the labels in this screen.

Table 89 Configuration > Network > Zone

LABEL	DESCRIPTION
User Configuration / System Default	The ZyWALL comes with pre-configured System Default zones that you cannot delete. You can create your own User Configuration zones
Add	Click this to create a new, user-configured zone.
Edit	Double-click an entry or select it and click Edit to open a screen where you can modify the entry's settings.
Remove	To remove a user-configured trunk, select it and click Remove . The ZyWALL confirms you want to remove it before doing so.
Object References	Select an entry and click Object References to open a screen that shows which settings use the entry. See Section 11.3.2 on page 232 for an example.
#	This field is a sequential value, and it is not associated with any interface.
Name	This field displays the name of the zone.
Block Intra-zone	This field indicates whether or not the ZyWALL blocks network traffic between members in the zone.
Member	This field displays the names of the interfaces that belong to each zone.

15.3 Zone Edit

The **Zone Edit** screen allows you to add or edit a zone. To access this screen, go to the **Zone** screen (see [Section 15.2 on page 329](#)), and click the **Add** icon or an **Edit** icon.

Figure 199 Network > Zone > Add

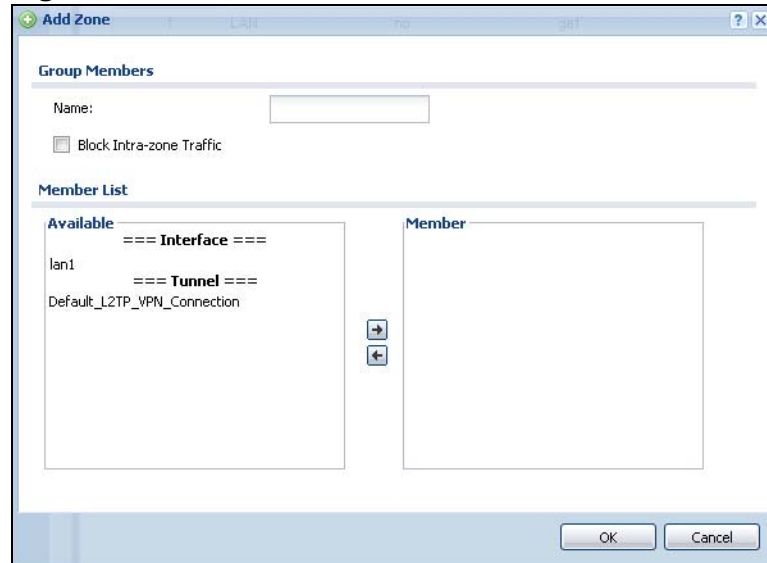

The following table describes the labels in this screen.

Table 90 Network > Zone > Edit

LABEL	DESCRIPTION
Name	For a system default zone, the name is read only. For a user-configured zone, type the name used to refer to the zone. You may use 1-31 alphanumeric characters, underscores(_), or dashes (-), but the first character cannot be a number. This value is case-sensitive.
Block Intra-zone Traffic	Select this check box to block network traffic between members in the zone.
Member List	Available lists the interfaces and VPN tunnels that do not belong to any zone. Select the interfaces and VPN tunnels that you want to add to the zone you are editing, and click the right arrow button to add them. Member lists the interfaces and VPN tunnels that belong to the zone. Select any interfaces that you want to remove from the zone, and click the left arrow button to remove them.
OK	Click OK to save your customized settings and exit this screen.
Cancel	Click Cancel to exit this screen without saving.

16.1 DDNS Overview

Dynamic DNS (DDNS) services let you use a domain name with a dynamic IP address.

16.1.1 What You Can Do in this Chapter

- Use the **DDNS** screen (see [Section 16.2 on page 332](#)) to view a list of the configured DDNS domain names and their details.
- Use the **DDNS Add/Edit** screen (see [Section 16.2.1 on page 334](#)) to add a domain name to the ZyWALL or to edit the configuration of an existing domain name.

16.1.2 What You Need to Know

DNS maps a domain name to a corresponding IP address and vice versa. Similarly, dynamic DNS maps a domain name to a dynamic IP address. As a result, anyone can use the domain name to contact you (in NetMeeting, CU-SeeMe, etc.) or to access your FTP server or Web site, regardless of the current IP address.

Note: You must have a public WAN IP address to use Dynamic DNS.

You must set up a dynamic DNS account with a supported DNS service provider before you can use Dynamic DNS services with the ZyWALL. When registration is complete, the DNS service provider gives you a password or key. At the time of writing, the ZyWALL supports the following DNS service providers. See the listed websites for details about the DNS services offered by each.

Table 91 DDNS Service Providers

PROVIDER	SERVICE TYPES SUPPORTED	WEBSITE
DynDNS	Dynamic DNS, Static DNS, and Custom DNS	www.dyndns.com
Dynu	Basic, Premium	www.dynu.com
No-IP	No-IP	www.no-ip.com
Peanut Hull	Peanut Hull	www.oray.cn
3322	3322 Dynamic DNS, 3322 Static DNS	www.3322.org

Note: Record your DDNS account's user name, password, and domain name to use to configure the ZyWALL.

After, you configure the ZyWALL, it automatically sends updated IP addresses to the DDNS service provider, which helps redirect traffic accordingly.

Finding Out More

See [Section 6.5.8 on page 98](#) for related information on these screens.

16.2 The DDNS Screen

The **DDNS** screen provides a summary of all DDNS domain names and their configuration. In addition, this screen allows you to add new domain names, edit the configuration for existing domain names, and delete domain names. Click **Configuration > Network > DDNS** to open the following screen.

Figure 200 Configuration > Network > DDNS

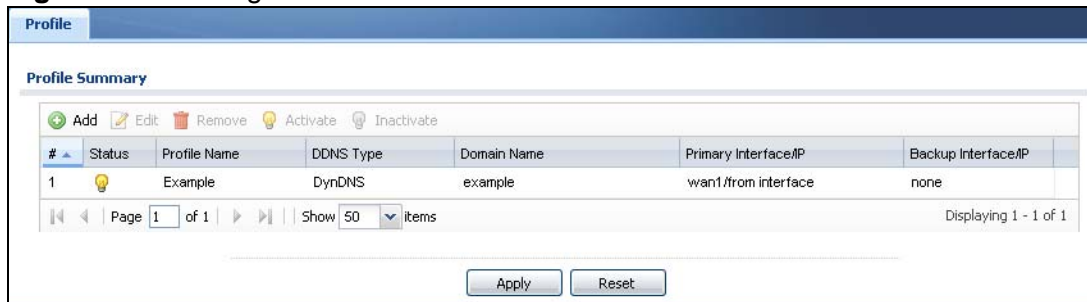

The following table describes the labels in this screen.

Table 92 Configuration > Network > DDNS

LABEL	DESCRIPTION
Add	Click this to create a new entry.
Edit	Double-click an entry or select it and click Edit to open a screen where you can modify the entry's settings.
Remove	To remove an entry, select it and click Remove . The ZyWALL confirms you want to remove it before doing so.
Activate	To turn on an entry, select it and click Activate .
Inactivate	To turn off an entry, select it and click Inactivate .
#	This is the number of an individual DDNS profile.
Status	This icon is lit when the entry is active and dimmed when the entry is inactive.
Profile Name	This field displays the descriptive profile name for this entry.
DDNS Type	This field displays which DDNS service you are using.
Domain Name	This field displays each domain name the ZyWALL can route.

Table 92 Configuration > Network > DDNS (continued)

LABEL	DESCRIPTION
Primary Interface/IP	<p>This field displays the interface to use for updating the IP address mapped to the domain name followed by how the ZyWALL determines the IP address for the domain name.</p> <p>from interface - The IP address comes from the specified interface.</p> <p>auto detected -The DDNS server checks the source IP address of the packets from the ZyWALL for the IP address to use for the domain name.</p> <p>custom - The IP address is static.</p>
Backup Interface/IP	<p>This field displays the alternate interface to use for updating the IP address mapped to the domain name followed by how the ZyWALL determines the IP address for the domain name. The ZyWALL uses the backup interface and IP address when the primary interface is disabled, its link is down or its connectivity check fails.</p> <p>from interface - The IP address comes from the specified interface.</p> <p>auto detected -The DDNS server checks the source IP address of the packets from the ZyWALL for the IP address to use for the domain name.</p> <p>custom - The IP address is static.</p>
Apply	Click this button to save your changes to the ZyWALL.
Reset	Click this button to return the screen to its last-saved settings.

16.2.1 The Dynamic DNS Add/Edit Screen

The **DDNS Add/Edit** screen allows you to add a domain name to the ZyWALL or to edit the configuration of an existing domain name. Click **Configuration > Network > DDNS** and then an **Add** or **Edit** icon to open this screen.

Figure 201 Configuration > Network > DDNS > Add

The following table describes the labels in this screen.

Table 93 Configuration > Network > DDNS > Add

LABEL	DESCRIPTION
Show Advance Settings / Hide Advance Settings	Click this button to display a greater or lesser number of configuration fields.
Enable DDNS Profile	Select this check box to use this DDNS entry.
Profile Name	When you are adding a DDNS entry, type a descriptive name for this DDNS entry in the ZyWALL. You may use 1-31 alphanumeric characters, underscores(_), or dashes (-), but the first character cannot be a number. This value is case-sensitive. This field is read-only when you are editing an entry.
DDNS Type	Select the type of DDNS service you are using.

Table 93 Configuration > Network > DDNS > Add (continued)

LABEL	DESCRIPTION
Username	<p>Type the user name used when you registered your domain name. You can use up to 31 alphanumeric characters and the underscore. Spaces are not allowed.</p> <p>For a Dynu DDNS entry, this user name is the one you use for logging into the service, not the name recorded in your personal information in the Dynu website.</p>
Password	Type the password provided by the DDNS provider. You can use up to 64 alphanumeric characters and the underscore. Spaces are not allowed.
DDNS Settings	
Domain name	Type the domain name you registered. You can use up to 255 characters.
Primary Binding Address	Use these fields to set how the ZyWALL determines the IP address that is mapped to your domain name in the DDNS server. The ZyWALL uses the Backup Binding Address if the interface specified by these settings is not available.
Interface	Select the interface to use for updating the IP address mapped to the domain name. Select Any to let the domain name be used with any interface.
IP Address	<p>The options available in this field vary by DDNS provider.</p> <p>Interface -The ZyWALL uses the IP address of the specified interface. This option appears when you select a specific interface in the Primary Binding Address Interface field.</p> <p>Auto - If the interface has a dynamic IP address, the DDNS server checks the source IP address of the packets from the ZyWALL for the IP address to use for the domain name. You may want to use this if there are one or more NAT routers between the ZyWALL and the DDNS server.</p> <p>Note: The ZyWALL may not determine the proper IP address if there is an HTTP proxy server between the ZyWALL and the DDNS server.</p> <p>Custom - If you have a static IP address, you can select this to use it for the domain name. The ZyWALL still sends the static IP address to the DDNS server.</p>
Custom IP	This field is only available when the IP Address is Custom . Type the IP address to use for the domain name.
Backup Binding Address	Use these fields to set an alternate interface to map the domain name to when the interface specified by the Primary Binding Interface settings is not available.
Interface	Select the interface to use for updating the IP address mapped to the domain name. Select Any to let the domain name be used with any interface. Select None to not use a backup address.

Table 93 Configuration > Network > DDNS > Add (continued)

LABEL	DESCRIPTION
IP Address	<p>The options available in this field vary by DDNS provider.</p> <p>Interface -The ZyWALL uses the IP address of the specified interface. This option appears when you select a specific interface in the Backup Binding Address Interface field.</p> <p>Auto -The DDNS server checks the source IP address of the packets from the ZyWALL for the IP address to use for the domain name. You may want to use this if there are one or more NAT routers between the ZyWALL and the DDNS server.</p> <p>Note: The ZyWALL may not determine the proper IP address if there is an HTTP proxy server between the ZyWALL and the DDNS server.</p> <p>Custom - If you have a static IP address, you can select this to use it for the domain name. The ZyWALL still sends the static IP address to the DDNS server.</p>
Custom IP	This field is only available when the IP Address is Custom . Type the IP address to use for the domain name.
Enable Wildcard	<p>This option is only available with a DynDNS account.</p> <p>Enable the wildcard feature to alias subdomains to be aliased to the same IP address as your (dynamic) domain name. This feature is useful if you want to be able to use, for example, www.yourhost.dyndns.org and still reach your hostname.</p>
Mail Exchanger	<p>This option is only available with a DynDNS account.</p> <p>DynDNS can route e-mail for your domain name to a mail server (called a mail exchanger). For example, DynDNS routes e-mail for john-doe@yourhost.dyndns.org to the host record specified as the mail exchanger.</p> <p>If you are using this service, type the host record of your mail server here. Otherwise leave the field blank.</p> <p>See www.dyndns.org for more information about mail exchangers.</p>
Backup Mail Exchanger	<p>This option is only available with a DynDNS account.</p> <p>Select this check box if you are using DynDNS's backup service for e-mail. With this service, DynDNS holds onto your e-mail if your mail server is not available. Once your mail server is available again, the DynDNS server delivers the mail to you. See www.dyndns.org for more information about this service.</p>
OK	Click OK to save your changes back to the ZyWALL.
Cancel	Click Cancel to exit this screen without saving.

17.1 NAT Overview

NAT (Network Address Translation - NAT, RFC 1631) is the translation of the IP address of a host in a packet. For example, the source address of an outgoing packet, used within one network is changed to a different IP address known within another network. Use Network Address Translation (NAT) to make computers on a private network behind the ZyWALL available outside the private network. If the ZyWALL has only one public IP address, you can make the computers in the private network available by using ports to forward packets to the appropriate private IP address.

Suppose you want to assign ports 21-25 to one FTP, Telnet and SMTP server (**A** in the example), port 80 to another (**B** in the example) and assign a default server IP address of 192.168.1.35 to a third (**C** in the example). You assign the LAN IP addresses and the ISP assigns the WAN IP address. The NAT network appears as a single host on the Internet.

Figure 202 Multiple Servers Behind NAT Example

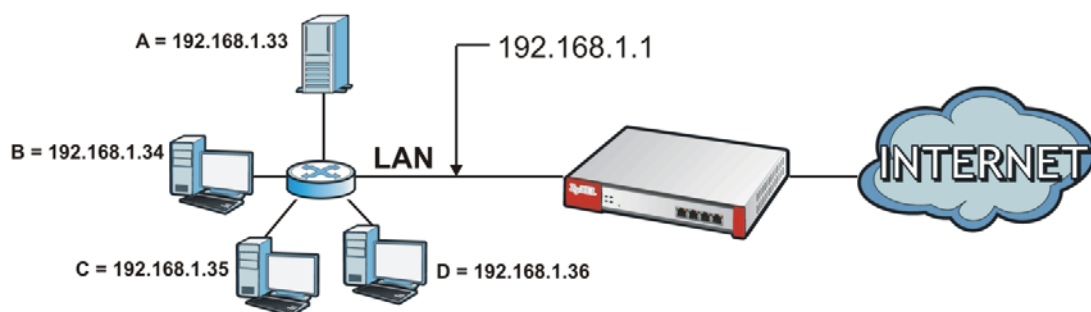

17.1.1 What You Can Do in this Chapter

Use the **NAT** screens (see [Section 17.2 on page 338](#)) to view and manage the list of NAT rules and see their configuration details. You can also create new NAT rules and edit or delete existing ones.

17.1.2 What You Need to Know

NAT is also known as virtual server, port forwarding, or port translation.

Finding Out More

- See [Section 6.5.9 on page 98](#) for related information on these screens.
- See [Section 17.3 on page 343](#) for technical background information related to these screens.
- See [Section 7.9.2 on page 133](#) for an example of how to configure NAT to allow H.323 traffic from the WAN to the LAN.
- See [Section 7.10.2 on page 137](#) for an example of how to configure NAT to allow web traffic from the WAN to a server on the DMZ.
- See [Section 7.11.3 on page 142](#) for an example of how to configure NAT to allow SIP traffic from the WAN to an IPPBX or SIP server on the DMZ.

17.2 The NAT Screen

The **NAT** summary screen provides a summary of all NAT rules and their configuration. In addition, this screen allows you to create new NAT rules and edit and delete existing NAT rules. To access this screen, login to the Web Configurator and click **Configuration > Network > NAT**. The following screen appears, providing a summary of the existing NAT rules.

Figure 203 Configuration > Network > NAT

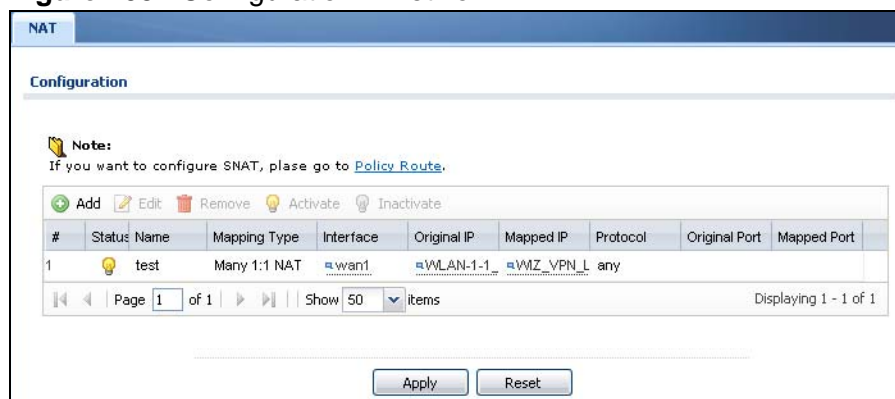

The following table describes the labels in this screen.

Table 94 Configuration > Network > NAT

LABEL	DESCRIPTION
Add	Click this to create a new entry.
Edit	Double-click an entry or select it and click Edit to open a screen where you can modify the entry's settings.

Table 94 Configuration > Network > NAT (continued)

LABEL	DESCRIPTION
Remove	To remove an entry, select it and click Remove . The ZyWALL confirms you want to remove it before doing so.
Activate	To turn on an entry, select it and click Activate .
Inactivate	To turn off an entry, select it and click Inactivate .
#	This field is a sequential value, and it is not associated with a specific entry.
Status	This icon is lit when the entry is active and dimmed when the entry is inactive.
Name	This field displays the name of the entry.
Mapping Type	This field displays what kind of NAT this entry performs: Virtual Server , 1:1 NAT , or Many 1:1 NAT .
Interface	This field displays the interface on which packets for the NAT entry are received.
Original IP	This field displays the original destination IP address (or address object) of traffic that matches this NAT entry. It displays any if there is no restriction on the original destination IP address.
Mapped IP	This field displays the new destination IP address for the packet.
Protocol	This field displays the service used by the packets for this NAT entry. It displays any if there is no restriction on the services.
Original Port	This field displays the original destination port(s) of packets for the NAT entry. This field is blank if there is no restriction on the original destination port.
Mapped Port	This field displays the new destination port(s) for the packet. This field is blank if there is no restriction on the original destination port.
Apply	Click this button to save your changes to the ZyWALL.
Reset	Click this button to return the screen to its last-saved settings.

17.2.1 The NAT Add/Edit Screen

The **NAT Add/Edit** screen lets you create new NAT rules and edit existing ones. To open this window, open the **NAT** summary screen. (See [Section 17.2 on page 338.](#)) Then, click on an **Add** icon or **Edit** icon to open the following screen.

Figure 204 Configuration > Network > NAT > Add

The following table describes the labels in this screen.

Table 95 Configuration > Network > NAT > Add

LABEL	DESCRIPTION
Create new Object	Use to configure any new settings objects that you need to use in this screen.
Enable Rule	Use this option to turn the NAT rule on or off.
Rule Name	Type in the name of the NAT rule. The name is used to refer to the NAT rule. You may use 1-31 alphanumeric characters, underscores(_), or dashes (-), but the first character cannot be a number. This value is case-sensitive.

Table 95 Configuration > Network > NAT > Add (continued)

LABEL	DESCRIPTION
Classification	<p>Select what kind of NAT this rule is to perform.</p> <p>Virtual Server - This makes computers on a private network behind the ZyWALL available to a public network outside the ZyWALL (like the Internet).</p> <p>1:1 NAT - If the private network server will initiate sessions to the outside clients, select this to have the ZyWALL translate the source IP address of the server's outgoing traffic to the same public IP address that the outside clients use to access the server.</p> <p>Many 1:1 NAT - If you have a range of private network servers that will initiate sessions to the outside clients and a range of public IP addresses, select this to have the ZyWALL translate the source IP address of each server's outgoing traffic to the same one of the public IP addresses that the outside clients use to access the server. The private and public ranges must have the same number of IP addresses.</p> <p>One many 1:1 NAT rule works like multiple 1:1 NAT rules, but it eases configuration effort since you only create one rule.</p>
Incoming Interface	<p>Select the interface on which packets for the NAT rule must be received. It can be an Ethernet, VLAN, bridge, or PPPoE/PPTP interface.</p>
Original IP	<p>Specify the destination IP address of the packets received by this NAT rule's specified incoming interface.</p> <p>any - Select this to use all of the incoming interface's IP addresses including dynamic addresses or those of any virtual interfaces built upon the selected incoming interface.</p> <p>User Defined - Select this to manually enter an IP address in the User Defined field. For example, you could enter a static public IP assigned by the ISP without having to create a virtual interface for it.</p> <p>Host address - select a host address object to use the IP address it specifies. The list also includes address objects based on interface IPs. So for example you could select an address object based on a WAN interface even if it has a dynamic IP address.</p>
User Defined Original IP	<p>This field is available if Original IP is User Defined. Type the destination IP address that this NAT rule supports.</p>
Original IP Subnet/Range	<p>This field displays for Many 1:1 NAT. Select the destination IP address subnet or IP address range that this NAT rule supports. The original and mapped IP address subnets or ranges must have the same number of IP addresses.</p>
Mapped IP	<p>Select to which translated destination IP address this NAT rule forwards packets.</p> <p>User Defined - this NAT rule supports a specific IP address, specified in the User Defined field.</p> <p>HOST address - the drop-down box lists all the HOST address objects in the ZyWALL. If you select one of them, this NAT rule supports the IP address specified by the address object.</p>
User Defined Original IP	<p>This field is available if Mapped IP is User Defined. Type the translated destination IP address that this NAT rule supports.</p>

Table 95 Configuration > Network > NAT > Add (continued)

LABEL	DESCRIPTION
Mapped IP Subnet/Range	This field displays for Many 1:1 NAT . Select to which translated destination IP address subnet or IP address range this NAT rule forwards packets. The original and mapped IP address subnets or ranges must have the same number of IP addresses.
Port Mapping Type	Use the drop-down list box to select how many original destination ports this NAT rule supports for the selected destination IP address (Original IP). Choices are: Any - this NAT rule supports all the destination ports. Port - this NAT rule supports one destination port. Ports - this NAT rule supports a range of destination ports. You might use a range of destination ports for unknown services or when one server supports more than one service. See Appendix B on page 799 for some common port numbers.
Protocol Type	This field is available if Mapping Type is Port or Ports . Select the protocol (TCP , UDP , or Any) used by the service requesting the connection.
Original Port	This field is available if Mapping Type is Port . Enter the original destination port this NAT rule supports.
Mapped Port	This field is available if Mapping Type is Port . Enter the translated destination port if this NAT rule forwards the packet.
Original Start Port	This field is available if Mapping Type is Ports . Enter the beginning of the range of original destination ports this NAT rule supports.
Original End Port	This field is available if Mapping Type is Ports . Enter the end of the range of original destination ports this NAT rule supports.
Mapped Start Port	This field is available if Mapping Type is Ports . Enter the beginning of the range of translated destination ports if this NAT rule forwards the packet.
Mapped End Port	This field is available if Mapping Type is Ports . Enter the end of the range of translated destination ports if this NAT rule forwards the packet. The original port range and the mapped port range must be the same size.
Enable NAT Loopback	Enable NAT loopback to allow users connected to any interface (instead of just the specified Incoming Interface) to use the NAT rule's specified Original IP address to access the Mapped IP device. For users connected to the same interface as the Mapped IP device, the ZyWALL uses that interface's IP address as the source address for the traffic it sends from the users to the Mapped IP device. For example, if you configure a NAT rule to forward traffic from the WAN to a LAN server, enabling NAT loopback allows users connected to other interfaces to also access the server. For LAN users, the ZyWALL uses the LAN interface's IP address as the source address for the traffic it sends to the LAN server. See NAT Loopback on page 343 for more details. If you do not enable NAT loopback, this NAT rule only applies to packets received on the rule's specified incoming interface.

Table 95 Configuration > Network > NAT > Add (continued)

LABEL	DESCRIPTION
Firewall	<p>By default the firewall blocks incoming connections from external addresses. After you configure your NAT rule settings, click the Firewall link to configure a firewall rule to allow the NAT rule's traffic to come in.</p> <p>The ZyWALL checks NAT rules before it applies To-ZyWALL firewall rules, so To-ZyWALL firewall rules do not apply to traffic that is forwarded by NAT rules. The ZyWALL still checks other firewall rules according to the source IP address and mapped IP address.</p>
OK	Click OK to save your changes back to the ZyWALL.
Cancel	Click Cancel to return to the NAT summary screen without creating the NAT rule (if it is new) or saving any changes (if it already exists).

17.3 NAT Technical Reference

Here is more detailed information about NAT on the ZyWALL.

NAT Loopback

Suppose a NAT 1:1 rule maps a public IP address to the private IP address of a LAN SMTP e-mail server to give WAN users access. NAT loopback allows other users to also use the rule's original IP to access the mail server.

For example, a LAN user's computer at IP address 192.168.1.89 queries a public DNS server to resolve the SMTP server's domain name (xxx.LAN-SMTP.com in this example) and gets the SMTP server's mapped public IP address of 1.1.1.1.

Figure 205 LAN Computer Queries a Public DNS Server

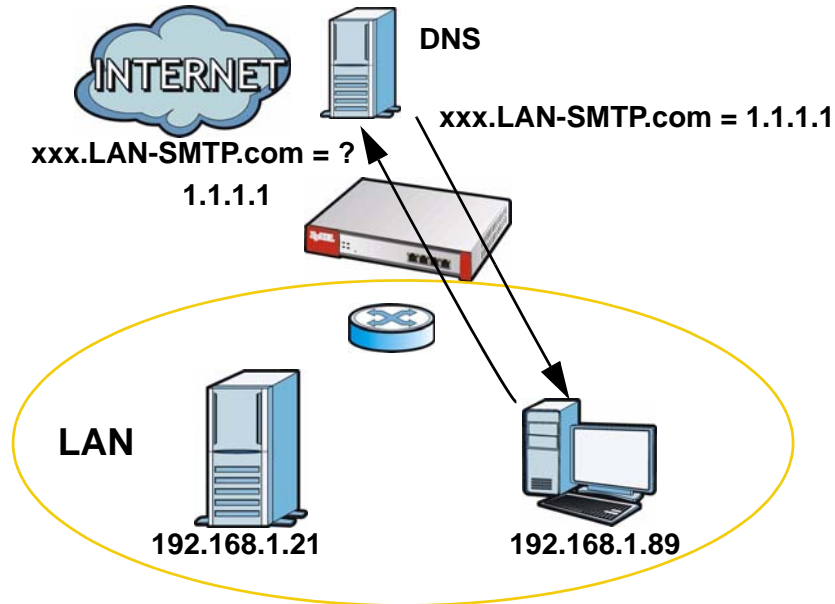

The LAN user's computer then sends traffic to IP address 1.1.1.1. NAT loopback uses the IP address of the ZyWALL's LAN interface (192.168.1.1) as the source address of the traffic going from the LAN users to the LAN SMTP server.

Figure 206 LAN to LAN Traffic

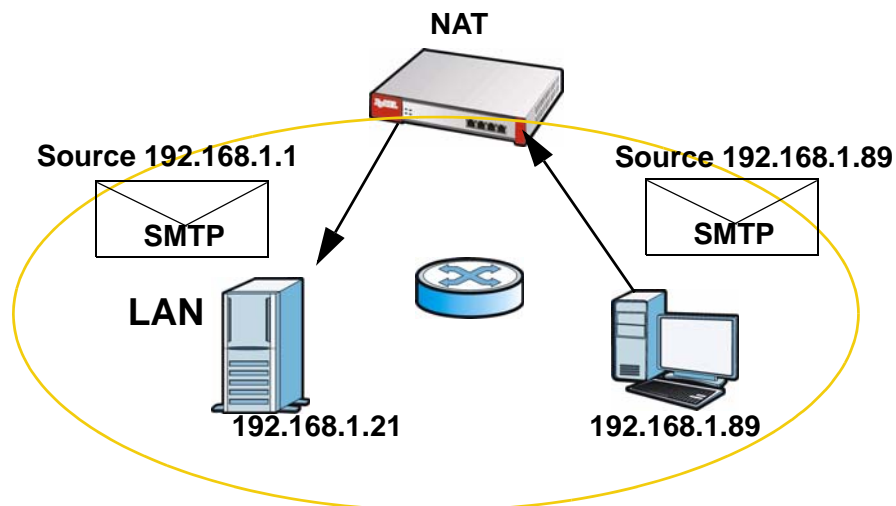

The LAN SMTP server replies to the ZyWALL's LAN IP address and the ZyWALL changes the source address to 1.1.1.1 before sending it to the LAN user. The return traffic's source matches the original destination address (1.1.1.1). If the

SMTP server replied directly to the LAN user without the traffic going through NAT, the source would not match the original destination address which would cause the LAN user's computer to shut down the session.

Figure 207 LAN to LAN Return Traffic

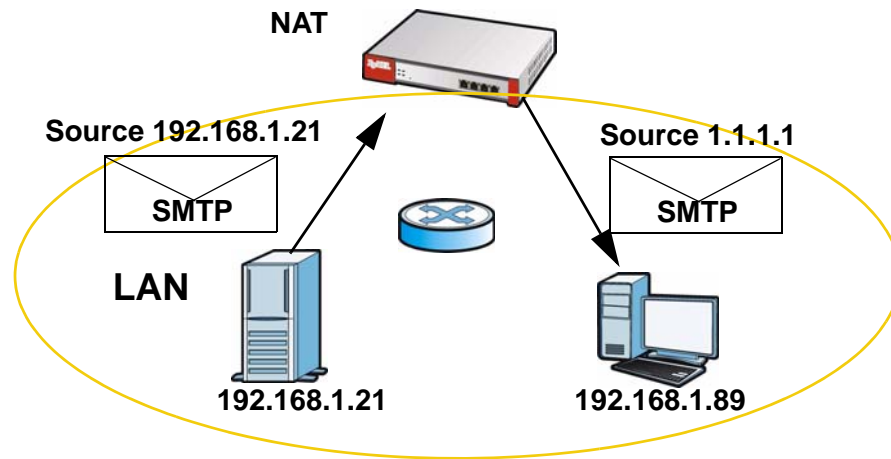

HTTP Redirect

18.1 Overview

HTTP redirect forwards the client's HTTP request (except HTTP traffic destined for the ZyWALL) to a web proxy server. In the following example, proxy server **A** is connected to the **DMZ** interface. When a client connected to the **LAN1** zone wants to open a web page, its HTTP request is redirected to proxy server **A** first. If proxy server **A** cannot find the web page in its cache, a policy route allows it to access the Internet to get them from a server. Proxy server **A** then forwards the response to the client.

Figure 208 HTTP Redirect Example

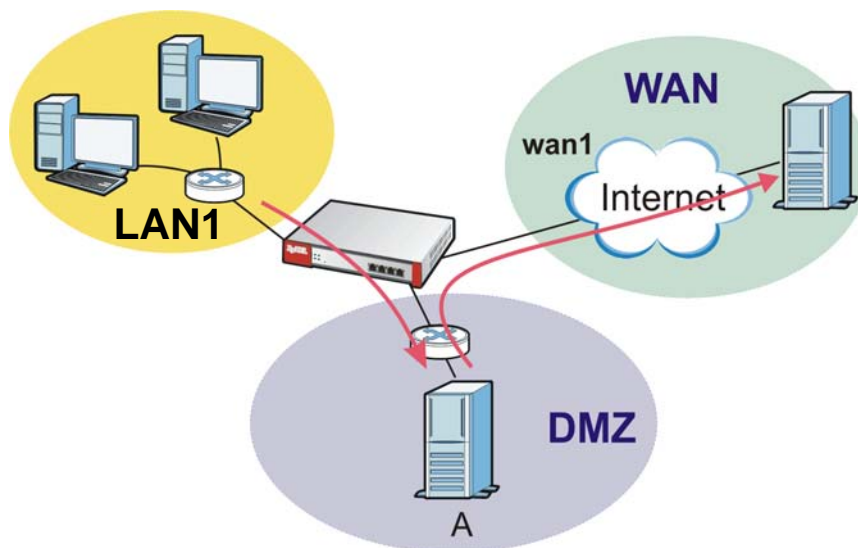

18.1.1 What You Can Do in this Chapter

Use the **HTTP Redirect** screens (see [Section 18.2 on page 349](#)) to display and edit the HTTP redirect rules.

18.1.2 What You Need to Know

Web Proxy Server

A proxy server helps client devices make indirect requests to access the Internet or outside network resources/services. A proxy server can act as a firewall or an ALG (application layer gateway) between the private network and the Internet or other networks. It also keeps hackers from knowing internal IP addresses.

A client connects to a web proxy server each time he/she wants to access the Internet. The web proxy provides caching service to allow quick access and reduce network usage. The proxy checks its local cache for the requested web resource first. If it is not found, the proxy gets it from the specified server and forwards the response to the client.

HTTP Redirect, Firewall and Policy Route

With HTTP redirect, the relevant packet flow for HTTP traffic is:

- 1 Firewall
- 2 HTTP Redirect
- 3 Policy Route

Even if you set a policy route to the same incoming interface and service as a HTTP redirect rule, the ZyWALL checks the HTTP redirect rules first and forwards HTTP traffic to a proxy server if matched. You need to make sure there is no firewall rule(s) blocking the HTTP requests from the client to the proxy server.

You also need to manually configure a policy route to forward the HTTP traffic from the proxy server to the Internet. To make the example in [Figure 208 on page 347](#) work, make sure you have the following settings.

For HTTP traffic between **lan1** and **dmz**:

- a from LAN1 to WAN firewall rule (default) to allow HTTP requests from **lan1** to **dmz**. Responses to this request are allowed automatically.
- a HTTP redirect rule to forward HTTP traffic from **lan1** to proxy server **A**.

For HTTP traffic between **dmz** and **wan1**:

- a from DMZ to WAN firewall rule (default) to allow HTTP requests from **dmz** to **wan1**. Responses to these requests are allowed automatically.
- a policy route to forward HTTP traffic from proxy server **A** to the Internet.

Finding Out More

See [Section 6.5.10 on page 99](#) for related information on these screens.

18.2 The HTTP Redirect Screen

To configure redirection of a HTTP request to a proxy server, click **Configuration > Network > HTTP Redirect**. This screen displays the summary of the HTTP redirect rules.

Note: You can configure up to one HTTP redirect rule for each (incoming) interface.

Figure 209 Configuration > Network > HTTP Redirect



The following table describes the labels in this screen.

Table 96 Configuration > Network > HTTP Redirect

LABEL	DESCRIPTION
Add	Click this to create a new entry.
Edit	Double-click an entry or select it and click Edit to open a screen where you can modify the entry's settings.
Remove	To remove an entry, select it and click Remove . The ZyWALL confirms you want to remove it before doing so.
Activate	To turn on an entry, select it and click Activate .
Inactivate	To turn off an entry, select it and click Inactivate .
#	This field is a sequential value, and it is not associated with a specific entry.
Status	This icon is lit when the entry is active and dimmed when the entry is inactive.
Name	This is the descriptive name of a rule.
Interface	This is the interface on which the request must be received.
Proxy Server	This is the IP address of the proxy server.
Port	This is the service port number used by the proxy server.
Apply	Click Apply to save your changes back to the ZyWALL.
Reset	Click Reset to return the screen to its last-saved settings.

18.2.1 The HTTP Redirect Edit Screen

Click **Network > HTTP Redirect** to open the **HTTP Redirect** screen. Then click the **Add** or **Edit** icon to open the **HTTP Redirect Edit** screen where you can configure the rule.

Figure 210 Network > HTTP Redirect > Edit

The following table describes the labels in this screen.

Table 97 Network > HTTP Redirect > Edit

LABEL	DESCRIPTION
Enable	Use this option to turn the HTTP redirect rule on or off.
Name	Enter a name to identify this rule. You may use 1-31 alphanumeric characters, underscores(_), or dashes (-), but the first character cannot be a number. This value is case-sensitive.
Interface	Select the interface on which the HTTP request must be received for the ZyWALL to forward it to the specified proxy server.
Proxy Server	Enter the IP address of the proxy server.
Port	Enter the port number that the proxy server uses.
OK	Click OK to save your changes back to the ZyWALL.
Cancel	Click Cancel to exit this screen without saving.

19.1 ALG Overview

Application Layer Gateway (ALG) allows the following applications to operate properly through the ZyWALL's NAT.

- SIP - Session Initiation Protocol (SIP) - An application-layer protocol that can be used to create voice and multimedia sessions over Internet.
- H.323 - A teleconferencing protocol suite that provides audio, data and video conferencing.
- FTP - File Transfer Protocol - an Internet file transfer service.

The following example shows SIP signaling (1) and audio (2) sessions between SIP clients **A** and **B** and the SIP server.

Figure 211 SIP ALG Example

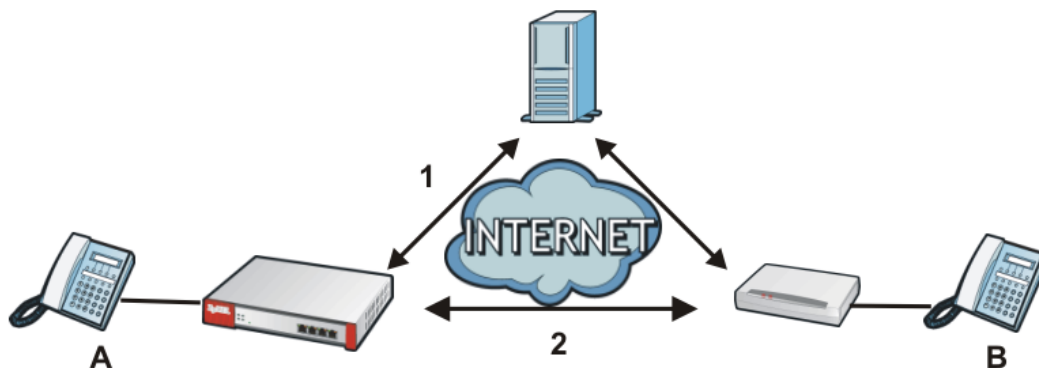

The ALG feature is only needed for traffic that goes through the ZyWALL's NAT.

19.1.1 What You Can Do in this Chapter

Use the **ALG** screen ([Section 19.2 on page 355](#)) to set up SIP, H.323, and FTP ALG settings.

19.1.2 What You Need to Know

Application Layer Gateway (ALG), NAT and Firewall

The ZyWALL can function as an Application Layer Gateway (ALG) to allow certain NAT un-friendly applications (such as SIP) to operate properly through the ZyWALL's NAT and firewall. The ZyWALL dynamically creates an implicit NAT session and firewall session for the application's traffic from the WAN to the LAN. The ALG on the ZyWALL supports all of the ZyWALL's NAT mapping types.

FTP ALG

The FTP ALG allows TCP packets with a specified port destination to pass through. If the FTP server is located on the LAN, you must also configure NAT (port forwarding) and firewall rules if you want to allow access to the server from the WAN.

H.323 ALG

- The H.323 ALG supports peer-to-peer H.323 calls.
- The H.323 ALG handles H.323 calls that go through NAT or that the ZyWALL routes. You can also make other H.323 calls that do not go through NAT or routing. Examples would be calls between LAN IP addresses that are on the same subnet.
- The H.323 ALG allows calls to go out through NAT. For example, you could make a call from a private IP address on the LAN to a peer device on the WAN.
- The H.323 ALG operates on TCP packets with a specified port destination.
- The ZyWALL allows H.323 audio connections.
- The ZyWALL can also apply bandwidth management to traffic that goes through the H.323 ALG.

The following example shows H.323 signaling (1) and audio (2) sessions between H.323 devices A and B.

Figure 212 H.323 ALG Example

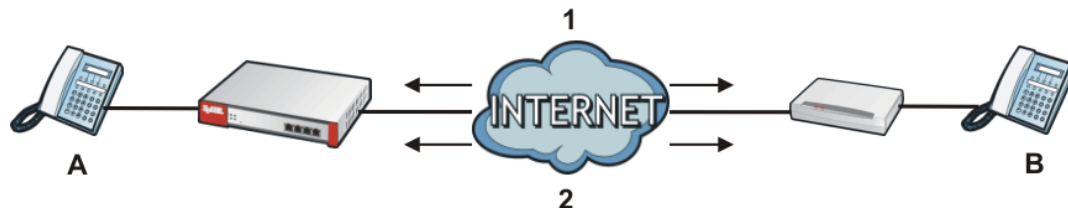

SIP ALG

- SIP phones can be in any zone (including LAN, DMZ, WAN), and the SIP server and SIP clients can be in the same network or different networks.

- There should be only one SIP server (total) on the ZyWALL's private networks. Any other SIP servers must be on the WAN. So for example you could have a Back-to-Back User Agent such as the IPPBX x6004 or an asterisk PBX on the DMZ or on the LAN but not on both.
- Using the SIP ALG allows you to use bandwidth management on SIP traffic.
- The SIP ALG handles SIP calls that go through NAT or that the ZyWALL routes. You can also make other SIP calls that do not go through NAT or routing. Examples would be calls between LAN IP addresses that are on the same subnet.
- The SIP ALG supports peer-to-peer SIP calls. The firewall (by default) allows peer to peer calls from the LAN zone to go to the WAN zone and blocks peer to peer calls from the WAN zone to the LAN zone.
- The SIP ALG allows UDP packets with a specified port destination to pass through.
- The ZyWALL allows SIP audio connections.
- You do not need to use TURN (Traversal Using Relay NAT) for VoIP devices behind the ZyWALL when you enable the SIP ALG.

Peer-to-Peer Calls and the ZyWALL

The ZyWALL ALG can allow peer-to-peer VoIP calls for both H.323 and SIP. You must configure the firewall and NAT (port forwarding) to allow incoming (peer-to-peer) calls from the WAN to a private IP address on the LAN (or DMZ).

VoIP Calls from the WAN with Multiple Outgoing Calls

When you configure the firewall and NAT (port forwarding) to allow calls from the WAN to a specific IP address on the LAN, you can also use policy routing to have H.323 (or SIP) calls from other LAN or DMZ IP addresses go out through a different WAN IP address. The policy routing lets the ZyWALL correctly forward the return traffic for the calls initiated from the LAN IP addresses.

For example, you configure the firewall and NAT to allow LAN IP address **A** to receive calls from the Internet through WAN IP address **1**. You also use a policy route to have LAN IP address **A** make calls out through WAN IP address **1**. Configure another policy route to have H.323 (or SIP) calls from LAN IP addresses **B** and **C** go out through WAN IP address **2**. Even though only LAN IP address **A**

can receive incoming calls from the Internet, LAN IP addresses **B** and **C** can still make calls out to the Internet.

Figure 213 VoIP Calls from the WAN with Multiple Outgoing Calls

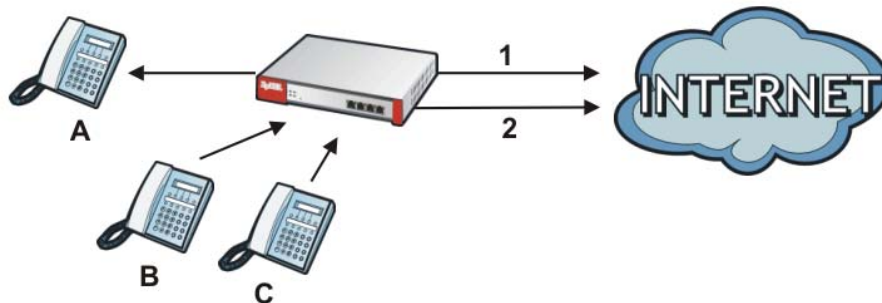

VoIP with Multiple WAN IP Addresses

With multiple WAN IP addresses on the ZyWALL, you can configure different firewall and NAT (port forwarding) rules to allow incoming calls from each WAN IP address to go to a specific IP address on the LAN (or DMZ). Use policy routing to have the H.323 (or SIP) calls from each of those LAN or DMZ IP addresses go out through the same WAN IP address that calls come in on. The policy routing lets the ZyWALL correctly forward the return traffic for the calls initiated from the LAN IP addresses.

For example, you configure firewall and NAT rules to allow LAN IP address **A** to receive calls through public WAN IP address **1**. You configure different firewall and port forwarding rules to allow LAN IP address **B** to receive calls through public WAN IP address **2**. You configure corresponding policy routes to have calls from LAN IP address **A** go out through WAN IP address **1** and calls from LAN IP address **B** go out through WAN IP address **2**.

Figure 214 VoIP with Multiple WAN IP Addresses

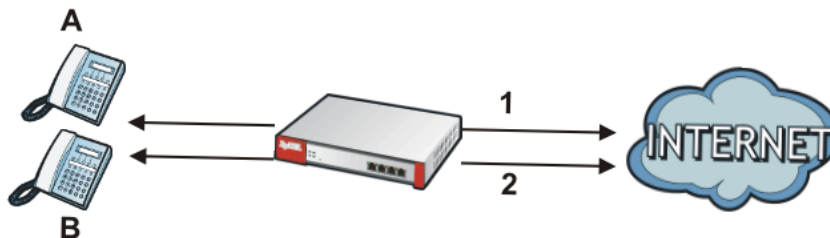

Finding Out More

- See [Section 6.5.11 on page 100](#) for related information on these screens.
- See [Section 7.9 on page 132](#) for a tutorial showing how to use the ALG for peer-to-peer H.323 traffic.
- See [Section 7.11 on page 139](#) for an example of making an IPPBX using SIP or a SIP server in the DMZ zone accessible from the Internet (the WAN zone).

- See [Section 19.3 on page 357](#) for ALG background/technical information.

19.1.3 Before You Begin

You must also configure the firewall and enable NAT in the ZyWALL to allow sessions initiated from the WAN.

19.2 The ALG Screen

Click **Configuration > Network > ALG** to open the **ALG** screen. Use this screen to turn ALGs off or on, configure the port numbers to which they apply, and configure SIP ALG time outs.

Figure 215 Configuration > Network > ALG

The screenshot shows the ALG configuration interface. It is divided into three main sections:

- SIP Settings:**
 - Enable SIP ALG
 - Enable SIP Transformations
 - Enable Configure SIP Inactivity Timeout
 - SIP Media Inactivity Timeout: (seconds)
 - SIP Signaling Inactivity Timeout: (seconds)
 - SIP Signaling Port: (1025-65535)
 - Additional SIP Signaling Port(UDP) for Transformations: (1025-65535) (Optional)
- H.323 Settings:**
 - Enable H.323 ALG
 - Enable H.323 Transformations
 - H.323 Signaling Port: (1025-65535)
 - Additional H.323 Signaling Port for Transformations: (1025-65535) (Optional)
- FTP Settings:**
 - Enable FTP ALG
 - Enable FTP Transformations
 - FTP Signaling Port: (1-65535)
 - Additional FTP Signaling Port for Transformations: (1-65535) (Optional)

At the bottom of the screen are 'Apply' and 'Reset' buttons.

The following table describes the labels in this screen.

Table 98 Configuration > Network > ALG

LABEL	DESCRIPTION
Enable SIP ALG	Turn on the SIP ALG to detect SIP traffic and help build SIP sessions through the ZyWALL's NAT.
Enable SIP Transformations	Select this to have the ZyWALL modify IP addresses and port numbers embedded in the SIP data payload. You do not need to use this if you have a SIP device or server that will modify IP addresses and port numbers embedded in the SIP data payload.

Table 98 Configuration > Network > ALG (continued)

LABEL	DESCRIPTION
Enable Configure SIP Inactivity Timeout	Select this option to have the ZyWALL apply SIP media and signaling inactivity time out limits.
SIP Media Inactivity Timeout	<p>Use this field to set how many seconds (1~86400) the ZyWALL will allow a SIP session to remain idle (without voice traffic) before dropping it.</p> <p>If no voice packets go through the SIP ALG before the timeout period expires, the ZyWALL deletes the audio session. You cannot hear anything and you will need to make a new call to continue your conversation.</p>
SIP Signaling Inactivity Timeout	<p>Most SIP clients have an "expire" mechanism indicating the lifetime of signaling sessions. The SIP user agent sends registration packets to the SIP server periodically and keeps the session alive in the ZyWALL.</p> <p>If the SIP client does not have this mechanism and makes no calls during the ZyWALL SIP timeout, the ZyWALL deletes the signaling session after the timeout period. Enter the SIP signaling session timeout value (1~86400).</p>
SIP Signaling Port	If you are using a custom UDP port number (not 5060) for SIP traffic, enter it here.
Additional SIP Signaling Port(UDP) for Transformations	If you are also using SIP on an additional UDP port number, enter it here.
Enable H.323 ALG	Turn on the H.323 ALG to detect H.323 traffic (used for audio communications) and help build H.323 sessions through the ZyWALL's NAT.
Enable H.323 Transformations	<p>Select this to have the ZyWALL modify IP addresses and port numbers embedded in the H.323 data payload.</p> <p>You do not need to use this if you have a H.323 device or server that will modify IP addresses and port numbers embedded in the H.323 data payload.</p>
H.323 Signaling Port	If you are using a custom TCP port number (not 1720) for H.323 traffic, enter it here.
Additional H.323 Signaling Port for Transformations	If you are also using H.323 on an additional TCP port number, enter it here.
Enable FTP ALG	Turn on the FTP ALG to detect FTP (File Transfer Program) traffic and help build FTP sessions through the ZyWALL's NAT.
Enable FTP Transformations	<p>Select this option to have the ZyWALL modify IP addresses and port numbers embedded in the FTP data payload to match the ZyWALL's NAT environment.</p> <p>Clear this option if you have an FTP device or server that will modify IP addresses and port numbers embedded in the FTP data payload to match the ZyWALL's NAT environment.</p>
FTP Signaling Port	If you are using a custom TCP port number (not 21) for FTP traffic, enter it here.

Table 98 Configuration > Network > ALG (continued)

LABEL	DESCRIPTION
Additional FTP Signaling Port for Transformations	If you are also using FTP on an additional TCP port number, enter it here.
Apply	Click Apply to save your changes back to the ZyWALL.
Reset	Click Reset to return the screen to its last-saved settings.

19.3 ALG Technical Reference

Here is more detailed information about the Application Layer Gateway.

ALG

Some applications cannot operate through NAT (are NAT un-friendly) because they embed IP addresses and port numbers in their packets' data payload. The ZyWALL examines and uses IP address and port number information embedded in the VoIP traffic's data stream. When a device behind the ZyWALL uses an application for which the ZyWALL has VoIP pass through enabled, the ZyWALL translates the device's private IP address inside the data stream to a public IP address. It also records session port numbers and allows the related sessions to go through the firewall so the application's traffic can come in from the WAN to the LAN.

ALG and Trunks

If you send your ALG-managed traffic through an interface trunk and all of the interfaces are set to active, you can configure routing policies to specify which interface the ALG-managed traffic uses.

You could also have a trunk with one interface set to active and a second interface set to passive. The ZyWALL does not automatically change ALG-managed connections to the second (passive) interface when the active interface's connection goes down. When the active interface's connection fails, the client needs to re-initialize the connection through the second interface (that was set to passive) in order to have the connection go through the second interface. VoIP clients usually re-register automatically at set intervals or the users can manually force them to re-register.

FTP

File Transfer Protocol (FTP) is an Internet file transfer service that operates on the Internet and over TCP/IP networks. A system running the FTP server accepts

commands from a system running an FTP client. The service allows users to send commands to the server for uploading and downloading files.

H.323

H.323 is a standard teleconferencing protocol suite that provides audio, data and video conferencing. It allows for real-time point-to-point and multipoint communication between client computers over a packet-based network that does not provide a guaranteed quality of service. NetMeeting uses H.323.

SIP

The Session Initiation Protocol (SIP) is an application-layer control (signaling) protocol that handles the setting up, altering and tearing down of voice and multimedia sessions over the Internet. SIP is used in VoIP (Voice over IP), the sending of voice signals over the Internet Protocol.

SIP signaling is separate from the media for which it handles sessions. The media that is exchanged during the session can use a different path from that of the signaling. SIP handles telephone calls and can interface with traditional circuit-switched telephone networks.

RTP

When you make a VoIP call using H.323 or SIP, the RTP (Real time Transport Protocol) is used to handle voice data transfer. See RFC 1889 for details on RTP.

IP/MAC Binding

20.1 IP/MAC Binding Overview

IP address to MAC address binding helps ensure that only the intended devices get to use privileged IP addresses. The ZyWALL uses DHCP to assign IP addresses and records to MAC address it assigned each IP address. The ZyWALL then checks incoming connection attempts against this list. A user cannot manually assign another IP to his computer and use it to connect to the ZyWALL.

Suppose you configure access privileges for IP address 192.168.1.27 and use static DHCP to assign it to Tim's computer's MAC address of 12:34:56:78:90:AB. IP/MAC binding drops traffic from any computer trying to use IP address 192.168.1.27 with another MAC address.

Figure 216 IP/MAC Binding Example

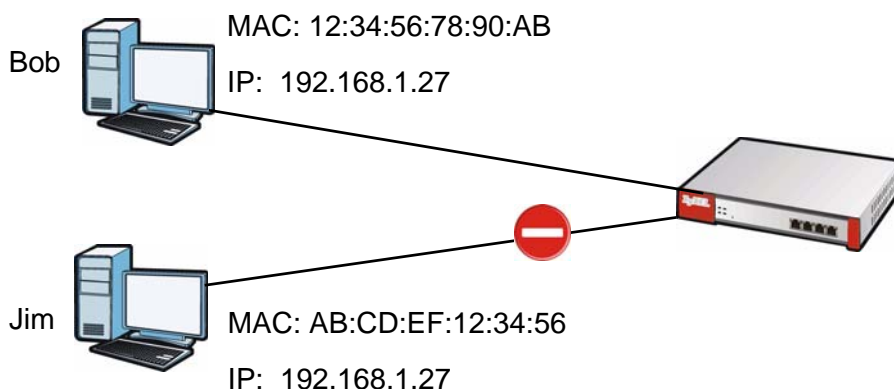

20.1.1 What You Can Do in this Chapter

- Use the **Summary** and **Edit** screens ([Section 20.2 on page 360](#)) to bind IP addresses to MAC addresses.
- Use the **Exempt List** screen ([Section 20.3 on page 363](#)) to configure ranges of IP addresses to which the ZyWALL does not apply IP/MAC binding.

20.1.2 What You Need to Know

DHCP

IP/MAC address bindings are based on the ZyWALL's dynamic and static DHCP entries.

Interfaces Used With IP/MAC Binding

IP/MAC address bindings are grouped by interface. You can use IP/MAC binding with Ethernet, bridge, VLAN, and WLAN (for USG 20W) interfaces. You can also enable or disable IP/MAC binding and logging in an interface's configuration screen.

20.2 IP/MAC Binding Summary

Click **Configuration > Network > IP/MAC Binding** to open the **IP/MAC Binding Summary** screen. This screen lists the total number of IP to MAC address bindings for devices connected to each supported interface.

Figure 217 Configuration > Network > IP/MAC Binding > Summary (USG 20W)

#	Status	Interface	Number of Binding
1		dmz	0
2		lan1	0
3		lan2	1
4		wan1	0

The following table describes the labels in this screen.

Table 99 Configuration > Network > IP/MAC Binding > Summary

LABEL	DESCRIPTION
Edit	Double-click an entry or select it and click Edit to open a screen where you can modify the entry's settings.
Activate	To turn on an entry, select it and click Activate .
Inactivate	To turn off an entry, select it and click Inactivate .
#	This field is a sequential value, and it is not associated with a specific entry.

Table 99 Configuration > Network > IP/MAC Binding > Summary (continued)

LABEL	DESCRIPTION
Status	This icon is lit when the entry is active and dimmed when the entry is inactive.
Interface	This is the name of an interface that supports IP/MAC binding.
Number of Binding	This field displays the interface's total number of IP/MAC bindings and IP addresses that the interface has assigned by DHCP.
Apply	Click Apply to save your changes back to the ZyWALL.

20.2.1 IP/MAC Binding Edit

Click **Configuration > Network > IP/MAC Binding > Edit** to open the **IP/MAC Binding Edit** screen. Use this screen to configure an interface's IP to MAC address binding settings.

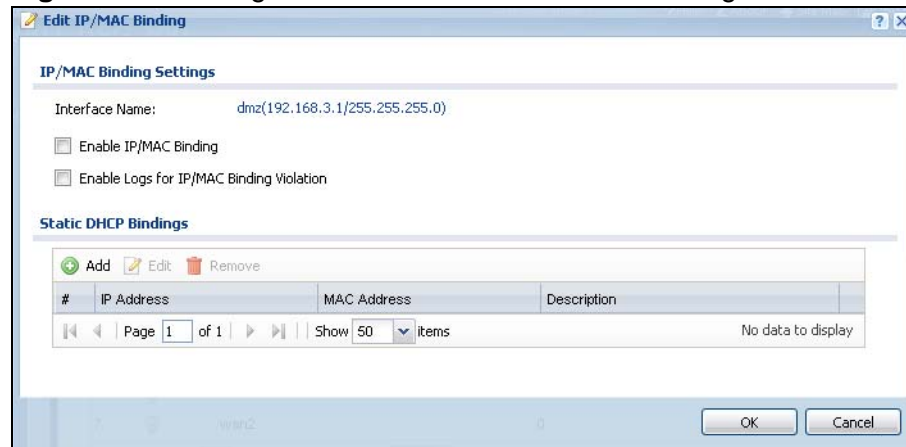
Figure 218 Configuration > Network > IP/MAC Binding > Edit

The following table describes the labels in this screen.

Table 100 Configuration > Network > IP/MAC Binding > Edit

LABEL	DESCRIPTION
IP/MAC Binding Settings	
Interface Name	This field displays the name of the interface within the ZyWALL and the interface's IP address and subnet mask.
Enable IP/MAC Binding	Select this option to have this interface enforce links between specific IP addresses and specific MAC addresses. This stops anyone else from manually using a bound IP address on another device connected to this interface. Use this to make use only the intended users get to use specific IP addresses.
Enable Logs for IP/MAC Binding Violation	Select this option to have the ZyWALL generate a log if a device connected to this interface attempts to use an IP address not assigned by the ZyWALL.

Table 100 Configuration > Network > IP/MAC Binding > Edit (continued)

LABEL	DESCRIPTION
Static DHCP Bindings	This table lists the bound IP and MAC addresses. The ZyWALL checks this table when it assigns IP addresses. If the computer's MAC address is in the table, the ZyWALL assigns the corresponding IP address. You can also access this table from the interface's edit screen.
Add	Click this to create a new entry.
Edit	Double-click an entry or select it and click Edit to open a screen where you can modify the entry's settings.
Remove	To remove an entry, select it and click Remove . The ZyWALL confirms you want to remove it before doing so.
#	This is the index number of the static DHCP entry.
IP Address	This is the IP address that the ZyWALL assigns to a device with the entry's MAC address.
MAC Address	This is the MAC address of the device to which the ZyWALL assigns the entry's IP address.
Description	This helps identify the entry.
OK	Click OK to save your changes back to the ZyWALL.
Cancel	Click Cancel to exit this screen without saving.

20.2.2 Static DHCP Edit

Click **Configuration > Network > IP/MAC Binding > Edit** to open the **IP/MAC Binding Edit** screen. Click the **Add** or **Edit** icon to open the following screen. Use this screen to configure an interface's IP to MAC address binding settings.

Figure 219 Configuration > Network > IP/MAC Binding > Edit > Add

The following table describes the labels in this screen.

Table 101 Configuration > Network > IP/MAC Binding > Edit > Add

LABEL	DESCRIPTION
Interface Name	This field displays the name of the interface within the ZyWALL and the interface's IP address and subnet mask.
IP Address	Enter the IP address that the ZyWALL is to assign to a device with the entry's MAC address.

Table 101 Configuration > Network > IP/MAC Binding > Edit > Add (continued)

LABEL	DESCRIPTION
MAC Address	Enter the MAC address of the device to which the ZyWALL assigns the entry's IP address.
Description	Enter up to 64 printable ASCII characters to help identify the entry. For example, you may want to list the computer's owner.
OK	Click OK to save your changes back to the ZyWALL.
Cancel	Click Cancel to exit this screen without saving.

20.3 IP/MAC Binding Exempt List

Click **Configuration > Network > IP/MAC Binding > Exempt List** to open the **IP/MAC Binding Exempt List** screen. Use this screen to configure ranges of IP addresses to which the ZyWALL does not apply IP/MAC binding.

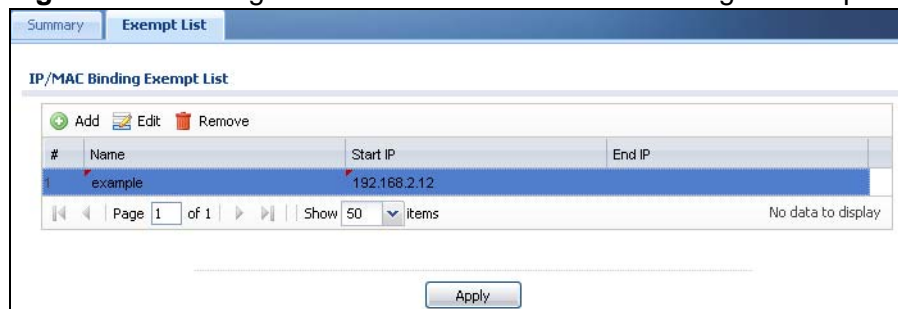
Figure 220 Configuration > Network > IP/MAC Binding > Exempt List

The following table describes the labels in this screen.

Table 102 Configuration > Network > IP/MAC Binding > Exempt List

LABEL	DESCRIPTION
Add	Click this to create a new entry.
Edit	Click an entry or select it and click Edit to modify the entry's settings.
Remove	To remove an entry, select it and click Remove . The ZyWALL confirms you want to remove it before doing so.
#	This is the index number of the IP/MAC binding list entry.
Name	Enter a name to help identify this entry.
Start IP	Enter the first IP address in a range of IP addresses for which the ZyWALL does not apply IP/MAC binding.
End IP	Enter the last IP address in a range of IP addresses for which the ZyWALL does not apply IP/MAC binding.
Add icon	Click the Add icon to add a new entry. Click the Remove icon to delete an entry. A window displays asking you to confirm that you want to delete it.
Apply	Click Apply to save your changes back to the ZyWALL.

Authentication Policy

21.1 Overview

Use authentication policies to control who can access the network. You can authenticate users (require them to log in) and even perform Endpoint Security (EPS) checking to make sure users' computers comply with defined corporate policies before they can access the network. After a user passes authentication the user's computer must meet the endpoint security object's Operating System (OS) option and security requirements to gain access. See [Chapter 42 on page 621](#) for how to configure endpoint security objects to use with authentication policies.

In the following figure the ZyWALL's authentication policy requires endpoint security checking on local user **A**. **A** passes authentication and the endpoint security check and is given access. Local user **B** passes authentication but fails the endpoint security check and is denied access.

Figure 221 Authentication Policy Using Endpoint Security

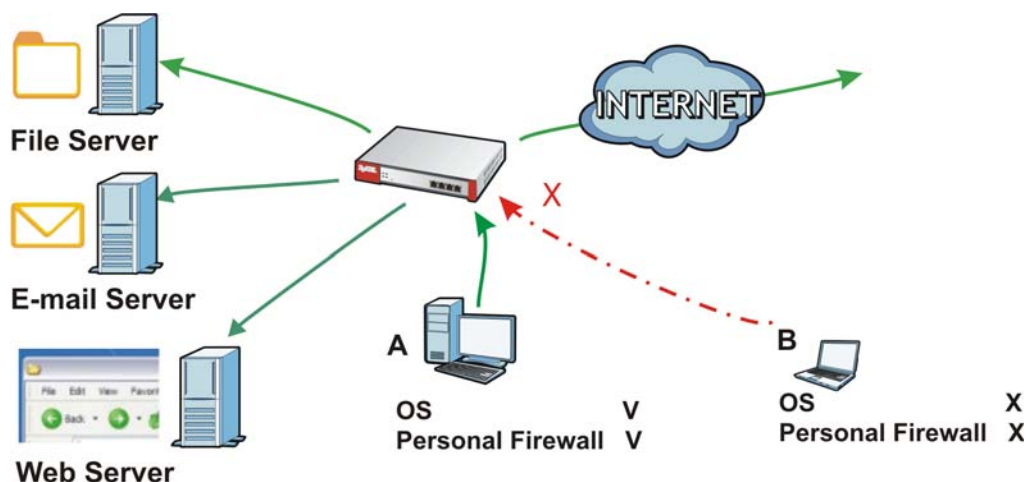

21.1.1 What You Can Do in this Chapter

Use the **Configuration > Auth. Policy** screens ([Section 21.2 on page 366](#)) to create and manage authentication policies.

21.1.2 What You Need to Know

Authentication Policy and VPN

Authentication policies are applied based on a traffic flow's source and destination IP addresses. If VPN traffic matches an authentication policy's source and destination IP addresses, the user must pass authentication.

Multiple Endpoint Security Objects

You can set an authentication policy to use multiple endpoint security objects. This allows checking of computers with different OSs or security settings. When a client attempts to log in, the ZyWALL checks the client's computer against the endpoint security objects one-by-one. The client's computer must match one of the authentication policy's endpoint security objects in order to gain access.

Forced User Authentication

Instead of making users for which user-aware policies have been configured go to the ZyWALL **Login** screen manually, you can configure the ZyWALL to display the **Login** screen automatically whenever it routes HTTP traffic for anyone who has not logged in yet.

Note: This works with HTTP traffic only. The ZyWALL does display the **Login** screen when users attempt to send other kinds of traffic.

The ZyWALL does not automatically route the request that prompted the login, however, so users have to make this request again.

Finding Out More

See [Section 7.7 on page 126](#) for an example of how to use endpoint security and authentication policies.

21.2 Authentication Policy Screen

The **Authentication Policy** screen displays the authentication policies you have configured on the ZyWALL.

Click **Configuration > Auth. Policy** to display the screen.

Figure 222 Configuration > Auth. Policy

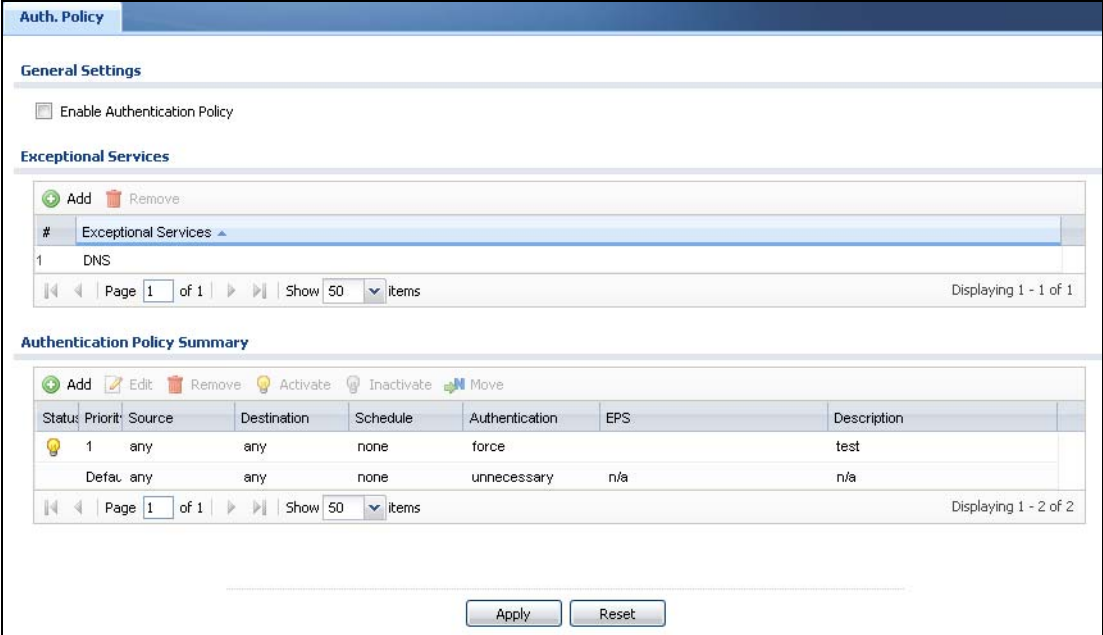

The following table gives an overview of the objects you can configure.

Table 103 Configuration > Auth. Policy

LABEL	DESCRIPTION
Enable Authentication Policy	Select this to turn on the authentication policy feature.
Exceptional Services	<p>Use this table to list services that users can access without logging in.</p> <p>Click Add to change the list's membership. A screen appears. Available services appear on the left. Select any services you want users to be able to access without logging in and click the right arrow button to add them. The member services are the right. Select any service that you want to remove from the member list, and click the left arrow button to remove them.</p> <p>Keeping DNS as a member allows users' computers to resolve domain names into IP addresses.</p> <p>Figure 223 Configuration > Auth. Policy > Add Exceptional Service</p>  <p>In the table, select one or more entries and click Remove to delete it or them.</p>
Authentication Policy Summary	Use this table to manage the ZyWALL's list of authentication policies.
Add	Click this to create a new entry. Select an entry and click Add to create a new entry after the selected entry.
Edit	Double-click an entry or select it and click Edit to open a screen where you can modify the entry's settings.
Remove	To remove an entry, select it and click Remove . The ZyWALL confirms you want to remove it before doing so.
Activate	To turn on an entry, select it and click Activate .
Inactivate	To turn off an entry, select it and click Inactivate .
Move	To move an entry to a different number in the list, click the Move icon. In the field that appears, specify the number to which you want to move the interface.

Table 103 Configuration > Auth. Policy (continued)

LABEL	DESCRIPTION
Status	This icon is lit when the entry is active and dimmed when the entry is inactive.
Priority	This is the position of the authentication policy in the list. The priority is important as the policies are applied in order of priority. Default displays for the default authentication policy that the ZyWALL uses on traffic that does not match any exceptional service or other authentication policy. You can edit the default rule but not delete it.
Source	This displays the source address object to which this policy applies.
Destination	This displays the destination address object to which this policy applies.
Schedule	This field displays the schedule object that dictates when the policy applies. none means the policy is active at all times if enabled.
Authentication	This field displays the authentication requirement for users when their traffic matches this policy. This is n/a for the default policy. unnecessary - Users do not need to be authenticated. required - Users need to be authenticated. They must manually go to the login screen. The ZyWALL will not redirect them to the login screen. force - Users need to be authenticated. The ZyWALL automatically displays the login screen whenever it routes HTTP traffic for users who have not logged in yet.
EPS	This lists any endpoint security objects the policy uses.
Description	If the entry has a description configured, it displays here.
Apply	Click this button to save your changes to the ZyWALL.
Reset	Click this button to return the screen to its last-saved settings.

21.2.1 Creating/Editing an Authentication Policy

Click **Configuration > Auth. Policy** and then the **Add** (or **Edit**) icon to open the **Endpoint Security Edit** screen. Use this screen to configure an authentication policy.

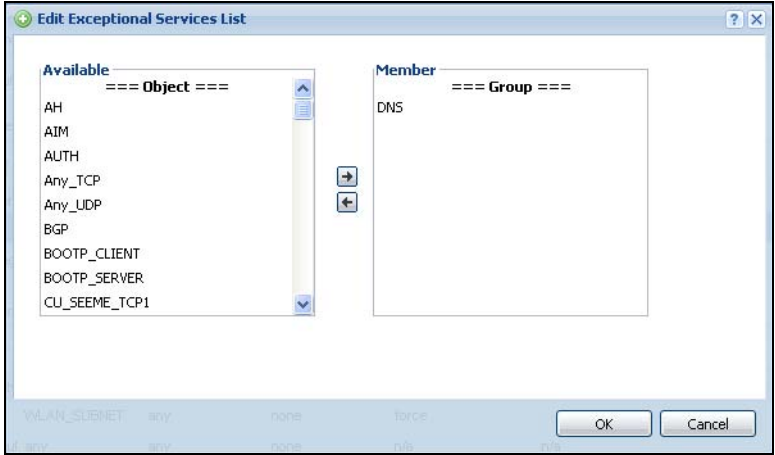
Figure 224 Configuration > Auth. Policy > Add

The following table gives an overview of the objects you can configure.

Table 104 Configuration > Auth. Policy > Add

LABEL	DESCRIPTION
Create new Object	Use to configure any new settings objects that you need to use in this screen.
Enable Policy	Select this check box to activate the authentication policy. This field is available for user-configured policies.
Description	Enter a descriptive name of up to 60 printable ASCII characters for the policy. Spaces are allowed. This field is available for user-configured policies.
User Authentication Policy	Use this section of the screen to determine which traffic requires (or does not require) the senders to be authenticated in order to be routed.
Source Address	Select a source address or address group for whom this policy applies. Select any if the policy is effective for every source. This is any and not configurable for the default policy.
Destination Address	Select a destination address or address group for whom this policy applies. Select any if the policy is effective for every destination. This is any and not configurable for the default policy.

Table 104 Configuration > Auth. Policy > Add (continued)

LABEL	DESCRIPTION
Schedule	Select a schedule that defines when the policy applies. Otherwise, select none and the rule is always effective. This is none and not configurable for the default policy.
Authentication	Select the authentication requirement for users when their traffic matches this policy. unnecessary - Users do not need to be authenticated. required - Users need to be authenticated. They must manually go to the login screen. The ZyWALL will not redirect them to the login screen.
Log	This field is available for the default policy. Select whether to have the ZyWALL generate a log (log), log and alert (log alert) or not (no) for packets that match the default policy. See Chapter 44 on page 679 for more on logs.
Force User Authentication	This field is available for user-configured policies that require authentication. Select this to have the ZyWALL automatically display the login screen when users who have not logged in yet try to send HTTP traffic.
Endpoint Security (EPS)	These fields display when you set the Authentication field to required . Use these fields to make sure users' computers meet an endpoint security object's Operating System (OS) and security requirements before granting access. These fields are available for user-configured policies that require authentication.
Enable EPS Checking	Select this to have the ZyWALL check that users' computers meet the Operating System (OS) and security requirements of one of the policy's selected endpoint security objects before granting access.
Periodical checking time	Select this and specify a number of minutes to have the ZyWALL repeat the endpoint security check at a regular interval.
Available EPS Object / Selected EPS Object	Configured endpoint security objects appear on the left. Select the endpoint security objects to use for this policy and click the right arrow button to add them to the selected list on the right. Use the [Shift] and/or [Ctrl] key to select multiple objects. Select any endpoint security objects that you want to remove from the selected list and click the left arrow button to remove them. The ZyWALL checks authenticated users' computers against the policy's selected endpoint security objects in the order you list them here. When a user's computer matches an endpoint security object the ZyWALL grants access and stops checking. Select an endpoint security object and use the up and down arrows to change its position in the list. To make the endpoint security check as efficient as possible, arrange the endpoint security objects in order with the one that the most users should match first and the one that the least user's should match last.
OK	Click OK to save your changes back to the ZyWALL.
Cancel	Click Cancel to exit this screen without saving.

22.1 Overview

Use the firewall to block or allow services that use static port numbers. The firewall can also limit the number of user sessions.

This figure shows the ZyWALL's default firewall rules in action and demonstrates how stateful inspection works. User 1 can initiate a Telnet session from within the LAN1 zone and responses to this request are allowed. However, other Telnet traffic initiated from the WAN or DMZ zone and destined for the LAN1 zone is blocked. Communications between the WAN and the DMZ zones are allowed. The firewall allows VPN traffic between any of the networks.

Figure 225 Default Firewall Action

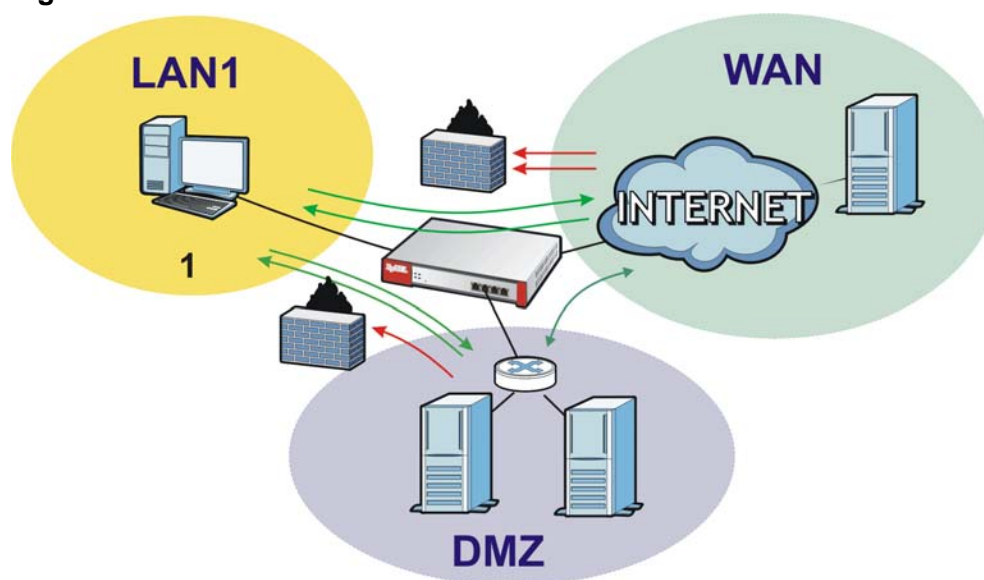

22.1.1 What You Can Do in this Chapter

- Use the **Firewall** screens ([Section 22.2 on page 381](#)) to enable or disable the firewall and asymmetrical routes, and manage and configure firewall rules.
- Use the **Session Limit** screens (see [Section 22.3 on page 386](#)) to limit the number of concurrent NAT/firewall sessions a client can use.

22.1.2 What You Need to Know

Stateful Inspection

The ZyWALL has a stateful inspection firewall. The ZyWALL restricts access by screening data packets against defined access rules. It also inspects sessions. For example, traffic from one zone is not allowed unless it is initiated by a computer in another zone first.

Zones

A zone is a group of interfaces or VPN tunnels. Group the ZyWALL's interfaces into different zones based on your needs. You can configure firewall rules for data passing between zones or even between interfaces and/or VPN tunnels in a zone.

Default Firewall Behavior

Firewall rules are grouped based on the direction of travel of packets to which they apply. Here is the default firewall behavior for traffic going through the ZyWALL in various directions.

Table 105 Default Firewall Behavior

FROM ZONE TO ZONE	BEHAVIOR
From WAN to ZyWALL	Traffic from the WAN to the ZyWALL itself is allowed for certain default services described in To-ZyWALL Rules on page 375 . All other WAN to ZyWALL traffic is dropped.
From WAN to any (other than the ZyWALL)	Traffic from the WAN to any of the networks behind the ZyWALL is dropped.
From DMZ to ZyWALL	Traffic from the DMZ to the ZyWALL itself is allowed for certain default services described in To-ZyWALL Rules on page 375 . All other DMZ to ZyWALL traffic is dropped.
From DMZ to any (other than the ZyWALL)	Traffic from the DMZ to any of the networks behind the ZyWALL is dropped.
From WLAN to WAN (USG 20W)	Traffic from the WLAN to the WAN is allowed.
From WLAN to ZyWALL (USG 20W)	Traffic from the WLAN to the ZyWALL itself is allowed for certain default services described in To-ZyWALL Rules on page 375 . All other WLAN to ZyWALL traffic is dropped.
From WLAN to any (other than the ZyWALL) (USG 20W)	Traffic from the WLAN to any of the networks behind the ZyWALL is dropped.
From ANY to ANY	Traffic that does not match any firewall rule is allowed. So for example, LAN to WAN, LAN to DMZ, and LAN to WLAN traffic is allowed. This also includes traffic to or from interfaces or VPN tunnels that are not assigned to a zone (extra-zone traffic).

To-ZyWALL Rules

Rules with **ZyWALL** as the **To Zone** apply to traffic going to the ZyWALL itself. By default:

- The firewall allows only LAN, WLAN (USG 20W), or WAN computers to access or manage the ZyWALL.
- The ZyWALL drops most packets from the WAN zone to the ZyWALL itself, except for ESP/AH/IKE/NATT/HTTPS services for VPN tunnels, and generates a log.
- The ZyWALL drops most packets from the DMZ zone to the ZyWALL itself, except for DNS and NetBIOS traffic, and generates a log.

When you configure a firewall rule for packets destined for the ZyWALL itself, make sure it does not conflict with your service control rule. See [Chapter 43 on page 629](#) for more information about service control (remote management). The ZyWALL checks the firewall rules before the service control rules for traffic destined for the ZyWALL.

You can configure a To-ZyWALL firewall rule (with **From Any To ZyWALL** direction) for traffic from an interface which is not in a zone.

Global Firewall Rules

Firewall rules with **from any** and/or **to any** as the packet direction are called global firewall rules. The global firewall rules are the only firewall rules that apply to an interface or VPN tunnel that is not included in a zone. The **from any** rules apply to traffic coming from the interface and the **to any** rules apply to traffic going to the interface.

Firewall Rule Criteria

The ZyWALL checks the schedule, user name (user's login name on the ZyWALL), source IP address, destination IP address and IP protocol type of network traffic against the firewall rules (in the order you list them). When the traffic matches a rule, the ZyWALL takes the action specified in the rule.

User Specific Firewall Rules

You can specify users or user groups in firewall rules. For example, to allow a specific user from any computer to access a zone by logging in to the ZyWALL, you can set up a rule based on the user name only. If you also apply a schedule to the firewall rule, the user can only access the network at the scheduled time. A user-aware firewall rule is activated whenever the user logs in to the ZyWALL and will be disabled after the user logs out of the ZyWALL.

Firewall and VPN Traffic

After you create a VPN tunnel and add it to a zone, you can set the firewall rules applied to VPN traffic. If you add a VPN tunnel to an existing zone (the LAN1 zone for example), you can configure a new LAN1 to LAN1 firewall rule or use intra-zone traffic blocking to allow or block VPN traffic transmitting between the VPN tunnel and other interfaces in the LAN zone. If you add the VPN tunnel to a new zone (the VPN zone for example), you can configure rules for VPN traffic between the VPN zone and other zones or **From VPN To-ZyWALL** rules for VPN traffic destined for the ZyWALL.

Session Limits

Accessing the ZyWALL or network resources through the ZyWALL requires a NAT session and corresponding firewall session. Peer to peer applications, such as file sharing applications, may use a large number of NAT sessions. A single client could use all of the available NAT sessions and prevent others from connecting to or through the ZyWALL. The ZyWALL lets you limit the number of concurrent NAT/firewall sessions a client can use.

Finding Out More

- See [Section 6.5.13 on page 100](#) for related information on the **Firewall** screens.
- See [Section 7.8 on page 129](#) for an example of creating firewall rules as part of configuring user-aware access control ([Section 7.5 on page 120](#)).
- See [Section 7.9.3 on page 135](#) for an example of creating a firewall rule to allow H.323 traffic from the WAN to the LAN.
- See [Section 7.10.3 on page 138](#) for an example of creating a firewall rule to allow web traffic from the WAN to a server on the DMZ.
- See [Section 7.11.4 on page 143](#) for an example of creating firewall rules to allow SIP traffic for an IPPBX or SIP server on the DMZ.

22.1.3 Firewall Rule Example Applications

Suppose that your company decides to block all of the LAN users from using IRC (Internet Relay Chat) through the Internet. To do this, you would configure a LAN to WAN firewall rule that blocks IRC traffic from any source IP address from going to any destination address. You do not need to specify a schedule since you need

the firewall rule to always be in effect. The following figure shows the results of this rule.

Figure 226 Blocking All LAN to WAN IRC Traffic Example

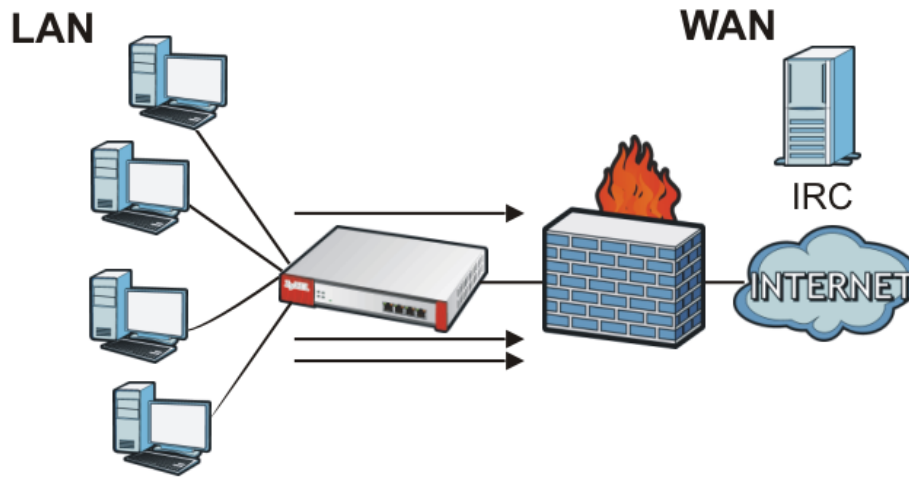

Your firewall would have the following rules.

Table 106 Blocking All LAN to WAN IRC Traffic Example

#	USER	SOURCE	DESTINATION	SCHEDULE	SERVICE	ACTION
1	Any	Any	Any	Any	IRC	Deny
2	Any	Any	Any	Any	Any	Allow

- The first row blocks LAN access to the IRC service on the WAN.
- The second row is the firewall's default policy that allows all LAN1 to WAN traffic.

The ZyWALL applies the firewall rules in order. So for this example, when the ZyWALL receives traffic from the LAN, it checks it against the first rule. If the traffic matches (if it is IRC traffic) the firewall takes the action in the rule (drop) and stops checking the firewall rules. Any traffic that does not match the first firewall rule will match the second rule and the ZyWALL forwards it.

Now suppose that your company wants to let the CEO use IRC. You can configure a LAN1 to WAN firewall rule that allows IRC traffic from the IP address of the CEO's computer. You can also configure a LAN to WAN rule that allows IRC traffic from any computer through which the CEO logs into the ZyWALL with his/her user name. In order to make sure that the CEO's computer always uses the same IP address, make sure it either:

- Has a static IP address,
or
- You configure a static DHCP entry for it so the ZyWALL always assigns it the same IP address (see [DHCP Settings on page 286](#) for information on DHCP).

Now you configure a LAN1 to WAN firewall rule that allows IRC traffic from the IP address of the CEO's computer (192.168.1.7 for example) to go to any destination address. You do not need to specify a schedule since you want the firewall rule to always be in effect. The following figure shows the results of your two custom rules.

Figure 227 Limited LAN to WAN IRC Traffic Example

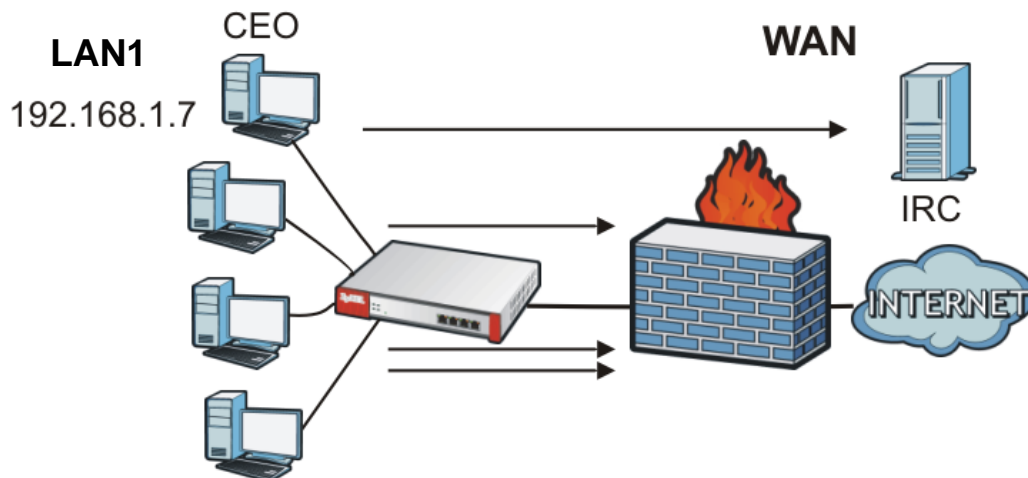

Your firewall would have the following configuration.

Table 107 Limited LAN1 to WAN IRC Traffic Example 1

#	USER	SOURCE	DESTINATION	SCHEDULE	SERVICE	ACTION
1	Any	192.168.1.7	Any	Any	IRC	Allow
2	Any	Any	Any	Any	IRC	Deny
3	Any	Any	Any	Any	Any	Allow

- The first row allows the LAN1 computer at IP address 192.168.1.7 to access the IRC service on the WAN.
- The second row blocks LAN1 access to the IRC service on the WAN.
- The third row is the firewall's default policy of allowing all traffic from the LAN1 to go to the WAN.

Alternatively, you configure a LAN1 to WAN rule with the CEO's user name (say CEO) to allow IRC traffic from any source IP address to go to any destination address.

Your firewall would have the following configuration.

Table 108 Limited LAN1 to WAN IRC Traffic Example 2

#	USER	SOURCE	DESTINATION	SCHEDULE	SERVICE	ACTION
1	CEO	Any	Any	Any	IRC	Allow
2	Any	Any	Any	Any	IRC	Deny
3	Any	Any	Any	Any	Any	Allow

- The first row allows any LAN1 computer to access the IRC service on the WAN by logging into the ZyWALL with the CEO's user name.
- The second row blocks LAN1 access to the IRC service on the WAN.
- The third row is the firewall's default policy of allowing all traffic from the LAN1 to go to the WAN.

The rule for the CEO must come before the rule that blocks all LAN1 to WAN IRC traffic. If the rule that blocks all LAN1 to WAN IRC traffic came first, the CEO's IRC traffic would match that rule and the ZyWALL would drop it and not check any other firewall rules.

22.1.4 Firewall Rule Configuration Example

The following Internet firewall rule example allows Doom players from the WAN to IP addresses 192.168.1.10 through 192.168.1.15 (Dest_1) on the LAN1.

- 1 Click **Configuration > Firewall**. In the summary of firewall rules click **Add** in the heading row to configure a new first entry. Remember the sequence (priority) of the rules is important since they are applied in order.

Figure 228 Firewall Example: Firewall Screen

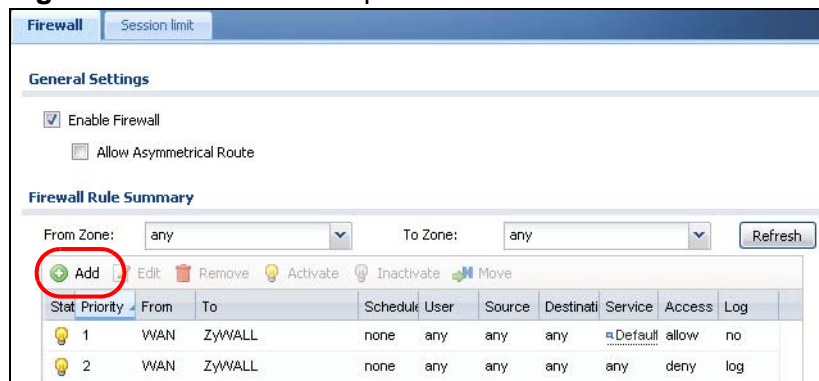

- 2 At the top of the screen, click **Create new Object > Address**.
- 3 The screen for configuring an address object opens. Configure it as follows and click **OK**.

Figure 229 Firewall Example: Create an Address Object

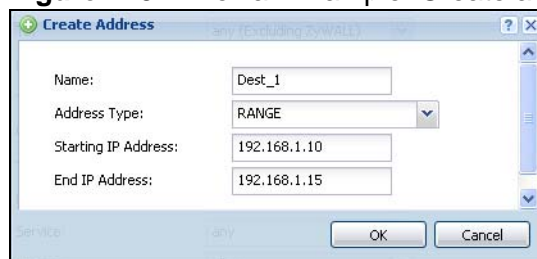

- 4 Click **Create new Object > Service**.

- 5 The screen for configuring a service object opens. Configure it as follows and click **OK**.

Figure 230 Firewall Example: Create a Service Object

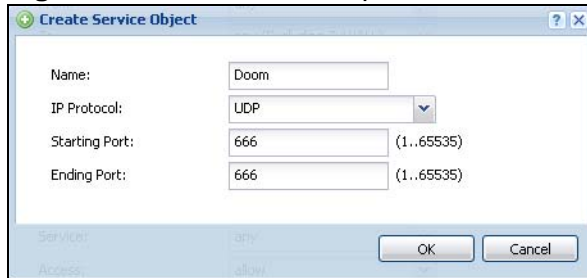

The screenshot shows the 'Create Service Object' dialog box. It has the following fields and values:

Name:	Doom
IP Protocol:	UDP
Starting Port:	666 (1..65535)
Ending Port:	666 (1..65535)

At the bottom, there are 'OK' and 'Cancel' buttons.

- 6 Select **From WAN** and **To LAN1**.
- 7 Enter the name of the firewall rule.
- 8 Select **Dest_1** is selected for the **Destination** and **Doom** is selected as the **Service**. Enter a description and configure the rest of the screen as follows. Click **OK** when you are done.

Figure 231 Firewall Example: Edit a Firewall Rule

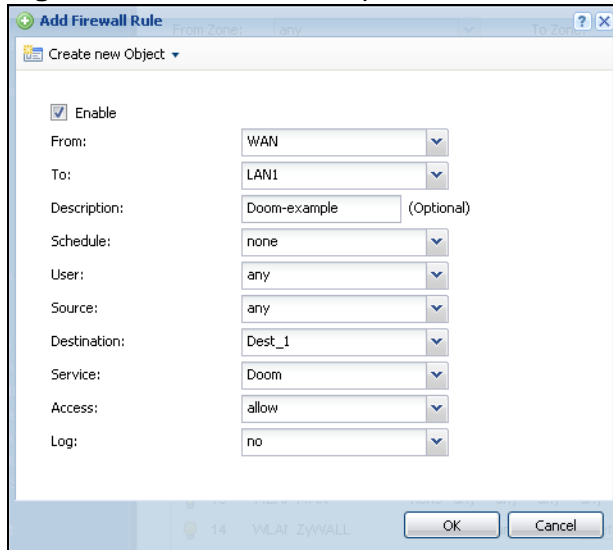

The screenshot shows the 'Add Firewall Rule' dialog box. It has the following fields and values:

<input checked="" type="checkbox"/> Enable	
From:	WAN
To:	LAN1
Description:	Doom-example (Optional)
Schedule:	none
User:	any
Source:	any
Destination:	Dest_1
Service:	Doom
Access:	allow
Log:	no

At the bottom, there are 'OK' and 'Cancel' buttons.

- 9 The firewall rule appears in the firewall rule summary.

Figure 232 Firewall Example: Doom Rule in Summary

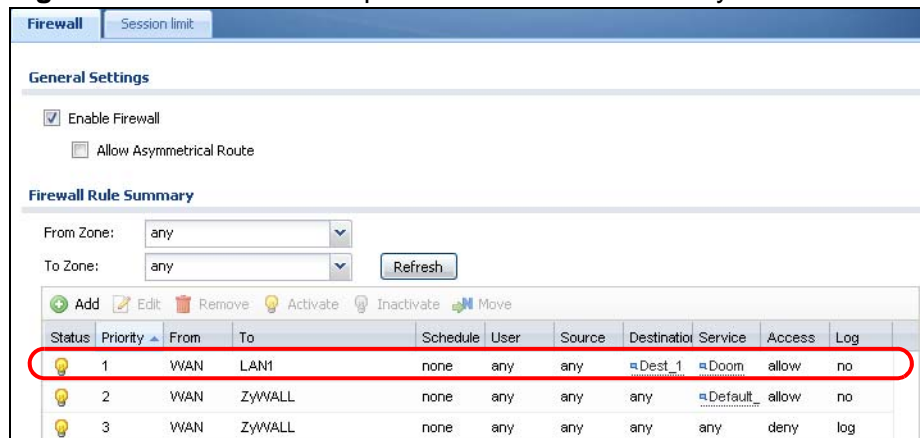

22.2 The Firewall Screen

Asymmetrical Routes

If an alternate gateway on the LAN has an IP address in the same subnet as the ZyWALL's LAN IP address, return traffic may not go through the ZyWALL. This is called an asymmetrical or "triangle" route. This causes the ZyWALL to reset the connection, as the connection has not been acknowledged.

You can have the ZyWALL permit the use of asymmetrical route topology on the network (not reset the connection). However, allowing asymmetrical routes may let traffic from the WAN go directly to the LAN without passing through the ZyWALL. A better solution is to use virtual interfaces to put the ZyWALL and the backup gateway on separate subnets. Virtual interfaces allow you to partition your network into logical sections over the same interface. See the chapter about interfaces for more information.

By putting LAN 1 and the alternate gateway (**A** in the figure) in different subnets, all returning network traffic must pass through the ZyWALL to the LAN. The following steps and figure describe such a scenario.

- 1 A computer on the LAN1 initiates a connection by sending a SYN packet to a receiving server on the WAN.
- 2 The ZyWALL reroutes the packet to gateway **A**, which is in **Subnet 2**.
- 3 The reply from the WAN goes to the ZyWALL.

- 4 The ZyWALL then sends it to the computer on the LAN1 in **Subnet 1**.

Figure 233 Using Virtual Interfaces to Avoid Asymmetrical Routes

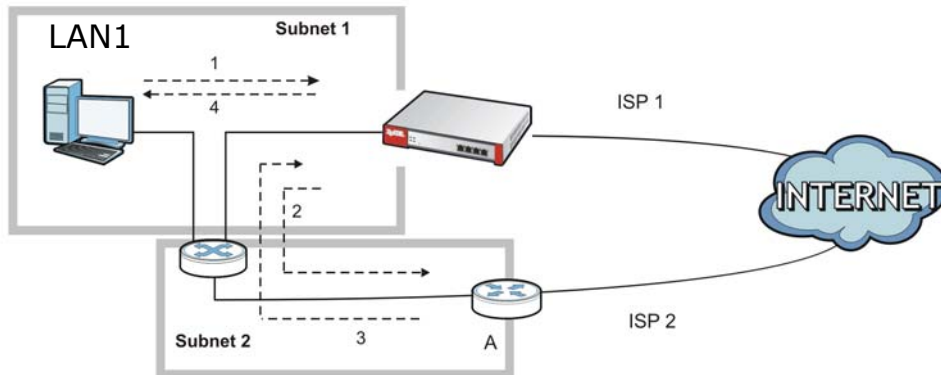

22.2.1 Configuring the Firewall Screen

Click **Configuration > Firewall** to open the **Firewall** screen. Use this screen to enable or disable the firewall and asymmetrical routes, set a maximum number of sessions per host, and display the configured firewall rules. Specify from which zone packets come and to which zone packets travel to display only the rules specific to the selected direction. Note the following.

- If you enable intra-zone traffic blocking (see the chapter about zones), the firewall automatically creates (implicit) rules to deny packet passage between the interfaces in the specified zone.
- Besides configuring the firewall, you also need to configure NAT rules to allow computers on the WAN to access LAN devices. See [Chapter 17 on page 337](#) for more information.
- The ZyWALL applies NAT (Destination NAT) settings before applying the firewall rules. So for example, if you configure a NAT entry that sends WAN traffic to a LAN IP address, when you configure a corresponding firewall rule to allow the traffic, you need to set the LAN IP address as the destination. See [Section 7.9 on page 132](#) for an example.

- The ordering of your rules is very important as rules are applied in sequence.

Figure 234 Configuration > Firewall (USG 20W)

The screenshot shows the Firewall configuration page. Under 'General Settings', there are two unchecked checkboxes: 'Enable Firewall' and 'Allow Asymmetrical Route'. The 'Firewall Rule Summary' section has 'From Zone' and 'To Zone' both set to 'any'. Below this is a table of firewall rules:

Stat	Priority	From	To	Schedule	User	Source	Destination	Service	Access	Log
1		any	ZyWALL	none	any	any	any	Default	allow	no
2		any	ZyWALL	none	any	any	any	any	deny	log
3		any	any (Excl	none	any	any	any	any	deny	log
4		any	ZyWALL	none	any	any	any	Default	allow	no
5		any	ZyWALL	none	any	any	any	any	deny	log
6		any	any	none	any	any	any	any	allow	no
7		any	any (Excl	none	any	any	any	any	deny	log
8		any	any	none	any	any	any	any	allow	no
9		any	ZyWALL	none	any	any	any	Default	allow	no
10		any	ZyWALL	none	any	any	any	any	deny	log
11		any	any (Excl	none	any	any	any	any	deny	log
Default		any	any	none	any	any	any	any	allow	no

At the bottom of the table, it says 'Page 1 of 1' and 'Showing 50 items'. There are 'Apply' and 'Reset' buttons at the bottom of the screen.

The following table describes the labels in this screen.

Table 109 Configuration > Firewall

LABEL	DESCRIPTION
General Settings	
Enable Firewall	Select this check box to activate the firewall. The ZyWALL performs access control when the firewall is activated.
Allow Asymmetrical Route	<p>If an alternate gateway on the LAN has an IP address in the same subnet as the ZyWALL's LAN IP address, return traffic may not go through the ZyWALL. This is called an asymmetrical or "triangle" route. This causes the ZyWALL to reset the connection, as the connection has not been acknowledged.</p> <p>Select this check box to have the ZyWALL permit the use of asymmetrical route topology on the network (not reset the connection).</p> <p>Note: Allowing asymmetrical routes may let traffic from the WAN go directly to the LAN without passing through the ZyWALL. A better solution is to use virtual interfaces to put the ZyWALL and the backup gateway on separate subnets.</p>
Firewall Rule Summary	

Table 109 Configuration > Firewall (continued)

LABEL	DESCRIPTION
From Zone / To Zone	<p>This is the direction of travel of packets. Select from which zone the packets come and to which zone they go.</p> <p>Firewall rules are grouped based on the direction of travel of packets to which they apply. For example, from LAN1 to LAN1 means packets traveling from a computer or subnet on the LAN to either another computer or subnet on the LAN1.</p> <p>From any displays all the firewall rules for traffic going to the selected To Zone.</p> <p>To any displays all the firewall rules for traffic coming from the selected From Zone.</p> <p>From any to any displays all of the firewall rules.</p> <p>To ZyWALL rules are for traffic that is destined for the ZyWALL and control which computers can manage the ZyWALL.</p>
Add	Click this to create a new entry. Select an entry and click Add to create a new entry after the selected entry.
Edit	Double-click an entry or select it and click Edit to open a screen where you can modify the entry's settings.
Remove	To remove an entry, select it and click Remove . The ZyWALL confirms you want to remove it before doing so.
Activate	To turn on an entry, select it and click Activate .
Inactivate	To turn off an entry, select it and click Inactivate .
Move	<p>To change a rule's position in the numbered list, select the rule and click Move to display a field to type a number for where you want to put that rule and press [ENTER] to move the rule to the number that you typed.</p> <p>The ordering of your rules is important as they are applied in order of their numbering.</p>
The following read-only fields summarize the rules you have created that apply to traffic traveling in the selected packet direction.	
Status	This icon is lit when the entry is active and dimmed when the entry is inactive.
Priority	This is the position of your firewall rule in the global rule list (including all through-ZyWALL and to-ZyWALL rules). The ordering of your rules is important as rules are applied in sequence. Default displays for the default firewall behavior that the ZyWALL performs on traffic that does not match any other firewall rule.
From To	This is the direction of travel of packets to which the firewall rule applies.
Schedule	This field tells you the schedule object that the rule uses. none means the rule is active at all times if enabled.
User	This is the user name or user group name to which this firewall rule applies.
Source	This displays the source address object to which this firewall rule applies.
Destination	This displays the destination address object to which this firewall rule applies.

Table 109 Configuration > Firewall (continued)

LABEL	DESCRIPTION
Service	This displays the service object to which this firewall rule applies.
Access	This field displays whether the firewall silently discards packets (deny), discards packets and sends a TCP reset packet to the sender (reject) or permits the passage of packets (allow).
Log	This field shows you whether a log (and alert) is created when packets match this rule or not.
Apply	Click Apply to save your changes back to the ZyWALL.
Reset	Click Reset to return the screen to its last-saved settings.

22.2.2 The Firewall Add/Edit Screen

In the **Firewall** screen, click the **Edit** or **Add** icon to display the **Firewall Rule Edit** screen.

Figure 235 Configuration > Firewall > Add

The following table describes the labels in this screen.

Table 110 Configuration > Firewall > Add

LABEL	DESCRIPTION
Create new Object	Use to configure any new settings objects that you need to use in this screen.
Enable	Select this check box to activate the firewall rule.
From To	For through-ZyWALL rules, select the direction of travel of packets to which the rule applies. any means all interfaces or VPN tunnels. ZyWALL means packets destined for the ZyWALL itself.

Table 110 Configuration > Firewall > Add (continued)

LABEL	DESCRIPTION
Description	Enter a descriptive name of up to 60 printable ASCII characters for the firewall rule. Spaces are allowed.
Schedule	Select a schedule that defines when the rule applies. Otherwise, select none and the rule is always effective.
User	This field is not available when you are configuring a to-ZyWALL rule. Select a user name or user group to which to apply the rule. The firewall rule is activated only when the specified user logs into the system and the rule will be disabled when the user logs out. Otherwise, select any and there is no need for user logging. Note: If you specified a source IP address (group) instead of any in the field below, the user's IP address should be within the IP address range.
Source	Select a source address or address group for whom this rule applies. Select any if the policy is effective for every source.
Destination	Select a destination address or address group for whom this rule applies. Select any if the policy is effective for every destination.
Service	Select a service or service group from the drop-down list box.
Access	Use the drop-down list box to select what the firewall is to do with packets that match this rule. Select deny to silently discard the packets without sending a TCP reset packet or an ICMP destination-unreachable message to the sender. Select reject to deny the packets and send a TCP reset packet to the sender. Any UDP packets are dropped without sending a response packet. Select allow to permit the passage of the packets.
Log	Select whether to have the ZyWALL generate a log (log), log and alert (log alert) or not (no) when the rule is matched. See Chapter 44 on page 679 for more on logs.
OK	Click OK to save your customized settings and exit this screen.
Cancel	Click Cancel to exit this screen without saving.

22.3 The Session Limit Screen

Click **Configuration > Firewall > Session Limit** to display the **Firewall Session Limit** screen. Use this screen to limit the number of concurrent NAT/firewall sessions a client can use. You can apply a default limit for all users and

individual limits for specific users, addresses, or both. The individual limit takes priority if you apply both.

Figure 236 Configuration > Firewall > Session Limit

The screenshot shows the 'Session Limit' configuration page. Under 'General Settings', the 'Enable Session Limit' checkbox is checked, and the 'Default Session per Host' is set to 0. Below this is a 'Rule Summary' section with a table that is currently empty. The table has columns for Status, #, User, Address, Description, and Limit. At the bottom of the page are 'Apply' and 'Reset' buttons.

The following table describes the labels in this screen.

Table 111 Configuration > Firewall > Session Limit

LABEL	DESCRIPTION
General Settings	
Enable Session limit	Select this check box to control the number of concurrent sessions hosts can have.
Default Session per Host	Use this field to set a common limit to the number of concurrent NAT/firewall sessions each client computer can have. If only a few clients use peer to peer applications, you can raise this number to improve their performance. With heavy peer to peer application use, lower this number to ensure no single client uses too many of the available NAT sessions. Create rules below to apply other limits for specific users or addresses.
Rule Summary	This table lists the rules for limiting the number of concurrent sessions hosts can have.
Add	Click this to create a new entry. Select an entry and click Add to create a new entry after the selected entry.
Edit	Double-click an entry or select it and click Edit to open a screen where you can modify the entry's settings.
Remove	To remove an entry, select it and click Remove . The ZyWALL confirms you want to remove it before doing so.
Activate	To turn on an entry, select it and click Activate .
Inactivate	To turn off an entry, select it and click Inactivate .
Move	To change a rule's position in the numbered list, select the rule and click Move to display a field to type a number for where you want to put that rule and press [ENTER] to move the rule to the number that you typed. The ordering of your rules is important as they are applied in order of their numbering.
Status	This icon is lit when the entry is active and dimmed when the entry is inactive.

Table 111 Configuration > Firewall > Session Limit (continued)

LABEL	DESCRIPTION
#	This is the index number of a session limit rule. It is not associated with a specific rule.
User	This is the user name or user group name to which this session limit rule applies.
Address	This is the address object to which this session limit rule applies.
Limit	This is how many concurrent sessions this user or address is allowed to have.
Apply	Click Apply to save your changes back to the ZyWALL.
Reset	Click Reset to return the screen to its last-saved settings.

22.3.1 The Session Limit Add/Edit Screen

Click **Configuration > Firewall > Session Limit** and the **Add** or **Edit** icon to display the **Firewall Session Limit Edit** screen. Use this screen to configure rules that define a session limit for specific users or addresses.

Figure 237 Configuration > Firewall > Session Limit > Edit

The following table describes the labels in this screen.

Table 112 Configuration > Firewall > Session Limit > Edit

LABEL	DESCRIPTION
Create new Object	Use to configure any new settings objects that you need to use in this screen.
Enable Rule	Select this check box to turn on this session limit rule.
Description	Enter information to help you identify this rule. Use up to 64 printable ASCII characters. Spaces are allowed.

Table 112 Configuration > Firewall > Session Limit > Edit (continued)

LABEL	DESCRIPTION
User	<p>Select a user name or user group to which to apply the rule. The rule is activated only when the specified user logs into the system and the rule will be disabled when the user logs out.</p> <p>Otherwise, select any and there is no need for user logging.</p> <p>Note: If you specified an IP address (or address group) instead of any in the field below, the user's IP address should be within the IP address range.</p>
Address	<p>Select a source address or address group for whom this rule applies. Select any if the policy is effective for every source address.</p>
Session Limit per Host	<p>Use this field to set a limit to the number of concurrent NAT/firewall sessions this rule's users or addresses can have.</p> <p>For this rule's users and addresses, this setting overrides the Default Session per Host setting in the general Firewall Session Limit screen.</p>
OK	<p>Click OK to save your customized settings and exit this screen.</p>
Cancel	<p>Click Cancel to exit this screen without saving.</p>

IPSec VPN

23.1 IPSec VPN Overview

A virtual private network (VPN) provides secure communications between sites without the expense of leased site-to-site lines. A secure VPN is a combination of tunneling, encryption, authentication, access control and auditing. It is used to transport traffic over the Internet or any insecure network that uses TCP/IP for communication.

Internet Protocol Security (IPSec) is a standards-based VPN that offers flexible solutions for secure data communications across a public network like the Internet. IPSec is built around a number of standardized cryptographic techniques to provide confidentiality, data integrity and authentication at the IP layer. The following figure is an example of an IPSec VPN tunnel.

Figure 238 IPSec VPN Example

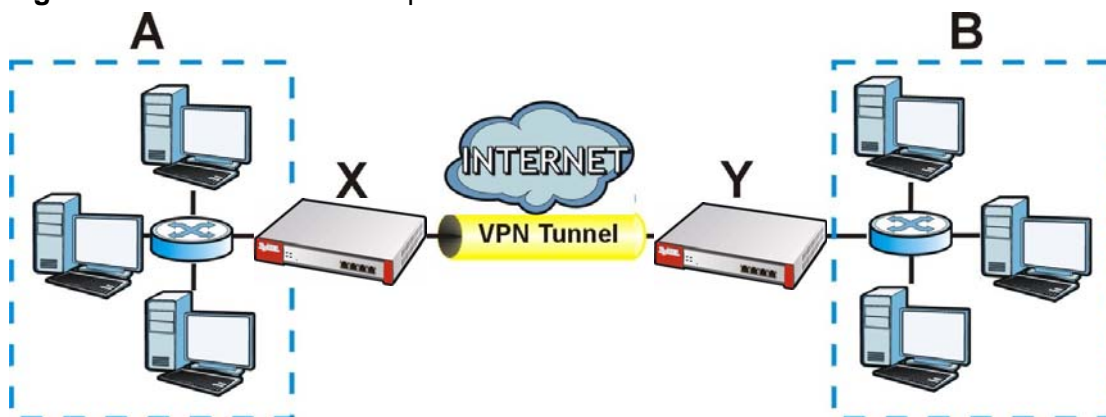

The VPN tunnel connects the ZyWALL (X) and the remote (peer) IPsec router (Y). These routers then connect the local network (A) and remote network (B).

23.1.1 What You Can Do in this Chapter

- Use the **VPN Connection** screens (see [Section 23.2 on page 394](#)) to specify which VPN gateway a VPN connection policy uses and which devices (behind the IPsec routers) can use the VPN tunnel and the IPsec SA settings (phase 2 settings). You can also activate / deactivate and connect / disconnect each VPN connection (each IPsec SA).

- Use the **VPN Gateway** screens (see [Section 23.2.1 on page 396](#)) to manage the ZyWALL's VPN gateways. A VPN gateway specifies the IPsec routers at either end of a VPN tunnel and the IKE SA settings (phase 1 settings). You can also activate and deactivate each VPN gateway.

23.1.2 What You Need to Know

An IPsec VPN tunnel is usually established in two phases. Each phase establishes a security association (SA), a contract indicating what security parameters the ZyWALL and the remote IPsec router will use. The first phase establishes an Internet Key Exchange (IKE) SA between the ZyWALL and remote IPsec router. The second phase uses the IKE SA to securely establish an IPsec SA through which the ZyWALL and remote IPsec router can send data between computers on the local network and remote network. This is illustrated in the following figure.

Figure 239 VPN: IKE SA and IPsec SA

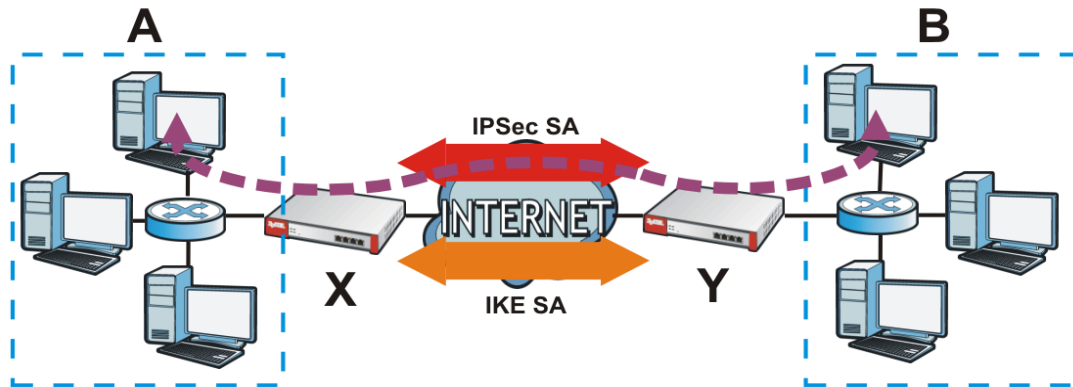





In this example, a computer in network **A** is exchanging data with a computer in network **B**. Inside networks **A** and **B**, the data is transmitted the same way data is normally transmitted in the networks. Between routers **X** and **Y**, the data is protected by tunneling, encryption, authentication, and other security features of the IPsec SA. The IPsec SA is secure because routers **X** and **Y** established the IKE SA first.

Application Scenarios

The ZyWALL's application scenarios make it easier to configure your VPN connection settings.

Table 113 IPsec VPN Application Scenarios

SITE-TO-SITE	SITE-TO-SITE WITH DYNAMIC PEER	REMOTE ACCESS (SERVER ROLE)	REMOTE ACCESS (CLIENT ROLE)
			
<p>Choose this if the remote IPsec router has a static IP address or a domain name.</p> <p>This ZyWALL can initiate the VPN tunnel.</p> <p>The remote IPsec router can also initiate the VPN tunnel if this ZyWALL has a static IP address or a domain name.</p>	<p>Choose this if the remote IPsec router has a dynamic IP address.</p> <p>You don't specify the remote IPsec router's address, but you specify the remote policy (the addresses of the devices behind the remote IPsec router).</p> <p>This ZyWALL must have a static IP address or a domain name.</p> <p>Only the remote IPsec router can initiate the VPN tunnel.</p>	<p>Choose this to allow incoming connections from IPsec VPN clients.</p> <p>The clients have dynamic IP addresses and are also known as dial-in users.</p> <p>You don't specify the addresses of the client IPsec routers or the remote policy.</p> <p>This creates a dynamic IPsec VPN rule that can let multiple clients connect.</p> <p>Only the clients can initiate the VPN tunnel.</p>	<p>Choose this to connect to an IPsec server.</p> <p>This ZyWALL is the client (dial-in user).</p> <p>Client role ZyWALLs initiate IPsec VPN connections to a server role ZyWALL.</p> <p>This ZyWALL can have a dynamic IP address.</p> <p>The IPsec server doesn't configure this ZyWALL's IP address or the addresses of the devices behind it.</p> <p>Only this ZyWALL can initiate the VPN tunnel.</p>

Finding Out More

- See [Section 6.5.14 on page 101](#) for related information on these screens.

- See [Section 23.4 on page 415](#) for IPSec VPN background information.
- See [Section 5.4 on page 76](#) for the IPSec VPN quick setup wizard.
- See [Section 7.4 on page 116](#) for an example of configuring IPSec VPN.

23.1.3 Before You Begin

This section briefly explains the relationship between VPN tunnels and other features. It also gives some basic suggestions for troubleshooting.

You should set up the following features before you set up the VPN tunnel.

- In any VPN connection, you have to select address objects to specify the local policy and remote policy. You should set up the address objects first.
- In a VPN gateway, you can select an Ethernet interface, virtual Ethernet interface, VLAN interface, or virtual VLAN interface to specify what address the ZyWALL uses as its IP address when it establishes the IKE SA. You should set up the interface first. See [Chapter 11 on page 217](#).
- In a VPN gateway, you can enable extended authentication. If the ZyWALL is in server mode, you should set up the authentication method (AAA server) first. The authentication method specifies how the ZyWALL authenticates the remote IPSec router. See [Chapter 37 on page 573](#).
- In a VPN gateway, the ZyWALL and remote IPSec router can use certificates to authenticate each other. Make sure the ZyWALL and the remote IPSec router will trust each other's certificates. See [Chapter 39 on page 589](#).

23.2 The VPN Connection Screen

Click **Configuration > VPN > IPSec VPN** to open the **VPN Connection** screen. The **VPN Connection** screen lists the VPN connection policies and their associated VPN gateway(s), and various settings. In addition, it also lets you activate / deactivate and connect / disconnect each VPN connection (each IPSec

SA). Click a column's heading cell to sort the table entries by that column's criteria. Click the heading cell again to reverse the sort order.

Figure 240 Configuration > VPN > IPsec VPN > VPN Connection

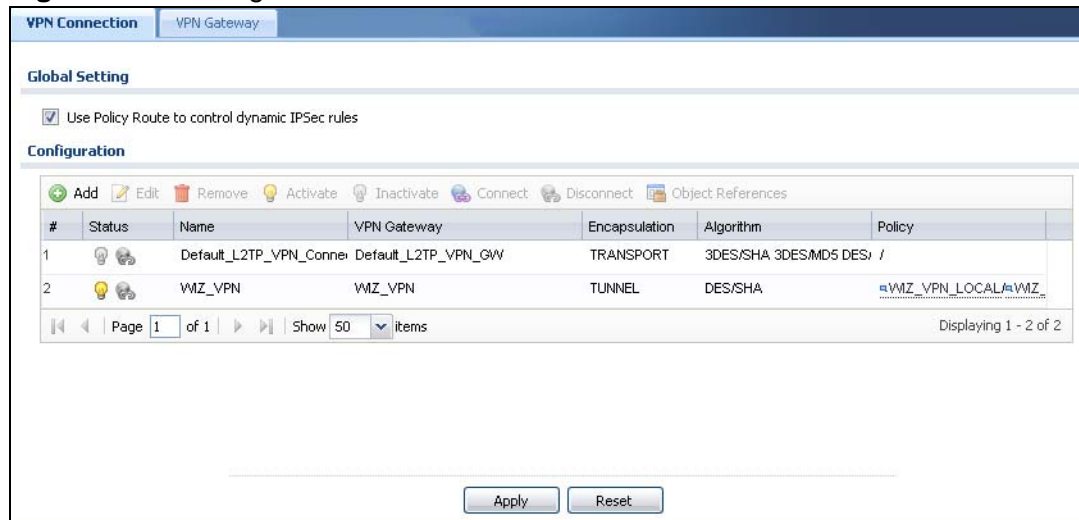

Each field is discussed in the following table. See [Section 23.2.2 on page 403](#) and [Section 23.2.1 on page 396](#) for more information.

Table 114 Configuration > VPN > IPsec VPN > VPN Connection

LABEL	DESCRIPTION
Use Policy Route to control dynamic IPsec rules	Select this to be able to use policy routes to manually specify the destination addresses of dynamic IPsec rules. You must manually create these policy routes. The ZyWALL automatically obtains source and destination addresses for dynamic IPsec rules that do not match any of the policy routes. Clear this to have the ZyWALL automatically obtain source and destination addresses for all dynamic IPsec rules. See Section 6.4.1 on page 92 for how this option affects the routing table.
Add	Click this to create a new entry.
Edit	Double-click an entry or select it and click Edit to open a screen where you can modify the entry's settings.
Remove	To remove an entry, select it and click Remove . The ZyWALL confirms you want to remove it before doing so.
Activate	To turn on an entry, select it and click Activate .
Inactivate	To turn off an entry, select it and click Inactivate .
Connect	To connect an IPsec SA, select it and click Connect .
Disconnect	To disconnect an IPsec SA, select it and click Disconnect .
#	This field is a sequential value, and it is not associated with a specific connection.

Table 114 Configuration > VPN > IPsec VPN > VPN Connection (continued)

LABEL	DESCRIPTION
Status	The activate (light bulb) icon is lit when the entry is active and dimmed when the entry is inactive. The connect icon is lit when the interface is connected and dimmed when it is disconnected.
Name	This field displays the name of the IPsec SA.
VPN Gateway	This field displays the associated VPN gateway(s). If there is no VPN gateway, this field displays "manual key".
Encapsulation	This field displays what encapsulation the IPsec SA uses.
Algorithm	This field displays what encryption and authentication methods, respectively, the IPsec SA uses.
Policy	This field displays the local policy and the remote policy, respectively.
Apply	Click Apply to save your changes back to the ZyWALL.
Reset	Click Reset to return the screen to its last-saved settings.

23.2.1 The VPN Connection Add/Edit (IKE) Screen

The **VPN Connection Add/Edit Gateway** screen allows you to create a new VPN connection policy or edit an existing one. To access this screen, go to the **Configuration > VPN Connection** screen (see [Section 23.2 on page 394](#)), and click either the **Add** icon or an **Edit** icon. If you click the **Add** icon, you have to select a specific VPN gateway in the **VPN Gateway** field before the following screen appears.

Figure 241 Configuration > VPN > IPsec VPN > VPN Connection > Edit (IKE)

Add VPN Connection

Hide Advance Settings Create new Object

General Settings

Enable
 Connection Name:
 Nailed-Up
 Enable Replay Detection
 Enable NetBIOS broadcast over IPsec

VPN Gateway

Application Scenario
 Site-to-site
 Site-to-site with Dynamic Peer
 Remote Access (Server Role)
 Remote Access (Client Role)

VPN Gateway: U/A
 Manual Key
 Manual Key
 My Address:
 Secure Gateway Address:
 SPI: (255 - 4095)
 Encapsulation Mode: Tunnel
 Active Protocol: ESP
 Encryption Algorithm: DES
 Authentication Algorithm: SHA1
 Encryption Key:
 Authentication Key:

Policy

Local policy: U/A
 Remote policy: U/A
 Policy Enforcement

Phase 2 Settings

SA Life Time: 86400 (180 - 3000000 Seconds)
 Active Protocol: ESP
 Encapsulation: Tunnel
 Proposal

#	Encryption	Authentication
1	DES	SHA1

 Perfect Forward Security (PFS): none

Related Settings

Add this VPN connection to IPsec_VPN zone.

Connectivity Check

Enable Connectivity Check
 Check Method: icmp
 Check Port: (1-65535)
 Check Period: 5 (5-30 Seconds)
 Check Timeout: 5 (1-10 Seconds)
 Check Fail Tolerance: (1-10)
 Check This Address: Domain Name or IP Address
 Check the First and Last IP Address in the Remote Policy
 Log

Inbound/Outbound traffic NAT

Outbound Traffic

Source NAT
 Source:
 Destination:
 SNAT:
Inbound Traffic

Source NAT
 Source:
 Destination:
 SNAT:
 Destination NAT

#	Original IP	Mapped IP	Protocol	Original Port S	Original Port E	Mapped Port S	Mapped Port E
No data to display							

Page 1 of 1 Show 50 items

OK Cancel

Each field is described in the following table.

Table 115 Configuration > VPN > IPsec VPN > VPN Connection > Edit

LABEL	DESCRIPTION
Show Advance Settings / Hide Advance Settings	Click this button to display a greater or lesser number of configuration fields.
Create new Object	Use to configure any new settings objects that you need to use in this screen.
General Settings	
Enable	Select this check box to activate this VPN connection.
Connection Name	Type the name used to identify this IPsec SA. You may use 1-31 alphanumeric characters, underscores(_), or dashes (-), but the first character cannot be a number. This value is case-sensitive.
Nailed-Up	Select this if you want the ZyWALL to automatically renegotiate the IPsec SA when the SA life time expires.
Enable Replay Detection	Select this check box to detect and reject old or duplicate packets to protect against Denial-of-Service attacks.
Enable NetBIOS Broadcast over IPsec	<p>Select this check box if you the ZyWALL to send NetBIOS (Network Basic Input/Output System) packets through the IPsec SA.</p> <p>NetBIOS packets are TCP or UDP packets that enable a computer to connect to and communicate with a LAN. It may sometimes be necessary to allow NetBIOS packets to pass through IPsec SAs in order to allow local computers to find computers on the remote network and vice versa.</p>
VPN Gateway	
Application Scenario	<p>Select the scenario that best describes your intended VPN connection.</p> <p>Site-to-site - Choose this if the remote IPsec router has a static IP address or a domain name. This ZyWALL can initiate the VPN tunnel.</p> <p>Site-to-site with Dynamic Peer - Choose this if the remote IPsec router has a dynamic IP address. Only the remote IPsec router can initiate the VPN tunnel.</p> <p>Remote Access (Server Role) - Choose this to allow incoming connections from IPsec VPN clients. The clients have dynamic IP addresses and are also known as dial-in users. Only the clients can initiate the VPN tunnel.</p> <p>Remote Access (Client Role) - Choose this to connect to an IPsec server. This ZyWALL is the client (dial-in user) and can initiate the VPN tunnel.</p>
VPN Gateway	Select the VPN gateway this VPN connection is to use or select Create Object to add another VPN gateway for this VPN connection to use.

Table 115 Configuration > VPN > IPsec VPN > VPN Connection > Edit (continued)

LABEL	DESCRIPTION
Manual Key	Select this option to configure a VPN connection policy that uses a manual key instead of IKE key management. This may be useful if you have problems with IKE key management. See Section 23.2.2 on page 403 for how to configure the manual key fields. Note: Only use manual key as a temporary solution, because it is not as secure as a regular IPsec SA.
Policy	
Local Policy	Select the address corresponding to the local network. Use Create new Object if you need to configure a new one.
Remote Policy	Select the address corresponding to the remote network. Use Create new Object if you need to configure a new one.
Policy Enforcement	Clear this to allow traffic with source and destination IP addresses that do not match the local and remote policy to use the VPN tunnel. Leave this cleared for free access between the local and remote networks. Selecting this restricts who can use the VPN tunnel. The ZyWALL drops traffic with source and destination IP addresses that do not match the local and remote policy.
Phase 2 Settings	
SA Life Time	Type the maximum number of seconds the IPsec SA can last. Shorter life times provide better security. The ZyWALL automatically negotiates a new IPsec SA before the current one expires, if there are users who are accessing remote resources.
Active Protocol	Select which protocol you want to use in the IPsec SA. Choices are: AH (RFC 2402) - provides integrity, authentication, sequence integrity (replay resistance), and non-repudiation but not encryption. If you select AH , you must select an Authentication algorithm. ESP (RFC 2406) - provides encryption and the same services offered by AH , but its authentication is weaker. If you select ESP , you must select an Encryption algorithm and Authentication algorithm. Both AH and ESP increase processing requirements and latency (delay). The ZyWALL and remote IPsec router must use the same active protocol.
Encapsulation	Select which type of encapsulation the IPsec SA uses. Choices are Tunnel - this mode encrypts the IP header information and the data. Transport - this mode only encrypts the data. The ZyWALL and remote IPsec router must use the same encapsulation.
Proposal	
Add	Click this to create a new entry.
Edit	Select an entry and click this to be able to modify it.

Table 115 Configuration > VPN > IPsec VPN > VPN Connection > Edit (continued)

LABEL	DESCRIPTION
Remove	Select an entry and click this to delete it.
#	This field is a sequential value, and it is not associated with a specific proposal. The sequence of proposals should not affect performance significantly.
Encryption	<p>This field is applicable when the Active Protocol is ESP. Select which key size and encryption algorithm to use in the IPsec SA. Choices are:</p> <p>NULL - no encryption key or algorithm</p> <p>DES - a 56-bit key with the DES encryption algorithm</p> <p>3DES - a 168-bit key with the DES encryption algorithm</p> <p>AES128 - a 128-bit key with the AES encryption algorithm</p> <p>AES192 - a 192-bit key with the AES encryption algorithm</p> <p>AES256 - a 256-bit key with the AES encryption algorithm</p> <p>The ZyWALL and the remote IPsec router must both have at least one proposal that uses use the same encryption and the same key.</p> <p>Longer keys are more secure, but require more processing power, resulting in increased latency and decreased throughput.</p>
Authentication	<p>Select which hash algorithm to use to authenticate packet data in the IPsec SA. Choices are SHA1 and MD5. SHA1 is generally considered stronger than MD5, but it is also slower.</p> <p>The ZyWALL and the remote IPsec router must both have a proposal that uses the same authentication algorithm.</p>
Perfect Forward Secrecy (PFS)	<p>Select whether or not you want to enable Perfect Forward Secrecy (PFS) and, if you do, which Diffie-Hellman key group to use for encryption. Choices are:</p> <p>none - disable PFS</p> <p>DH1 - enable PFS and use a 768-bit random number</p> <p>DH2 - enable PFS and use a 1024-bit random number</p> <p>DH5 - enable PFS and use a 1536-bit random number</p> <p>PFS changes the root key that is used to generate encryption keys for each IPsec SA. The longer the key, the more secure the encryption, but also the longer it takes to encrypt and decrypt information. Both routers must use the same DH key group.</p>
Related Settings	
Add this VPN connection to IPsec_VPN zone.	Select this check box to add the VPN connection policy to the IPsec_VPN security zone. Any security rules or settings configured for the IPsec_VPN security zone will also apply to this VPN connection policy.
Connectivity Check	The ZyWALL can regularly check the VPN connection to the gateway you specified to make sure it is still available.
Enable Connectivity Check	Select this to turn on the VPN connection check.

Table 115 Configuration > VPN > IPsec VPN > VPN Connection > Edit (continued)

LABEL	DESCRIPTION
Check Method	<p>Select how the ZyWALL checks the connection. The peer must be configured to respond to the method you select.</p> <p>Select icmp to have the ZyWALL regularly ping the address you specify to make sure traffic can still go through the connection. You may need to configure the peer to respond to pings.</p> <p>Select tcp to have the ZyWALL regularly perform a TCP handshake with the address you specify to make sure traffic can still go through the connection. You may need to configure the peer to accept the TCP connection.</p>
Check Port	This field displays when you set the Check Method to tcp . Specify the port number to use for a TCP connectivity check.
Check Period	Enter the number of seconds between connection check attempts.
Check Timeout	Enter the number of seconds to wait for a response before the attempt is a failure.
Check Fail Tolerance	Enter the number of consecutive failures allowed before the ZyWALL disconnects the VPN tunnel. The ZyWALL resumes using the first peer gateway address when the VPN connection passes the connectivity check.
Check this Address	Select this to specify a domain name or IP address for the connectivity check. Enter that domain name or IP address in the field next to it.
Check the First and Last IP Address in the Remote Policy	Select this to have the ZyWALL check the connection to the first and last IP addresses in the connection's remote policy. Make sure one of these is the peer gateway's LAN IP address.
Log	Select this to have the ZyWALL generate a log every time it checks this VPN connection.
Inbound/ Outbound traffic NAT	
Outbound Traffic	
Source NAT	This translation hides the source address of computers in the local network. It may also be necessary if you want the ZyWALL to route packets from computers outside the local network through the IPsec SA.
Source	Select the address object that represents the original source address (or select Create Object to configure a new one). This is the address object for the computer or network outside the local network. The size of the original source address range (Source) must be equal to the size of the translated source address range (SNAT).
Destination	Select the address object that represents the original destination address (or select Create Object to configure a new one). This is the address object for the remote network.
SNAT	Select the address object that represents the translated source address (or select Create Object to configure a new one). This is the address object for the local network. The size of the original source address range (Source) must be equal to the size of the translated source address range (SNAT).

Table 115 Configuration > VPN > IPsec VPN > VPN Connection > Edit (continued)

LABEL	DESCRIPTION
Inbound Traffic	
Source NAT	This translation hides the source address of computers in the remote network.
Source	Select the address object that represents the original source address (or select Create Object to configure a new one). This is the address object for the remote network. The size of the original source address range (Source) must be equal to the size of the translated source address range (SNAT).
Destination	Select the address object that represents the original destination address (or select Create Object to configure a new one). This is the address object for the local network.
SNAT	Select the address object that represents the translated source address (or select Create Object to configure a new one). This is the address that hides the original source address. The size of the original source address range (Source) must be equal to the size of the translated source address range (SNAT).
Destination NAT	This translation forwards packets (for example, mail) from the remote network to a specific computer (for example, the mail server) in the local network.
Add	Click this to create a new entry. Select an entry and click Add to create a new entry after the selected entry.
Edit	Select an entry and click this to be able to modify it.
Remove	Select an entry and click this to delete it.
Move	To change an entry's position in the numbered list, select it and click Move to display a field to type a number for where you want to put that entry and press [ENTER] to move the entry to the number that you typed.
#	This field is a sequential value, and it is not associated with a specific NAT record. However, the order of records is the sequence in which conditions are checked and executed.
Original IP	Select the address object that represents the original destination address. This is the address object for the remote network.
Mapped IP	Select the address object that represents the desired destination address. For example, this is the address object for the mail server.
Protocol	Select the protocol required to use this translation. Choices are: TCP , UDP , or All .
Original Port Start / Original Port End	These fields are available if the protocol is TCP or UDP . Enter the original destination port or range of original destination ports. The size of the original port range must be the same size as the size of the mapped port range.
Mapped Port Start / Mapped Port End	These fields are available if the protocol is TCP or UDP . Enter the translated destination port or range of translated destination ports. The size of the original port range must be the same size as the size of the mapped port range.
OK	Click OK to save the changes.
Cancel	Click Cancel to discard all changes and return to the main VPN screen.

23.2.2 The VPN Connection Add/Edit Manual Key Screen

The **VPN Connection Add/Edit Manual Key** screen allows you to create a new VPN connection or edit an existing one using a manual key. This is useful if you have problems with IKE key management. To access this screen, go to the **VPN Connection summary** screen (see [Section 23.2 on page 394](#)), and click either the **Add** icon or an existing manual key entry's **Edit** icon. In the VPN Gateway section of the screen, select **Manual Key**.

Note: Only use manual key as a temporary solution, because it is not as secure as a regular IPsec SA.

Figure 242 Configuration > VPN > IPsec VPN > VPN Connection > Add > Manual Key

The screenshot shows the 'Add VPN Connection' configuration window. Under 'General Settings', there is an 'Enable' checkbox and a 'Connection Name' field with a red dashed border and a warning icon. Under 'VPN Gateway', the 'Manual Key' radio button is selected. Below it are several fields: 'My Address', 'Secure Gateway Address', 'SPI' (with a range of 256-4095), 'Encapsulation Mode' (set to Tunnel), 'Active Protocol' (set to ESP), 'Encryption Algorithm' (set to DES), 'Authentication Algorithm' (set to SHA1), 'Encryption Key', and 'Authentication Key'.

This table describes labels specific to manual key configuration. See [Section 23.2 on page 394](#) for descriptions of the other fields.

Table 116 Configuration > VPN > IPsec VPN > VPN Connection > Add > Manual Key

LABEL	DESCRIPTION
Manual Key	
My Address	Type the IP address of the ZyWALL in the IPsec SA. 0.0.0.0 is invalid.

Table 116 Configuration > VPN > IPsec VPN > VPN Connection > Add > Manual Key (continued)

LABEL	DESCRIPTION
Secure Gateway Address	Type the IP address of the remote IPsec router in the IPsec SA.
SPI	Type a unique SPI (Security Parameter Index) between 256 and 4095. The SPI is used to identify the ZyWALL during authentication. The ZyWALL and remote IPsec router must use the same SPI.
Encapsulation Mode	Select which type of encapsulation the IPsec SA uses. Choices are Tunnel - this mode encrypts the IP header information and the data Transport - this mode only encrypts the data. You should only select this if the IPsec SA is used for communication between the ZyWALL and remote IPsec router. If you select Transport mode, the ZyWALL automatically switches to Tunnel mode if the IPsec SA is not used for communication between the ZyWALL and remote IPsec router. In this case, the ZyWALL generates a log message for this change. The ZyWALL and remote IPsec router must use the same encapsulation.
Active Protocol	Select which protocol you want to use in the IPsec SA. Choices are: AH (RFC 2402) - provides integrity, authentication, sequence integrity (replay resistance), and non-repudiation but not encryption. If you select AH , you must select an Authentication Algorithm . ESP (RFC 2406) - provides encryption and the same services offered by AH , but its authentication is weaker. If you select ESP , you must select an Encryption Algorithm and Authentication Algorithm . The ZyWALL and remote IPsec router must use the same protocol.
Encryption Algorithm	This field is applicable when the Active Protocol is ESP . Select which key size and encryption algorithm to use in the IPsec SA. Choices are: NULL - no encryption key or algorithm DES - a 56-bit key with the DES encryption algorithm 3DES - a 168-bit key with the DES encryption algorithm AES128 - a 128-bit key with the AES encryption algorithm AES192 - a 192-bit key with the AES encryption algorithm AES256 - a 256-bit key with the AES encryption algorithm The ZyWALL and the remote IPsec router must use the same algorithm and key. Longer keys require more processing power, resulting in increased latency and decreased throughput.
Authentication Algorithm	Select which hash algorithm to use to authenticate packet data in the IPsec SA. Choices are SHA1 and MD5 . SHA1 is generally considered stronger than MD5 , but it is also slower. The ZyWALL and remote IPsec router must use the same algorithm.

Table 116 Configuration > VPN > IPsec VPN > VPN Connection > Add > Manual Key (continued)

LABEL	DESCRIPTION
Encryption Key	<p>This field is applicable when you select an Encryption Algorithm. Enter the encryption key, which depends on the encryption algorithm.</p> <p>DES - type a unique key 8-32 characters long</p> <p>3DES - type a unique key 24-32 characters long</p> <p>AES128 - type a unique key 16-32 characters long</p> <p>AES192 - type a unique key 24-32 characters long</p> <p>AES256 - type a unique key 32 characters long</p> <p>You can use any alphanumeric characters or <code>;; `~!@#\$%^&*()_+\\{}':./<>=-"</code>.</p> <p>If you want to enter the key in hexadecimal, type "0x" at the beginning of the key. For example, "0x0123456789ABCDEF" is in hexadecimal format; in "0123456789ABCDEF" is in ASCII format. If you use hexadecimal, you must enter twice as many characters as listed above.</p> <p>The remote IPsec router must have the same encryption key.</p> <p>The ZyWALL ignores any characters above the minimum number of characters required by the algorithm. For example, if you enter 1234567890XYZ for a DES encryption key, the ZyWALL only uses 12345678. The ZyWALL still stores the longer key.</p>
Authentication Key	<p>Enter the authentication key, which depends on the authentication algorithm.</p> <p>MD5 - type a unique key 16-20 characters long</p> <p>SHA1 - type a unique key 20 characters long</p> <p>You can use any alphanumeric characters or <code>;; `~!@#\$%^&*()_+\\{}':./<>=-"</code>. If you want to enter the key in hexadecimal, type "0x" at the beginning of the key. For example, "0x0123456789ABCDEF" is in hexadecimal format; in "0123456789ABCDEF" is in ASCII format. If you use hexadecimal, you must enter twice as many characters as listed above.</p> <p>The remote IPsec router must have the same authentication key.</p> <p>The ZyWALL ignores any characters above the minimum number of characters required by the algorithm. For example, if you enter 12345678901234567890 for a MD5 authentication key, the ZyWALL only uses 1234567890123456. The ZyWALL still stores the longer key.</p>
OK	Click OK to save your settings and exit this screen.
Cancel	Click Cancel to exit this screen without saving.

23.3 The VPN Gateway Screen

The **VPN Gateway** summary screen displays the IPsec VPN gateway policies in the ZyWALL, as well as the ZyWALL's address, remote IPsec router's address, and associated VPN connections for each one. In addition, it also lets you activate and deactivate each VPN gateway.

To access this screen, click **Configuration > VPN > Network > IPsec VPN > VPN Gateway**. The following screen appears.

Figure 243 Configuration > VPN > IPsec VPN > VPN Gateway

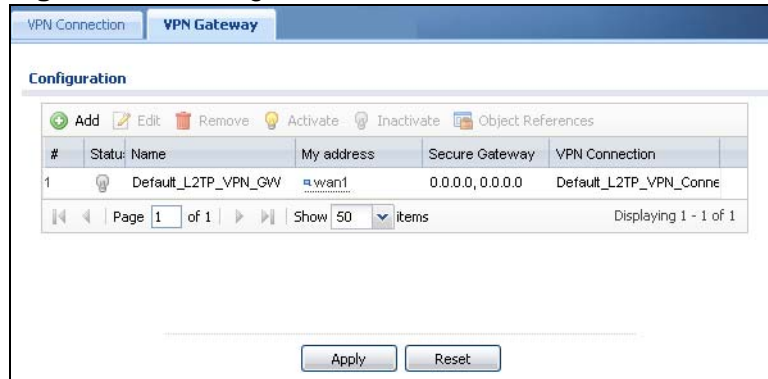

Each field is discussed in the following table. See [Section 23.3.1 on page 407](#) for more information.

Table 117 Configuration > VPN > IPsec VPN > VPN Gateway

LABEL	DESCRIPTION
Add	Click this to create a new entry.
Edit	Double-click an entry or select it and click Edit to open a screen where you can modify the entry's settings.
Remove	To remove an entry, select it and click Remove . The ZyWALL confirms you want to remove it before doing so.
Activate	To turn on an entry, select it and click Activate .
Inactivate	To turn off an entry, select it and click Inactivate .
Object References	Select an entry and click Object References to open a screen that shows which settings use the entry. See Section 11.3.2 on page 232 for an example.
#	This field is a sequential value, and it is not associated with a specific VPN gateway.
Status	The activate (light bulb) icon is lit when the entry is active and dimmed when the entry is inactive.
Name	This field displays the name of the VPN gateway
My address	This field displays the interface or a domain name the ZyWALL uses for the VPN gateway.
Secure Gateway	This field displays the IP address(es) of the remote IPsec routers.
VPN Connection	This field displays VPN connections that use this VPN gateway.

Table 117 Configuration > VPN > IPSec VPN > VPN Gateway (continued)

LABEL	DESCRIPTION
Apply	Click Apply to save your changes back to the ZyWALL.
Reset	Click Reset to return the screen to its last-saved settings.

23.3.1 The VPN Gateway Add/Edit Screen

The **VPN Gateway Add/Edit** screen allows you to create a new VPN gateway policy or edit an existing one. To access this screen, go to the **VPN Gateway summary** screen (see [Section 23.3 on page 406](#)), and click either the **Add** icon or an **Edit** icon.

Figure 244 Configuration > VPN > IPsec VPN > VPN Gateway > Edit

Each field is described in the following table.

Table 118 Configuration > VPN > IPsec VPN > VPN Gateway > Edit

LABEL	DESCRIPTION
Show Advance Settings / Hide Advance Settings	Click this button to display a greater or lesser number of configuration fields.
General Settings	
VPN Gateway Name	Type the name used to identify this VPN gateway. You may use 1-31 alphanumeric characters, underscores(_), or dashes (-), but the first character cannot be a number. This value is case-sensitive.
Gateway Settings	

Table 118 Configuration > VPN > IPsec VPN > VPN Gateway > Edit (continued)

LABEL	DESCRIPTION
My Address	<p>Select how the IP address of the ZyWALL in the IKE SA is defined.</p> <p>If you select Interface, select the Ethernet interface, VLAN interface, virtual Ethernet interface, virtual VLAN interface or PPPoE/PPTP interface. The IP address of the ZyWALL in the IKE SA is the IP address of the interface.</p> <p>If you select Domain Name / IP, enter the domain name or the IP address of the ZyWALL. The IP address of the ZyWALL in the IKE SA is the specified IP address or the IP address corresponding to the domain name. 0.0.0.0 is invalid.</p>
Peer Gateway Address	<p>Select how the IP address of the remote IPsec router in the IKE SA is defined.</p> <p>Select Static Address to enter the domain name or the IP address of the remote IPsec router. You can provide a second IP address or domain name for the ZyWALL to try if it cannot establish an IKE SA with the first one.</p> <p>Select Dynamic Address if the remote IPsec router has a dynamic IP address (and does not use DDNS).</p>
Authentication	<p>Note: The ZyWALL and remote IPsec router must use the same authentication method to establish the IKE SA.</p>
Pre-Shared Key	<p>Select this to have the ZyWALL and remote IPsec router use a pre-shared key (password) to identify each other when they negotiate the IKE SA. Type the pre-shared key in the field to the right. The pre-shared key can be</p> <ul style="list-style-type: none"> • 8 - 32 alphanumeric characters or , ; ` ~ ! @ # \$ % ^ & * () _ + \ { } ' : . / < > = - " . • 8 - 32 pairs of hexadecimal (0-9, A-F) characters, preceded by "0x". <p>If you want to enter the key in hexadecimal, type "0x" at the beginning of the key. For example, "0x0123456789ABCDEF" is in hexadecimal format; in "0123456789ABCDEF" is in ASCII format. If you use hexadecimal, you must enter twice as many characters since you need to enter pairs.</p> <p>The ZyWALL and remote IPsec router must use the same pre-shared key.</p>

Table 118 Configuration > VPN > IPsec VPN > VPN Gateway > Edit (continued)

LABEL	DESCRIPTION
Certificate	<p>Select this to have the ZyWALL and remote IPsec router use certificates to authenticate each other when they negotiate the IKE SA. Then select the certificate the ZyWALL uses to identify itself to the remote IPsec router.</p> <p>This certificate is one of the certificates in My Certificates. If this certificate is self-signed, import it into the remote IPsec router. If this certificate is signed by a CA, the remote IPsec router must trust that CA.</p> <p>Note: The IPsec routers must trust each other's certificates.</p> <p>The ZyWALL uses one of its Trusted Certificates to authenticate the remote IPsec router's certificate. The trusted certificate can be a self-signed certificate or that of a trusted CA that signed the remote IPsec router's certificate.</p>
Local ID Type	<p>This field is read-only if the ZyWALL and remote IPsec router use certificates to identify each other. Select which type of identification is used to identify the ZyWALL during authentication. Choices are:</p> <p>IP - the ZyWALL is identified by an IP address</p> <p>DNS - the ZyWALL is identified by a domain name</p> <p>E-mail - the ZyWALL is identified by an e-mail address</p>
Content	<p>This field is read-only if the ZyWALL and remote IPsec router use certificates to identify each other. Type the identity of the ZyWALL during authentication. The identity depends on the Local ID Type.</p> <p>IP - type an IP address; if you type 0.0.0.0, the ZyWALL uses the IP address specified in the My Address field. This is not recommended in the following situations:</p> <ul style="list-style-type: none"> • There is a NAT router between the ZyWALL and remote IPsec router. • You want the remote IPsec router to be able to distinguish between IPsec SA requests that come from IPsec routers with dynamic WAN IP addresses. <p>In these situations, use a different IP address, or use a different Local ID Type.</p> <p>DNS - type the domain name; you can use up to 31 ASCII characters including spaces, although trailing spaces are truncated. This value is only used for identification and can be any string.</p> <p>E-mail - the ZyWALL is identified by an e-mail address; you can use up to 31 ASCII characters including spaces, although trailing spaces are truncated. This value is only used for identification and can be any string.</p>

Table 118 Configuration > VPN > IPsec VPN > VPN Gateway > Edit (continued)

LABEL	DESCRIPTION
Peer ID Type	<p>Select which type of identification is used to identify the remote IPsec router during authentication. Choices are:</p> <p>IP - the remote IPsec router is identified by an IP address</p> <p>DNS - the remote IPsec router is identified by a domain name</p> <p>E-mail - the remote IPsec router is identified by an e-mail address</p> <p>Any - the ZyWALL does not check the identity of the remote IPsec router</p> <p>If the ZyWALL and remote IPsec router use certificates, there is one more choice.</p> <p>Subject Name - the remote IPsec router is identified by the subject name in the certificate</p>

Table 118 Configuration > VPN > IPsec VPN > VPN Gateway > Edit (continued)

LABEL	DESCRIPTION
Content	<p>This field is disabled if the Peer ID Type is Any. Type the identity of the remote IPsec router during authentication. The identity depends on the Peer ID Type.</p> <p>If the ZyWALL and remote IPsec router do not use certificates,</p> <p>IP - type an IP address; see the note at the end of this description.</p> <p>DNS - type the domain name; you can use up to 31 ASCII characters including spaces, although trailing spaces are truncated. This value is only used for identification and can be any string.</p> <p>E-mail - the ZyWALL is identified by an e-mail address; you can use up to 31 ASCII characters including spaces, although trailing spaces are truncated. This value is only used for identification and can be any string.</p> <p>If the ZyWALL and remote IPsec router use certificates, type the following fields from the certificate used by the remote IPsec router.</p> <p>IP - subject alternative name field; see the note at the end of this description.</p> <p>DNS - subject alternative name field</p> <p>E-mail - subject alternative name field</p> <p>Subject Name - subject name (maximum 255 ASCII characters, including spaces)</p> <p>Note: If Peer ID Type is IP, please read the rest of this section.</p> <p>If you type 0.0.0.0, the ZyWALL uses the IP address specified in the Secure Gateway Address field. This is not recommended in the following situations:</p> <ul style="list-style-type: none"> • There is a NAT router between the ZyWALL and remote IPsec router. • You want the remote IPsec router to be able to distinguish between IPsec SA requests that come from IPsec routers with dynamic WAN IP addresses. <p>In these situations, use a different IP address, or use a different Peer ID Type.</p>
Phase 1 Settings	
SA Life Time (Seconds)	Type the maximum number of seconds the IKE SA can last. When this time has passed, the ZyWALL and remote IPsec router have to update the encryption and authentication keys and re-negotiate the IKE SA. This does not affect any existing IPsec SAs, however.

Table 118 Configuration > VPN > IPsec VPN > VPN Gateway > Edit (continued)

LABEL	DESCRIPTION
Negotiation Mode	<p>Select the negotiation mode to use to negotiate the IKE SA. Choices are</p> <p>Main - this encrypts the ZyWALL's and remote IPsec router's identities but takes more time to establish the IKE SA</p> <p>Aggressive - this is faster but does not encrypt the identities</p> <p>The ZyWALL and the remote IPsec router must use the same negotiation mode.</p>
Proposal	
Add	Click this to create a new entry.
Edit	Select an entry and click this to be able to modify it.
Remove	Select an entry and click this to delete it.
#	This field is a sequential value, and it is not associated with a specific proposal. The sequence of proposals should not affect performance significantly.
Encryption	<p>Select which key size and encryption algorithm to use in the IKE SA. Choices are:</p> <p>DES - a 56-bit key with the DES encryption algorithm</p> <p>3DES - a 168-bit key with the DES encryption algorithm</p> <p>AES128 - a 128-bit key with the AES encryption algorithm</p> <p>AES192 - a 192-bit key with the AES encryption algorithm</p> <p>AES256 - a 256-bit key with the AES encryption algorithm</p> <p>The ZyWALL and the remote IPsec router must use the same key size and encryption algorithm. Longer keys require more processing power, resulting in increased latency and decreased throughput.</p>
Authentication	<p>Select which hash algorithm to use to authenticate packet data in the IPsec SA. Choices are SHA1 and MD5. SHA1 is generally considered stronger than MD5, but it is also slower.</p> <p>The remote IPsec router must use the same authentication algorithm.</p>
Key Group	<p>Select which Diffie-Hellman key group (DHx) you want to use for encryption keys. Choices are:</p> <p>DH1 - use a 768-bit random number</p> <p>DH2 - use a 1024-bit random number</p> <p>DH5 - use a 1536-bit random number</p> <p>The longer the key, the more secure the encryption, but also the longer it takes to encrypt and decrypt information. Both routers must use the same DH key group.</p>

Table 118 Configuration > VPN > IPsec VPN > VPN Gateway > Edit (continued)

LABEL	DESCRIPTION
NAT Traversal	<p>Select this if any of these conditions are satisfied.</p> <ul style="list-style-type: none"> This IKE SA might be used to negotiate IPsec SAs that use ESP as the active protocol. There are one or more NAT routers between the ZyWALL and remote IPsec router, and these routers do not support IPsec pass-thru or a similar feature. <p>The remote IPsec router must also enable NAT traversal, and the NAT routers have to forward packets with UDP port 500 and UDP 4500 headers unchanged.</p>
Dead Peer Detection (DPD)	<p>Select this check box if you want the ZyWALL to make sure the remote IPsec router is there before it transmits data through the IKE SA. The remote IPsec router must support DPD. If there has been no traffic for at least 15 seconds, the ZyWALL sends a message to the remote IPsec router. If the remote IPsec router responds, the ZyWALL transmits the data. If the remote IPsec router does not respond, the ZyWALL shuts down the IKE SA.</p> <p>If the remote IPsec router does not support DPD, see if you can use the VPN connection connectivity check (see Section 23.2.1 on page 396).</p>
More Settings/ Less Settings	Click this button to show or hide the Extended Authentication fields.
Extended Authentication	When multiple IPsec routers use the same VPN tunnel to connect to a single VPN tunnel (telecommuters sharing a tunnel for example), use extended authentication to enforce a user name and password check. This way even though they all know the VPN tunnel's security settings, each still has to provide a unique user name and password.
Enable Extended Authentication	Select this if one of the routers (the ZyWALL or the remote IPsec router) verifies a user name and password from the other router using the local user database and/or an external server.
Server Mode	Select this if the ZyWALL authenticates the user name and password from the remote IPsec router. You also have to select the authentication method, which specifies how the ZyWALL authenticates this information.
Client Mode	Select this radio button if the ZyWALL provides a username and password to the remote IPsec router for authentication. You also have to provide the User Name and the Password .
User Name	This field is required if the ZyWALL is in Client Mode for extended authentication. Type the user name the ZyWALL sends to the remote IPsec router. The user name can be 1-31 ASCII characters. It is case-sensitive, but spaces are not allowed.
Password	This field is required if the ZyWALL is in Client Mode for extended authentication. Type the password the ZyWALL sends to the remote IPsec router. The password can be 1-31 ASCII characters. It is case-sensitive, but spaces are not allowed.
OK	Click OK to save your settings and exit this screen.
Cancel	Click Cancel to exit this screen without saving.

23.4 IPsec VPN Background Information

Here is some more detailed IPsec VPN background information.

IKE SA Overview

The IKE SA provides a secure connection between the ZyWALL and remote IPsec router.

It takes several steps to establish an IKE SA. The negotiation mode determines how many. There are two negotiation modes--main mode and aggressive mode. Main mode provides better security, while aggressive mode is faster.

Note: Both routers must use the same negotiation mode.

These modes are discussed in more detail in [Negotiation Mode on page 419](#). Main mode is used in various examples in the rest of this section.

IP Addresses of the ZyWALL and Remote IPsec Router

To set up an IKE SA, you have to specify the IP addresses of the ZyWALL and remote IPsec router. You can usually enter a static IP address or a domain name for either or both IP addresses. Sometimes, your ZyWALL might offer another alternative, such as using the IP address of a port or interface, as well.

You can also specify the IP address of the remote IPsec router as 0.0.0.0. This means that the remote IPsec router can have any IP address. In this case, only the remote IPsec router can initiate an IKE SA because the ZyWALL does not know the IP address of the remote IPsec router. This is often used for telecommuters.

IKE SA Proposal

The IKE SA proposal is used to identify the encryption algorithm, authentication algorithm, and Diffie-Hellman (DH) key group that the ZyWALL and remote IPsec router use in the IKE SA. In main mode, this is done in steps 1 and 2, as illustrated next.

Figure 245 IKE SA: Main Negotiation Mode, Steps 1 - 2: IKE SA Proposal

- One or more proposals, each one consisting of:
- encryption algorithm
 - authentication algorithm
 - Diffie-Hellman key group

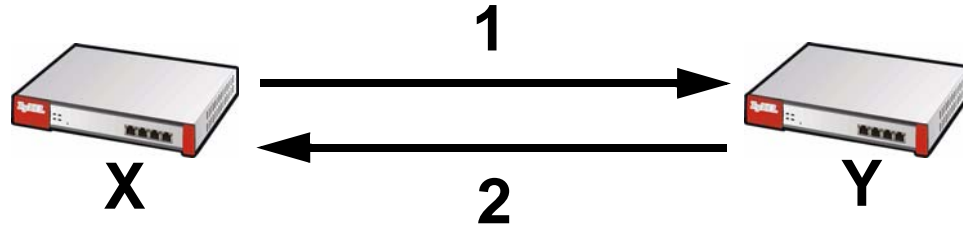

The ZyWALL sends one or more proposals to the remote IPsec router. (In some devices, you can only set up one proposal.) Each proposal consists of an encryption algorithm, authentication algorithm, and DH key group that the ZyWALL wants to use in the IKE SA. The remote IPsec router selects an acceptable proposal and sends the accepted proposal back to the ZyWALL. If the remote IPsec router rejects all of the proposals, the ZyWALL and remote IPsec router cannot establish an IKE SA.

Note: Both routers must use the same encryption algorithm, authentication algorithm, and DH key group.

In most ZyWALLs, you can select one of the following encryption algorithms for each proposal. The algorithms are listed in order from weakest to strongest.

- Data Encryption Standard (DES) is a widely used method of data encryption. It applies a 56-bit key to each 64-bit block of data.
- Triple DES (3DES) is a variant of DES. It iterates three times with three separate keys, effectively tripling the strength of DES.
- Advanced Encryption Standard (AES) is a newer method of data encryption that also uses a secret key. AES applies a 128-bit key to 128-bit blocks of data. It is faster than 3DES.

Some ZyWALLs also offer stronger forms of AES that apply 192-bit or 256-bit keys to 128-bit blocks of data.

In most ZyWALLs, you can select one of the following authentication algorithms for each proposal. The algorithms are listed in order from weakest to strongest.

- MD5 (Message Digest 5) produces a 128-bit digest to authenticate packet data.
- SHA1 (Secure Hash Algorithm) produces a 160-bit digest to authenticate packet data.

See [Diffie-Hellman \(DH\) Key Exchange on page 416](#) for more information about DH key groups.

Diffie-Hellman (DH) Key Exchange

The ZyWALL and the remote IPsec router use DH public-key cryptography to establish a shared secret. The shared secret is then used to generate encryption

keys for the IKE SA and IPsec SA. In main mode, this is done in steps 3 and 4, as illustrated next.

Figure 246 IKE SA: Main Negotiation Mode, Steps 3 - 4: DH Key Exchange

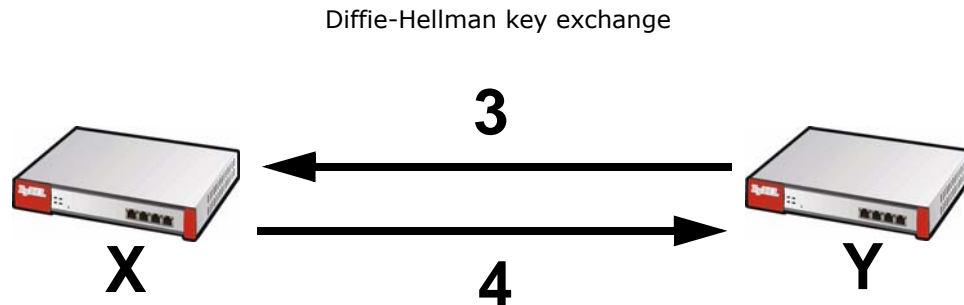

DH public-key cryptography is based on DH key groups. Each key group is a fixed number of bits long. The longer the key, the more secure the encryption, but also the longer it takes to encrypt and decrypt information. For example, DH2 keys (1024 bits) are more secure than DH1 keys (768 bits), but DH2 keys take longer to encrypt and decrypt.

Authentication

Before the ZyWALL and remote IPsec router establish an IKE SA, they have to verify each other's identity. This process is based on pre-shared keys and router identities.

In main mode, the ZyWALL and remote IPsec router authenticate each other in steps 5 and 6, as illustrated below. The identities are also encrypted using the encryption algorithm and encryption key the ZyWALL and remote IPsec router selected in previous steps.

Figure 247 IKE SA: Main Negotiation Mode, Steps 5 - 6: Authentication (continued)

Step 5:
pre-shared key
ZyWALL identity, consisting of
- ID type
- content
Step 6:
pre-shared key
Remote IPsec router identity, consisting of
- ID type
- content

You have to create (and distribute) a pre-shared key. The ZyWALL and remote IPsec router use it in the authentication process, though it is not actually transmitted or exchanged.

Note: The ZyWALL and the remote IPsec router must use the same pre-shared key.

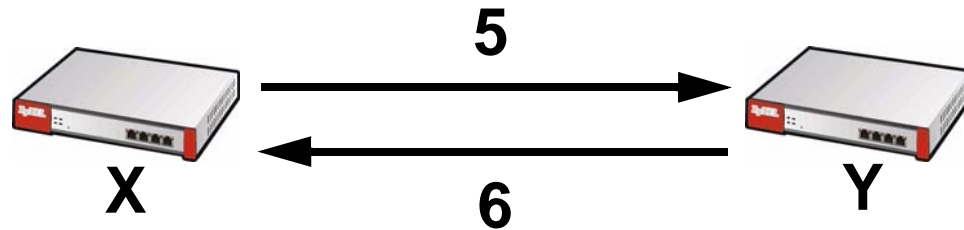

Router identity consists of ID type and content. The ID type can be domain name, IP address, or e-mail address, and the content is a (properly-formatted) domain name, IP address, or e-mail address. The content is only used for identification. Any domain name or e-mail address that you enter does not have to actually exist. Similarly, any domain name or IP address that you enter does not have to correspond to the ZyWALL's or remote IPsec router's properties.

The ZyWALL and the remote IPsec router have their own identities, so both of them must store two sets of information, one for themselves and one for the other router. Local ID type and content refers to the ID type and content that applies to the router itself, and peer ID type and content refers to the ID type and content that applies to the other router.

Note: The ZyWALL's local and peer ID type and content must match the remote IPsec router's peer and local ID type and content, respectively.

For example, in [Table 119 on page 418](#), the ZyWALL and the remote IPsec router authenticate each other successfully. In contrast, in [Table 120 on page 418](#), the ZyWALL and the remote IPsec router cannot authenticate each other and, therefore, cannot establish an IKE SA.

Table 119 VPN Example: Matching ID Type and Content

ZYWALL	REMOTE IPSEC ROUTER
Local ID type: E-mail	Local ID type: IP
Local ID content: tom@yourcompany.com	Local ID content: 1.1.1.2
Peer ID type: IP	Peer ID type: E-mail
Peer ID content: 1.1.1.2	Peer ID content: tom@yourcompany.com

Table 120 VPN Example: Mismatching ID Type and Content

ZYWALL	REMOTE IPSEC ROUTER
Local ID type: E-mail	Local ID type: IP
Local ID content: tom@yourcompany.com	Local ID content: 1.1.1.2
Peer ID type: IP	Peer ID type: E-mail
Peer ID content: 1.1.1.20	Peer ID content: tom@yourcompany.com

It is also possible to configure the ZyWALL to ignore the identity of the remote IPsec router. In this case, you usually set the peer ID type to **Any**. This is less secure, so you should only use this if your ZyWALL provides another way to check

the identity of the remote IPSec router (for example, extended authentication) or if you are troubleshooting a VPN tunnel.

Additional Topics for IKE SA

This section provides more information about IKE SA.

Negotiation Mode

There are two negotiation modes--main mode and aggressive mode. Main mode provides better security, while aggressive mode is faster.

Main mode takes six steps to establish an IKE SA.

Steps 1 - 2: The ZyWALL sends its proposals to the remote IPSec router. The remote IPSec router selects an acceptable proposal and sends it back to the ZyWALL.

Steps 3 - 4: The ZyWALL and the remote IPSec router exchange pre-shared keys for authentication and participate in a Diffie-Hellman key exchange, based on the accepted DH key group, to establish a shared secret.

Steps 5 - 6: Finally, the ZyWALL and the remote IPSec router generate an encryption key (from the shared secret), encrypt their identities, and exchange their encrypted identity information for authentication.

In contrast, aggressive mode only takes three steps to establish an IKE SA. Aggressive mode does not provide as much security because the identity of the ZyWALL and the identity of the remote IPSec router are not encrypted. It is usually used in remote-access situations, where the address of the initiator is not known by the responder and both parties want to use pre-shared keys for authentication. For example, the remote IPSec router may be a telecommuter who does not have a static IP address.

VPN, NAT, and NAT Traversal

In the following example, there is another router (A) between router X and router Y.

Figure 248 VPN/NAT Example

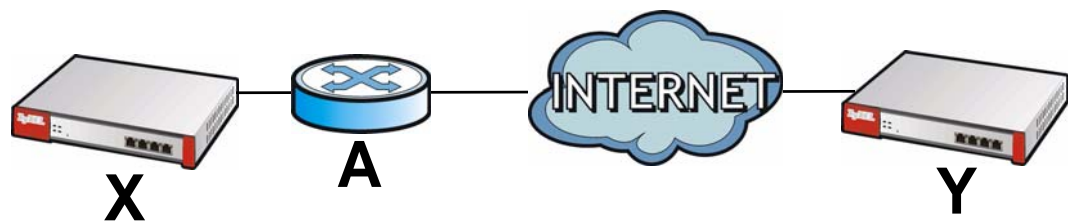

If router **A** does NAT, it might change the IP addresses, port numbers, or both. If router **X** and router **Y** try to establish a VPN tunnel, the authentication fails because it depends on this information. The routers cannot establish a VPN tunnel.

Most routers like router **A** now have an IPSec pass-thru feature. This feature helps router **A** recognize VPN packets and route them appropriately. If router **A** has this feature, router **X** and router **Y** can establish a VPN tunnel as long as the active protocol is ESP. (See [Active Protocol on page 421](#) for more information about active protocols.)

If router **A** does not have an IPSec pass-thru or if the active protocol is AH, you can solve this problem by enabling NAT traversal. In NAT traversal, router **X** and router **Y** add an extra header to the IKE SA and IPSec SA packets. If you configure router **A** to forward these packets unchanged, router **X** and router **Y** can establish a VPN tunnel.

You have to do the following things to set up NAT traversal.

- Enable NAT traversal on the ZyWALL and remote IPSec router.
- Configure the NAT router to forward packets with the extra header unchanged. (See the field description for detailed information about the extra header.)

The extra header may be UDP port 500 or UDP port 4500, depending on the standard(s) the ZyWALL and remote IPSec router support.

Extended Authentication

Extended authentication is often used when multiple IPSec routers use the same VPN tunnel to connect to a single IPSec router. For example, this might be used with telecommuters.

In extended authentication, one of the routers (the ZyWALL or the remote IPSec router) provides a user name and password to the other router, which uses a local user database and/or an external server to verify the user name and password. If the user name or password is wrong, the routers do not establish an IKE SA.

You can set up the ZyWALL to provide a user name and password to the remote IPSec router, or you can set up the ZyWALL to check a user name and password that is provided by the remote IPSec router.

If you use extended authentication, it takes four more steps to establish an IKE SA. These steps occur at the end, regardless of the negotiation mode (steps 7-10 in main mode, steps 4-7 in aggressive mode).

Certificates

It is possible for the ZyWALL and remote IPsec router to authenticate each other with certificates. In this case, you do not have to set up the pre-shared key, local identity, or remote identity because the certificates provide this information instead.

- Instead of using the pre-shared key, the ZyWALL and remote IPsec router check the signatures on each other's certificates. Unlike pre-shared keys, the signatures do not have to match.
- The local and peer ID type and content come from the certificates.

Note: You must set up the certificates for the ZyWALL and remote IPsec router first.

IPsec SA Overview

Once the ZyWALL and remote IPsec router have established the IKE SA, they can securely negotiate an IPsec SA through which to send data between computers on the networks.

Note: The IPsec SA stays connected even if the underlying IKE SA is not available anymore.

This section introduces the key components of an IPsec SA.

Local Network and Remote Network

In an IPsec SA, the local network, the one(s) connected to the ZyWALL, may be called the local policy. Similarly, the remote network, the one(s) connected to the remote IPsec router, may be called the remote policy.

Active Protocol

The active protocol controls the format of each packet. It also specifies how much of each packet is protected by the encryption and authentication algorithms. IPsec VPN includes two active protocols, AH (Authentication Header, RFC 2402) and ESP (Encapsulating Security Payload, RFC 2406).

Note: The ZyWALL and remote IPsec router must use the same active protocol.

Usually, you should select ESP. AH does not support encryption, and ESP is more suitable with NAT.

Encapsulation

There are two ways to encapsulate packets. Usually, you should use tunnel mode because it is more secure. Transport mode is only used when the IPsec SA is used for communication between the ZyWALL and remote IPsec router (for example, for remote management), not between computers on the local and remote networks.

Note: The ZyWALL and remote IPsec router must use the same encapsulation.

These modes are illustrated below.

Figure 249 VPN: Transport and Tunnel Mode Encapsulation

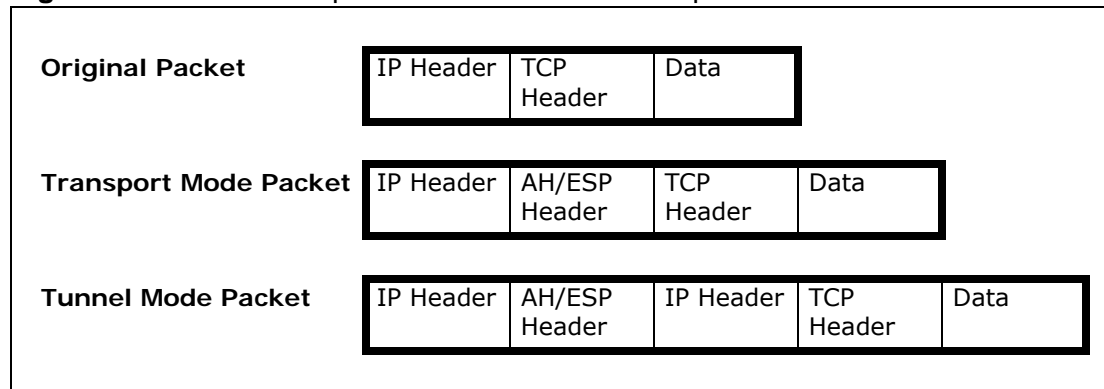

In tunnel mode, the ZyWALL uses the active protocol to encapsulate the entire IP packet. As a result, there are two IP headers:

- **Outside header:** The outside IP header contains the IP address of the ZyWALL or remote IPsec router, whichever is the destination.
- **Inside header:** The inside IP header contains the IP address of the computer behind the ZyWALL or remote IPsec router. The header for the active protocol (AH or ESP) appears between the IP headers.

In transport mode, the encapsulation depends on the active protocol. With AH, the ZyWALL includes part of the original IP header when it encapsulates the packet. With ESP, however, the ZyWALL does not include the IP header when it encapsulates the packet, so it is not possible to verify the integrity of the source IP address.

IPsec SA Proposal and Perfect Forward Secrecy

An IPsec SA proposal is similar to an IKE SA proposal (see [IKE SA Proposal on page 415](#)), except that you also have the choice whether or not the ZyWALL and remote IPsec router perform a new DH key exchange every time an IPsec SA is established. This is called Perfect Forward Secrecy (PFS).

If you enable PFS, the ZyWALL and remote IPsec router perform a DH key exchange every time an IPsec SA is established, changing the root key from which encryption keys are generated. As a result, if one encryption key is compromised, other encryption keys remain secure.

If you do not enable PFS, the ZyWALL and remote IPsec router use the same root key that was generated when the IKE SA was established to generate encryption keys.

The DH key exchange is time-consuming and may be unnecessary for data that does not require such security.

Additional Topics for IPsec SA

This section provides more information about IPsec SA in your ZyWALL.

IPsec SA using Manual Keys

You might set up an IPsec SA using manual keys when you want to establish a VPN tunnel quickly, for example, for troubleshooting. You should only do this as a temporary solution, however, because it is not as secure as a regular IPsec SA.

In IPsec SAs using manual keys, the ZyWALL and remote IPsec router do not establish an IKE SA. They only establish an IPsec SA. As a result, an IPsec SA using manual keys has some characteristics of IKE SA and some characteristics of IPsec SA. There are also some differences between IPsec SA using manual keys and other types of SA.

IPsec SA Proposal using Manual Keys

In an IPsec SA using manual keys, you can only specify one encryption algorithm and one authentication algorithm. You cannot specify several proposals. There is no DH key exchange, so you have to provide the encryption key and the authentication key the ZyWALL and remote IPsec router use.

Note: The ZyWALL and remote IPsec router must use the same encryption key and authentication key.

Authentication and the Security Parameter Index (SPI)

For authentication, the ZyWALL and remote IPsec router use the SPI, instead of pre-shared keys, ID type and content. The SPI is an identification number.

Note: The ZyWALL and remote IPsec router must use the same SPI.

NAT for Inbound and Outbound Traffic

The ZyWALL can translate the following types of network addresses in IPsec SA.

- Source address in outbound packets - this translation is necessary if you want the ZyWALL to route packets from computers outside the local network through the IPsec SA.
- Source address in inbound packets - this translation hides the source address of computers in the remote network.
- Destination address in inbound packets - this translation is used if you want to forward packets (for example, mail) from the remote network to a specific computer (like the mail server) in the local network.

Each kind of translation is explained below. The following example is used to help explain each one.

Figure 250 VPN Example: NAT for Inbound and Outbound Traffic

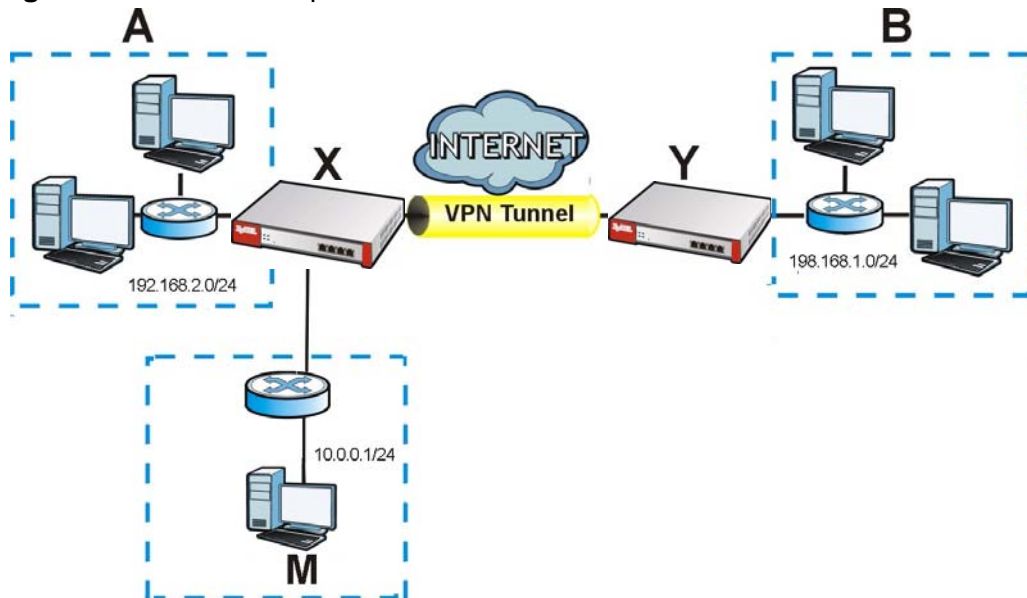

Source Address in Outbound Packets (Outbound Traffic, Source NAT)

This translation lets the ZyWALL route packets from computers that are not part of the specified local network (local policy) through the IPsec SA. For example, in [Figure 250 on page 424](#), you have to configure this kind of translation if you want computer **M** to establish a connection with any computer in the remote network (**B**). If you do not configure it, the remote IPsec router may not route messages for computer **M** through the IPsec SA because computer **M**'s IP address is not part of its local policy.

To set up this NAT, you have to specify the following information:

- Source - the original source address; most likely, computer **M**'s network.

- Destination - the original destination address; the remote network (**B**).
- SNAT - the translated source address; the local network (**A**).

Source Address in Inbound Packets (Inbound Traffic, Source NAT)

You can set up this translation if you want to change the source address of computers in the remote network. To set up this NAT, you have to specify the following information:

- Source - the original source address; the remote network (**B**).
- Destination - the original destination address; the local network (**A**).
- SNAT - the translated source address; a different IP address (range of addresses) to hide the original source address.

Destination Address in Inbound Packets (Inbound Traffic, Destination NAT)

You can set up this translation if you want the ZyWALL to forward some packets from the remote network to a specific computer in the local network. For example, in [Figure 250 on page 424](#), you can configure this kind of translation if you want to forward mail from the remote network to the mail server in the local network (**A**).

You have to specify one or more rules when you set up this kind of NAT. The ZyWALL checks these rules similar to the way it checks rules for a firewall. The first part of these rules define the conditions in which the rule apply.

- Original IP - the original destination address; the remote network (**B**).
- Protocol - the protocol [TCP, UDP, or both] used by the service requesting the connection.
- Original Port - the original destination port or range of destination ports; in [Figure 250 on page 424](#), it might be port 25 for SMTP.

The second part of these rules controls the translation when the condition is satisfied.

- Mapped IP - the translated destination address; in [Figure 250 on page 424](#), the IP address of the mail server in the local network (**A**).
- Mapped Port - the translated destination port or range of destination ports.

The original port range and the mapped port range must be the same size.

SSL VPN

24.1 Overview

Use SSL VPN to allow users to use a web browser for secure remote user login (the remote users do not need a VPN router or VPN client software).

24.1.1 What You Can Do in this Chapter

- Use the **VPN > SSL VPN > Access Privilege** screens (see [Section 24.2 on page 429](#)) to configure SSL access policies.
- Use the **Click VPN > SSL VPN > Global Setting** screen (see [Section 24.3 on page 433](#)) to set the IP address of the ZyWALL (or a gateway device) on your network for full tunnel mode access, enter access messages or upload a custom logo to be displayed on the remote user screen.

24.1.2 What You Need to Know

Full Tunnel Mode

In full tunnel mode, a virtual connection is created for remote users with private IP addresses in the same subnet as the local network. This allows them to access network resources in the same way as if they were part of the internal network.

Figure 251 Network Access Mode: Full Tunnel Mode

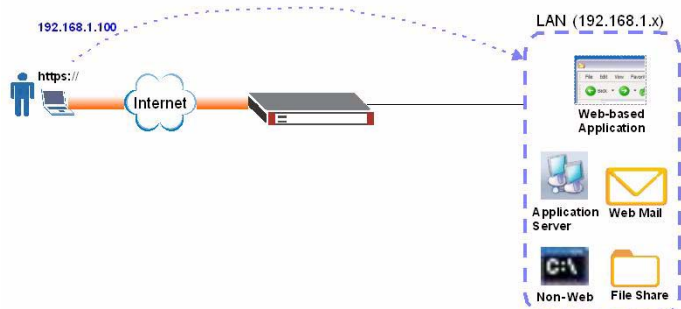

SSL Access Policy

An SSL access policy allows the ZyWALL to perform the following tasks:

- apply Endpoint Security (EPS) checking to require users' computers to comply with defined corporate policies before they can access the SSL VPN tunnel.
- limit user access to specific applications or files on the network.
- allow user access to specific networks.
- assign private IP addresses and provide DNS/WINS server information to remote users to access internal networks.

SSL Access Policy Objects

The SSL access policies reference the following objects. If you update this information, in response to changes, the ZyWALL automatically propagates the changes through the SSL policies that use the object(s). When you delete an SSL policy, the objects are not removed.

Table 121 Objects

OBJECT TYPE	OBJECT SCREEN	DESCRIPTION
User Accounts	User Account/ User Group	Configure a user account or user group to which you want to apply this SSL access policy.
Endpoint Security	Endpoint Security	Endpoint Security (EPS) checking makes sure users' computers comply with defined corporate policies before they can access the SSL VPN tunnel.
Application	SSL Application	Configure an SSL application object to specify the type of application and the address of the local computer, server, or web site SSL users are to be able to access.
IP Pool	Address	Configure an address object that defines a range of private IP addresses to assign to user computers so they can access the internal network through a VPN connection.
Server Addresses	Address	Configure address objects for the IP addresses of the DNS and WINS servers that the ZyWALL sends to the VPN connection users.
VPN Network	Address	Configure an address object to specify which network segment users are allowed to access through a VPN connection.

You cannot delete an object that is referenced by an SSL access policy. To delete the object, you must first unassociate the object from the SSL access policy.

Finding Out More

- See [Section 6.5.15 on page 101](#) for related information on these screens.
- See [Section 24.4 on page 435](#) for how to establish an SSL VPN connection to the ZyWALL (after you have configured the SSL VPN settings on the ZyWALL).
- See [Chapter 42 on page 621](#) for details on endpoint security objects.
- See [Chapter 41 on page 615](#) for details on SSL application objects.

24.2 The SSL Access Privilege Screen

Click **VPN > SSL VPN** to open the **Access Privilege** screen. This screen lists the configured SSL access policies.

Figure 252 VPN > SSL VPN > Access Privilege

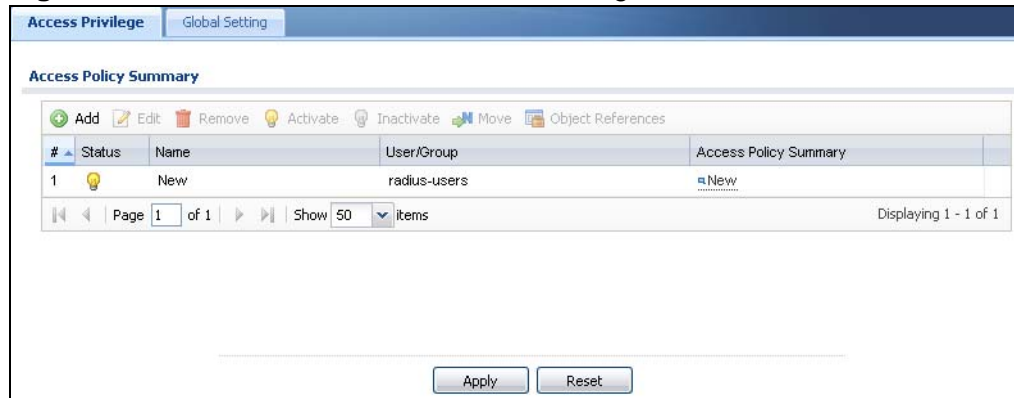

The following table describes the labels in this screen.

Table 122 VPN > SSL VPN > Access Privilege

LABEL	DESCRIPTION
Add	Click this to create a new entry. Select an entry and click Add to create a new entry after the selected entry.
Edit	Double-click an entry or select it and click Edit to open a screen where you can modify the entry's settings.
Remove	To remove an entry, select it and click Remove . The ZyWALL confirms you want to remove it before doing so.
Activate	To turn on an entry, select it and click Activate .
Inactivate	To turn off an entry, select it and click Inactivate .
Move	To move an entry to a different number in the list, click the Move icon. In the field that appears, specify the number to which you want to move the interface.
Object References	Select an entry and click Object References to open a screen that shows which settings use the entry. See Section 11.3.2 on page 232 for an example.
#	This field displays the index number of the entry.
Status	This icon is lit when the entry is active and dimmed when the entry is inactive.
Name	This field displays the descriptive name of the SSL access policy for identification purposes.
User/Group	This field displays the user account or user group name(s) associated to an SSL access policy. This field displays up to three names.
Access Policy Summary	This field displays details about the SSL application object this policy uses including its name, type, and address.

Table 122 VPN > SSL VPN > Access Privilege

LABEL	DESCRIPTION
Apply	Click Apply to save the settings.
Reset	Click Reset to discard all changes.

24.2.1 The SSL Access Policy Add/Edit Screen

To create a new or edit an existing SSL access policy, click the **Add** or **Edit** icon in the **Access Privilege** screen.

Figure 253 VPN > SSL VPN > Access Privilege > Add/Edit

Add Access Policy

Create new Object ▾

Configuration

Enable Policy

Name:

Description: (Optional)

Clean browser cache when user logs out: ⓘ

User/Group

Selectable User/Group Objects
=== Object ===

- admin
- ldap-users
- radius-users
- ad-users
- guest

Selected User/Group Objects

Endpoint Security (EPS)

Enable EPS Checking

Periodical checking time: (1-1440 minutes)

Selectable EPS Objects

Selected EPS Objects

Endpoint needs to match at least one EPS object.

SSL Application List (Optional)

Selectable Application Objects

Selected Application Objects

Network Extension (Optional)

Enable Network Extension

Assign IP Pool:

DNS Server 1:

DNS Server 2:

WINS Server 1:

WINS Server 2:

Network List

Selectable Address Objects

- LAN1_SUBNET
- LAN2_SUBNET
- DMZ_SUBNET

Selected Address Objects

Apply Reset OK Cancel

The following table describes the labels in this screen.

Table 123 VPN > SSL VPN > Access Privilege > Add/Edit

LABEL	DESCRIPTION
Create new Object	Use to configure any new settings objects that you need to use in this screen.
Configuration	
Enable Policy	Select this option to activate this SSL access policy.
Name	Enter a descriptive name to identify this policy. You can enter up to 15 characters ("a-z", "A-Z", "0-9") with no spaces allowed.
Description	Enter additional information about this SSL access policy. You can enter up to 31 characters ("0-9", "a-z", "A-Z", "-" and "_").
Clean browser cache when user logs out	Select this to clean the cookie, history, and temporary Internet files in the user's browser's cache when the user logs out. The ZyWALL returns them to the values present before the user logged in.
User/Group	<p>The Selectable User/Group Objects list displays the name(s) of the user account and/or user group(s) to which you have not applied an SSL access policy yet.</p> <p>To associate a user or user group to this SSL access policy, select a user account or user group and click >> to add to the Selected User/Group Objects list. You can select more than one name.</p> <p>To remove a user or user group, select the name(s) in the Selected User/Group Objects list and click <<.</p> <p>Note: Although you can select admin and limited-admin accounts in this screen, they are reserved for device configuration only. You cannot use them to access the SSL VPN portal.</p>
Endpoint Security (EPS)	Use these fields to make sure users' computers meet an endpoint security object's Operating System (OS) and security requirements before granting access.
Enable EPS Checking	Select this to have the ZyWALL check that users' computers meet the Operating System (OS) and security requirements of one of the SSL access policy's selected endpoint security objects before granting access.
Periodical checking time	Select this and specify a number of minutes to have the ZyWALL repeat the endpoint security check at a regular interval.

Table 123 VPN > SSL VPN > Access Privilege > Add/Edit (continued)

LABEL	DESCRIPTION
Available EPS Objects / Selected EPS Objects	<p>Configured endpoint security objects appear on the left. Select the endpoint security objects to use for this SSL access policy and click the right arrow button to add them to the selected list on the right. Use the [Shift] and/or [Ctrl] key to select multiple objects. Select any endpoint security objects that you want to remove from the selected list and click the left arrow button to remove them.</p> <p>The ZyWALL checks authenticated users' computers against the SSL access policy's selected endpoint security objects in the order you list them here. When a user's computer matches an endpoint security object the ZyWALL grants access and stops checking. Select an endpoint security object and use the up and down arrows to change its position in the list. To make the endpoint security check as efficient as possible, arrange the endpoint security objects in order with the one that the most users should match first and the one that the least users should match last.</p>
SSL Application List (Optional)	<p>The Selectable Application Objects list displays the name(s) of the SSL application(s) you can select for this SSL access policy.</p> <p>To associate an SSL application to this SSL access policy, select a name and click >> to add to the Selected Application Objects list. You can select more than one application.</p> <p>To remove an SSL application, select the name(s) in the Selected Application Objects list and click <<.</p>
Network Extension (Optional)	
Enable Network Extension	<p>Select this option to create a VPN tunnel between the authenticated users and the internal network. This allows the users to access the resources on the network as if they were on the same local network.</p> <p>Clear this option to disable this feature. Users can only access the applications as defined by the selected SSL application settings and the remote user computers are not made to be a part of the local network.</p>
Assign IP Pool	<p>Define a separate pool of IP addresses to assign to the SSL users. Select it here.</p> <p>The SSL VPN IP pool cannot overlap with IP addresses on the ZyWALL's local networks (LAN and DMZ for example), the SSL user's network, or the networks you specify in the SSL VPN Network List.</p>
DNS/WINS Server 1..2	<p>Select the name of the DNS or WINS server whose information the ZyWALL sends to the remote users. This allows them to access devices on the local network using domain names instead of IP addresses.</p>
Network List	<p>To allow user access to local network(s), select a network name in the Selectable Address Objects list and click >> to add to the Selected Address Objects list. You can select more than one network.</p> <p>To block access to a network, select the network name in the Selected Address Objects list and click <<.</p>
OK	<p>Click Ok to save the changes and return to the main Access Privilege screen.</p>
Cancel	<p>Click Cancel to discard all changes and return to the main Access Privilege screen.</p>

24.3 The SSL Global Setting Screen

Click **VPN > SSL VPN** and click the **Global Setting** tab to display the following screen. Use this screen to set the IP address of the ZyWALL (or a gateway device) on your network for full tunnel mode access, enter access messages or upload a custom logo to be displayed on the remote user screen.

Figure 254 VPN > SSL VPN > Global Setting

The following table describes the labels in this screen.

Table 124 VPN > SSL VPN > Global Setting

LABEL	DESCRIPTION
Global Setting	
Network Extension Local IP	Specify the IP address of the ZyWALL (or a gateway device) for full tunnel mode SSL VPN access. Leave this field to the default settings unless it conflicts with another interface.
SSL VPN Login Domain Name	
SSL VPN Login Domain Name 1/2	Specify a domain name for users to use for SSL VPN login. The domain name must be registered to one of the ZyWALL's IP addresses or be one of the ZyWALL's DDNS entries. You can specify up to two domain names so you could use one domain name for each of two WAN ports. Do not include the host. For example, www.zyxel.com is a fully qualified domain name where "www" is the host; so you would just use "zyxel.com". The ZyWALL displays the normal login screen without the button for logging into the Web Configurator.

Table 124 VPN > SSL VPN > Global Setting (continued)

LABEL	DESCRIPTION
Message	
Login Message	Specify a message to display on the screen when a user logs in and an SSL VPN connection is established successfully. You can enter up to 60 characters ("a-z", "A-Z", "0-9") with spaces allowed.
Logout Message	Specify a message to display on the screen when a user logs out and the SSL VPN connection is terminated successfully. You can enter up to 60 characters ("a-z", "A-Z", "0-9") with spaces allowed.
Update Client Virtual Desktop Logo	<p>You can upload a graphic logo to be displayed on the web browser on the remote user computer. The ZyXEL company logo is the default logo.</p> <p>Specify the location and file name of the logo graphic or click Browse to locate it.</p> <p>Note: The logo graphic must be GIF, JPG, or PNG format. The graphic should use a resolution of 127 x 57 pixels to avoid distortion when displayed. The ZyWALL automatically resizes a graphic of a different resolution to 127 x 57 pixels. The file size must be 100 kilobytes or less. Transparent background is recommended.</p>
Browse	Click Browse to locate the graphic file on your computer.
Upload	Click Upload to transfer the specified graphic file from your computer to the ZyWALL.
Reset Logo to Default	Click Reset Logo to Default to display the ZyXEL company logo on the remote user's web browser.
Apply	Click Apply to save the changes and/or start the logo file upload process.
Reset	Click Reset to return the screen to its last-saved settings.

24.3.1 How to Upload a Custom Logo

Follow the steps below to upload a custom logo to display on the remote user SSL VPN screens.

- 1 Click **VPN > SSL VPN** and click the **Global Setting** tab to display the configuration screen.
- 2 Click **Browse** to locate the logo graphic. Make sure the file is in GIF, JPG, or PNG format.
- 3 Click **Apply** to start the file transfer process.
- 4 Log in as a user to verify that the new logo displays properly.

The following shows an example logo on the remote user screen.

Figure 255 Example Logo Graphic Display

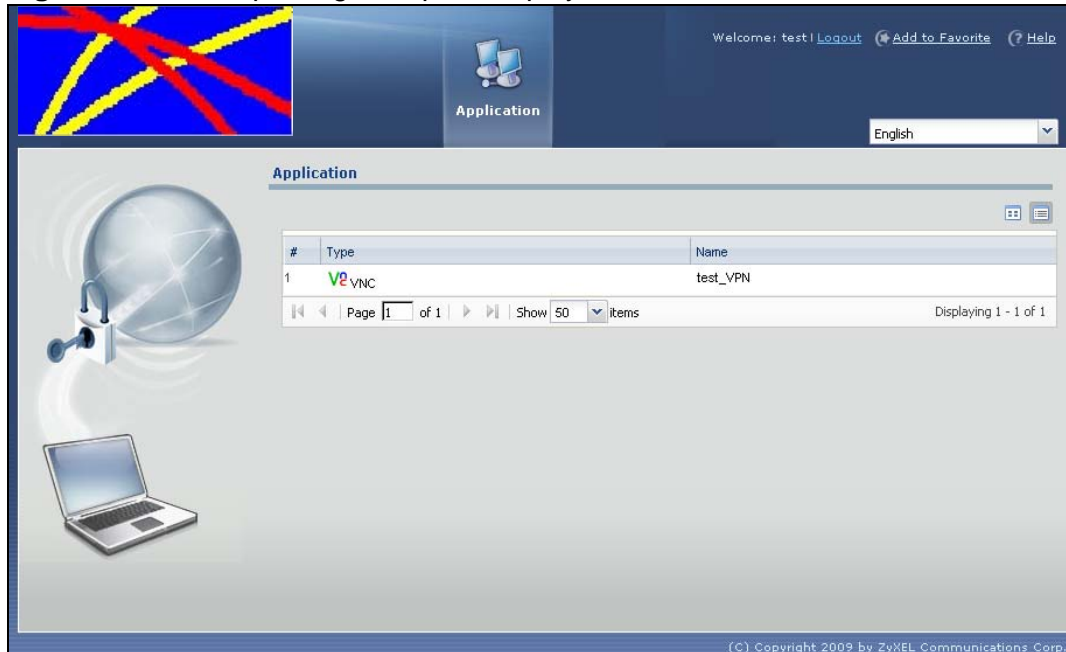

24.4 Establishing an SSL VPN Connection

After you have configured the SSL VPN settings on the ZyWALL, use the ZyWALL login screen's SSL VPN button to establish an SSL VPN connection. See [Section 25.2 on page 438](#) for details.

- 1 Display the ZyWALL's login screen and enter your user account information (the user name and password). Click **SSL VPN**.

Figure 256 Login Screen

The screenshot shows the ZyWALL login screen with a light blue background. At the top, it says "Enter User Name/Password and click to login." Below this are three input fields: "User Name:", "Password:", and "One-Time Password: (Optional)". Under the "One-Time Password" field, there is a note: "(max. 31 alphanumeric, printable characters and no spaces)". At the bottom, there are two buttons: "Login" and "SSL VPN".

- 2 SSL VPN connection starts. This may take several minutes depending on your network connection. Once the connection is up, you should see the client portal screen. The following shows an example.

Figure 257 SSL VPN Client Portal Screen Example

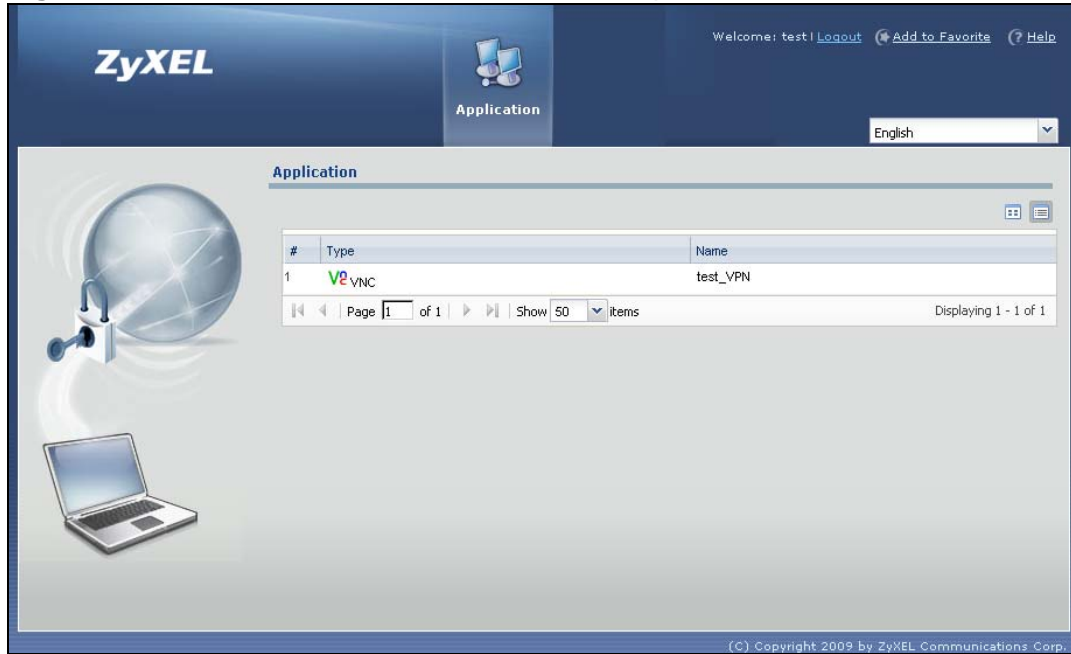

If the user account is not set up for SSL VPN access, an “SSL VPN connection is not activated” message displays in the **Login** screen. Clear the **Login to SSL VPN** check box and try logging in again.

For more information on user portal screens, refer to [Chapter 25 on page 437](#).

SSL User Screens

25.1 Overview

This chapter introduces the remote user SSL VPN screens. The following figure shows a network example where a remote user (A) logs into the ZyWALL from the Internet to access the web server (WWW) on the local network.

Figure 258 Network Example

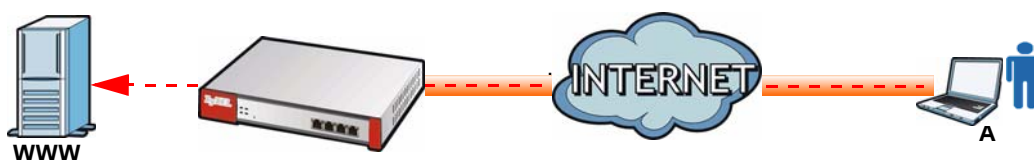

25.1.1 What You Need to Know

The ZyWALL can use SSL VPN to provide secure connections to network resources such as applications, files, intranet sites or e-mail through a web-based interface and using Microsoft Outlook Web Access (OWA).

Network Resource Access Methods

As a remote user, you can access resources on the local network using one of the following methods.

- Using a supported web browser
Once you have successfully logged in through the ZyWALL, you can access intranet sites, web-based applications, or web-based e-mails using one of the supported web browsers.
- Using the ZyWALL SecuExtender client
Once you have successfully logged into the ZyWALL, the ZyWALL automatically loads the ZyWALL SecuExtender client program to your computer. With the ZyWALL SecuExtender, you can access network resources, remote desktops and manage files as if you were on the local network. See [Chapter 27 on page 449](#) for more on the ZyWALL SecuExtender.

System Requirements

Here are the browser and computer system requirements for remote user access.

- Windows 7 (32 or 64-bit), Vista (32 or 64-bit), 2003 (32-bit), XP (32-bit), or 2000 (32-bit)
- Internet Explorer 7 and above or Firefox 1.5 and above
- Using RDP requires Internet Explorer
- Sun's Java (Java Runtime Environment or 'JRE') installed and enabled with a minimum version of 1.6.

Required Information

A remote user needs the following information from the network administrator to log in and access network resources.

- the domain name or IP address of the ZyWALL
- the login account user name and password
- if also required, the user name and/or password to access the network resource

Certificates

The remote user's computer establishes an HTTPS connection to the ZyWALL to access the login screen. If instructed by your network administrator, you must install or import a certificate (provided by the ZyWALL or your network administrator). Refer to [Appendix D on page 819](#) for more information.

Finding Out More

See [Chapter 24 on page 427](#) for how to configure SSL VPN on the ZyWALL.

25.2 Remote User Login

This section shows you how to access and log into the network through the ZyWALL. Example screens for Internet Explorer are shown.

- 1 Open a web browser and enter the web site address or IP address of the ZyWALL. For example, "http://sslvpn.mycompany.com".

Figure 259 Enter the Address in a Web Browser



- 2 Click **OK** or **Yes** if a security screen displays.

Figure 260 Login Security Screen



- 3 A login screen displays. Enter the user name and password of your login account. If a token password is also required, enter it in the **One-Time Password** field.
- 4 Click **SSL VPN** to log in and establish an SSL VPN connection to the network to access network resources.

Figure 261 Login Screen

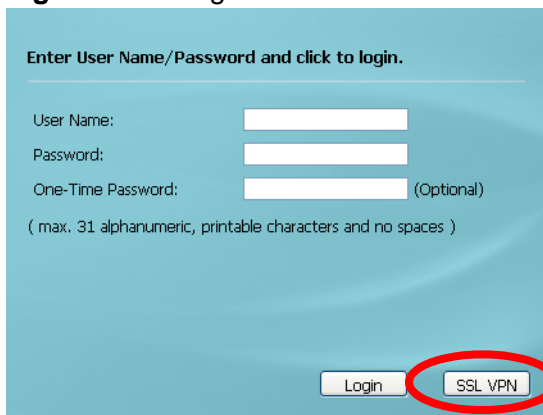

- 5 Your computer starts establishing a secure connection to the ZyWALL after a successful login. This may take up to two minutes. If you get a message about needing Java, download and install it and restart your browser and re-login. If a certificate warning screen displays, click **OK**, **Yes** or **Continue**.

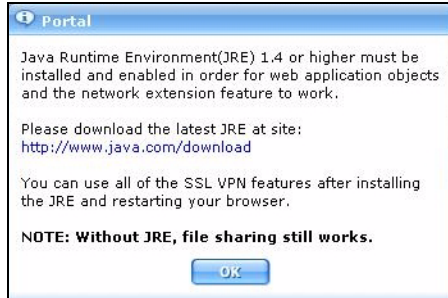
Figure 262 Java Needed Message

- 6 The ZyWALL tries to install the SecuExtender client. As shown next, you may have to click some pop-ups to get your browser to allow the installation.

Figure 263 ActiveX Object Installation Blocked by Browser

- 7 The ZyWALL tries to install the SecuExtender client. You may need to click a pop-up to get your browser to allow this. In Internet Explorer, click **Install**.

Figure 264 SecuExtender Blocked by Internet Explorer



- 8 The ZyWALL tries to run the "ssltun" application. You may need to click something to get your browser to allow this. In Internet Explorer, click **Run**.

Figure 265 SecuExtender Progress

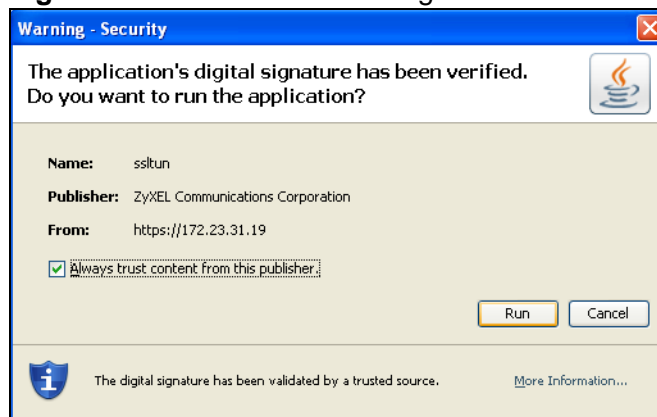

- 9 Click **Next** to use the setup wizard to install the SecuExtender client on your computer.

Figure 266 SecuExtender Progress



- 10 If a screen like the following displays, click **Continue Anyway** to finish installing the SecuExtender client on your computer.

Figure 267 Hardware Installation Warning



- 11 The **Application** screen displays showing the list of resources available to you. See [Figure 268 on page 443](#) for a screen example.

Note: Available resource links vary depending on the configuration your network administrator made.

25.3 The SSL VPN User Screens

This section describes the main elements in the remote user screens.

Figure 268 Remote User Screen



The following table describes the various parts of a remote user screen.

Table 125 Remote User Screen Overview

#	DESCRIPTION
1	Click on a menu tab to go to the Application screen.
2	Click this icon to log out and terminate the secure connection.
3	Click this icon to create a bookmark to the SSL VPN user screen in your web browser.
4	Click this icon to display the on-line help window.
5	Select your preferred language for the interface.
6	This part of the screen displays a list of the resources available to you. In the Application screen, click on a link to access or display the access method.

25.4 Bookmarking the ZyWALL

You can create a bookmark of the ZyWALL by clicking the **Add to Favorite** icon. This allows you to access the ZyWALL using the bookmark without having to enter the address every time.

- 1 In any remote user screen, click the **Add to Favorite** icon.
- 2 A screen displays. Accept the default name in the **Name** field or enter a descriptive name to identify this link.
- 3 Click **OK** to create a bookmark in your web browser.

Figure 269 Add Favorite

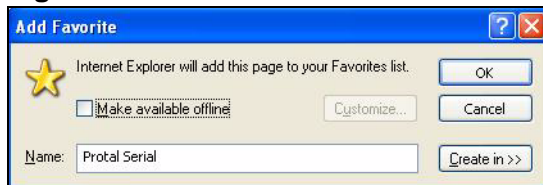

25.5 Logging Out of the SSL VPN User Screens

To properly terminate a connection, click on the **Logout** icon in any remote user screen.

- 1 Click the **Logout** icon in any remote user screen.
- 2 A prompt window displays. Click **OK** to continue.

Figure 270 Logout: Prompt



- 3 An information screen displays to indicate that the SSL VPN connection is about to terminate.

Figure 271 Logout: Connection Termination Progress

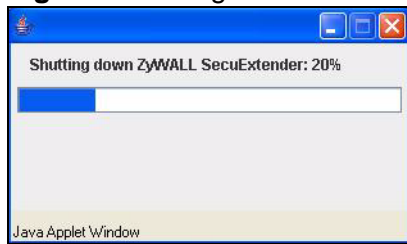

SSL User Application Screens

26.1 SSL User Application Screens Overview

Use the **Application** screen to access web-based applications (such as web sites and e-mail) on the network through the SSL VPN connection. Which applications you can access depends on the ZyWALL's configuration.

26.2 The Application Screen

Click the **Application** tab to display the screen. The **Name** field displays the descriptive name for an application. The **Type** field displays whether the application supports Virtual Network Computing (VNC) or Remote Desktop Protocol (RDP).

To access a web-based application, simply click a link in the **Application** screen to display the web screen in a separate browser window.

Figure 272 Application

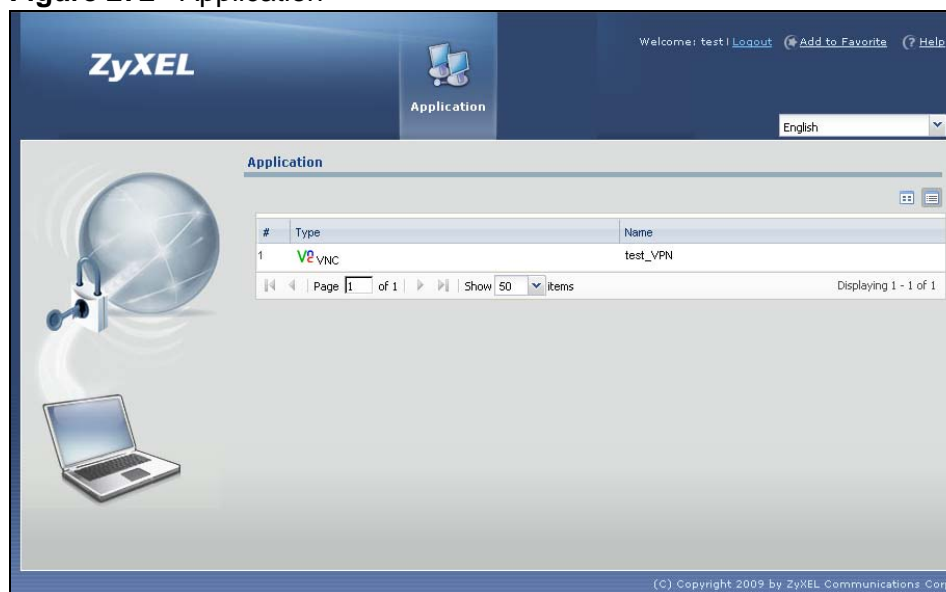

ZyWALL SecuExtender

The ZyWALL automatically loads the ZyWALL SecuExtender client program to your computer after a successful login. The ZyWALL SecuExtender lets you:

- Access servers, remote desktops and manage files as if you were on the local network.
- Use applications like e-mail, file transfer, and remote desktop programs directly without using a browser. For example, you can use Outlook for e-mail instead of the ZyWALL's web-based e-mail.
- Use applications, even proprietary applications, for which the ZyWALL does not offer SSL application objects.

The applications must be installed on your computer. For example, to use the VNC remote desktop program, you must have the VNC client installed on your computer.

27.1 The ZyWALL SecuExtender Icon

The ZyWALL SecuExtender icon color indicates the SSL VPN tunnel's connection status.

Figure 273 ZyWALL SecuExtender Icon



- Red: the SSL VPN tunnel is not connected. You cannot connect to the SSL application and network resources.
- Green: the SSL VPN tunnel is connected. You can connect to the SSL application and network resources. You can also use another application to access resources behind the ZyWALL.
- Gray: the SSL VPN tunnel's connection is suspended. This means the SSL VPN tunnel is connected, but the ZyWALL SecuExtender will not send any traffic through it until you right-click the icon and resume the connection.

27.2 Statistics

Right-click the ZyWALL SecuExtender icon in the system tray and select **Status** to open the **Status** screen. Use this screen to view the ZyWALL SecuExtender's statistics.

Figure 274 ZyWALL SecuExtender Status

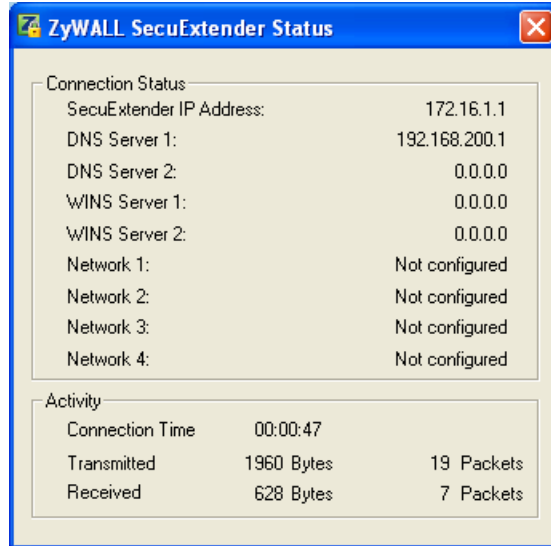

The following table describes the labels in this screen.

Table 126 ZyWALL SecuExtender Statistics

LABEL	DESCRIPTION
Connection Status	
SecuExtender IP Address	This is the IP address the ZyWALL assigned to this remote user computer for an SSL VPN connection.
DNS Server 1/2	These are the IP addresses of the DNS server and backup DNS server for the SSL VPN connection. DNS (Domain Name System) maps a domain name to its corresponding IP address and vice versa. The DNS server is extremely important because without it, you must know the IP address of a computer before you can access it. Your computer uses the DNS server specified here to resolve domain names for resources you access through the SSL VPN connection.
WINS Server 1/2	These are the IP addresses of the WINS (Windows Internet Naming Service) and backup WINS servers for the SSL VPN connection. The WINS server keeps a mapping table of the computer names on your network and the IP addresses that they are currently using.
Network 1~4	These are the networks (including netmask) that you can access through the SSL VPN connection.
Activity	
Connected Time	This is how long the computer has been connected to the SSL VPN tunnel.

Table 126 ZyWALL SecuExtender Statistics

LABEL	DESCRIPTION
Transmitted	This is how many bytes and packets the computer has sent through the SSL VPN connection.
Received	This is how many bytes and packets the computer has received through the SSL VPN connection.

27.3 View Log

If you have problems with the ZyWALL SecuExtender, customer support may request you to provide information from the log. Right-click the ZyWALL SecuExtender icon in the system tray and select **Log** to open a notepad file of the ZyWALL SecuExtender's log.

Figure 275 ZyWALL SecuExtender Log Example

```
#####
#####
[ 2009/03/12 13:35:50 ][SecuExtender Agent][DETAIL] Build Datetime: Feb 24
2009/10:25:07
[ 2009/03/12 13:35:50 ][SecuExtender Agent][DEBUG] rasphone.pbk:
C:\Documents and Settings\11746\rasphone.pbk
[ 2009/03/12 13:35:50 ][SecuExtender Agent][DEBUG] SecuExtender.log:
C:\Documents and Settings\11746\SecuExtender.log
[ 2009/03/12 13:35:50 ][SecuExtender Agent][DETAIL] Check Parameters
[ 2009/03/12 13:35:50 ][SecuExtender Agent][DETAIL] Connect to
172.23.31.19:443/10444
[ 2009/03/12 13:35:50 ][SecuExtender Agent][DETAIL] Parameter is OK
[ 2009/03/12 13:35:50 ][SecuExtender Agent][DETAIL] Checking System
status...
[ 2009/03/12 13:35:50 ][SecuExtender Agent][DETAIL] Checking service
(first) ...
[ 2009/03/12 13:35:50 ][SecuExtender Agent][DETAIL] SecuExtender Helper is
running
[ 2009/03/12 13:35:50 ][SecuExtender Agent][DETAIL] System is OK
[ 2009/03/12 13:35:50 ][SecuExtender Agent][DEBUG] Connect to 2887196435/
443
[ 2009/03/12 13:35:50 ][SecuExtender Agent][DETAIL] Handshake LoopCounter:
0
[ 2009/03/12 13:35:50 ][SecuExtender Agent][DETAIL] 611 bytes of handshake
data received
```

27.4 Suspend and Resume the Connection

When the ZyWALL SecuExtender icon in the system tray is green, you can right-click the icon and select **Suspend Connection** to keep the SSL VPN tunnel

connected but not send any traffic through it until you right-click the icon and resume the connection.

27.5 Stop the Connection

Right-click the icon and select **Stop Connection** to disconnect the SSL VPN tunnel.

27.6 Uninstalling the ZyWALL SecuExtender

Do the following if you need to remove the ZyWALL SecuExtender.

- 1 Click **start > All Programs > ZyXEL > ZyWALL SecuExtender > Uninstall**.
- 2 In the confirmation screen, click **Yes**.

Figure 276 Uninstalling the ZyWALL SecuExtender Confirmation

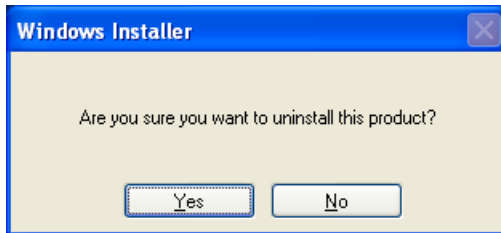

- 3 Windows uninstalls the ZyWALL SecuExtender.

Figure 277 ZyWALL SecuExtender Uninstallation

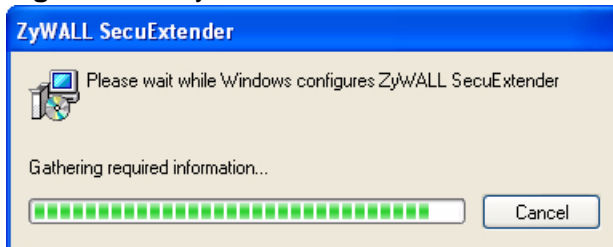

Bandwidth Management

28.1 Overview

Bandwidth management provides a convenient way to manage the use of various services on the network. It manages general protocols (for example, HTTP and FTP) and applies traffic prioritization to enhance the performance of delay-sensitive applications like voice and video.

28.1.1 What You Can Do in this Chapter

Use the **BWM** screens (see [Section 28.2 on page 461](#)) to control bandwidth for services passing through the ZyWALL, and it identifies the conditions that refine this.

28.1.2 What You Need to Know

When you allow a service, you can restrict the bandwidth it uses. It controls TCP and UDP traffic. Use policy routes to manage other types of traffic (like ICMP).

Note: Bandwidth management in policy routes has priority over policy routes to manage the bandwidth of TCP and UDP traffic.

If you want to use a service, make sure both the firewall allow the service's packets to go through the ZyWALL.

Note: The ZyWALL checks firewall rules before it checks bandwidth management rules for traffic going through the ZyWALL.

Bandwidth management examines every TCP and UDP connection passing through the ZyWALL. Then, you can specify, by port, whether or not the ZyWALL continues to route the connection.

DiffServ and DSCP Marking

QoS is used to prioritize source-to-destination traffic flows. All packets in the same flow are given the same priority. CoS (class of service) is a way of managing traffic

in a network by grouping similar types of traffic together and treating each type as a class. You can use CoS to give different priorities to different packet types.

DiffServ (Differentiated Services) is a class of service (CoS) model that marks packets so that they receive specific per-hop treatment at DiffServ-compliant network devices along the route based on the application types and traffic flow. Packets are marked with DiffServ Code Points (DSCPs) indicating the level of service desired. This allows the intermediary DiffServ-compliant network devices to handle the packets differently depending on the code points without the need to negotiate paths or remember state information for every flow. In addition, applications do not have to request a particular service or give advanced notice of where the traffic is going.

Connection and Packet Directions

Bandwidth management looks at the connection direction, that is from which zone the connection was initiated and to which zone the connection is going.

A connection has outbound and inbound packet flows. The ZyWALL controls the bandwidth of traffic of each flow as it is going out through an interface or VPN tunnel.

- The outbound traffic flows from the connection initiator to the connection responder.
- The inbound traffic flows from the connection responder to the connection initiator.

For example, a LAN1 to WAN connection is initiated from LAN1 and goes to the WAN.

- Outbound traffic goes from a LAN1 zone device to a WAN zone device. Bandwidth management is applied before sending the packets out a WAN zone interface on the ZyWALL.
- Inbound traffic comes back from the WAN zone device to the LAN1 zone device. Bandwidth management is applied before sending the traffic out a LAN1 zone interface.

Figure 278 LAN1 to WAN Connection and Packet Directions

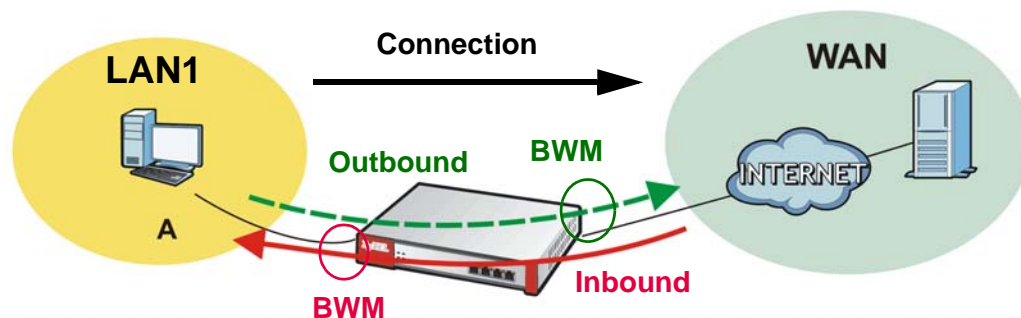

Outbound and Inbound Bandwidth Limits

You can limit an application's outbound or inbound bandwidth. This limit keeps the traffic from using up too much of the out-going interface's bandwidth. This way you can make sure there is bandwidth for other applications. When you apply a bandwidth limit to outbound or inbound traffic, each member of the out-going zone can send up to the limit. Take a LAN1 to WAN policy for example.

- Outbound traffic is limited to 200 kbps. The connection initiator is on the LAN1 so outbound means the traffic traveling from the LAN1 to the WAN. Each of the WAN zone's two interfaces can send the limit of 200 kbps of traffic.
- Inbound traffic is limited to 500 kbs. The connection initiator is on the LAN1 so inbound means the traffic traveling from the WAN to the LAN1.

Figure 279 LAN1 to WAN, Outbound 200 kbps, Inbound 500 kbps

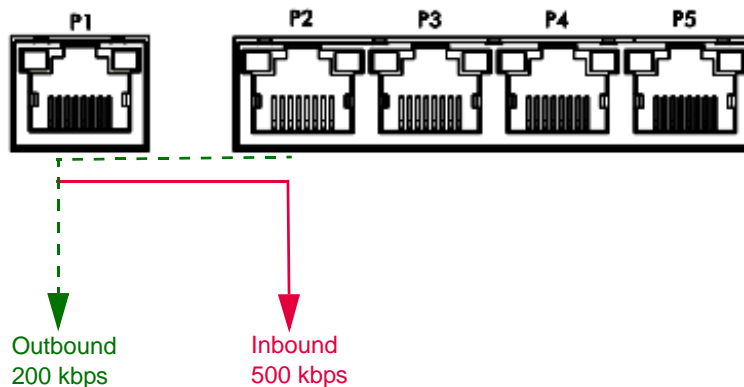

Bandwidth Management Priority

- The ZyWALL gives bandwidth to higher-priority traffic first, until it reaches its configured bandwidth rate.
- Then lower-priority traffic gets bandwidth.
- The ZyWALL uses a fairness-based (round-robin) scheduler to divide bandwidth among traffic flows with the same priority.
- The ZyWALL automatically treats traffic with bandwidth management disabled as priority 7 (the lowest priority).

Maximize Bandwidth Usage

Maximize bandwidth usage allows applications with maximize bandwidth usage enabled to "borrow" any unused bandwidth on the out-going interface.

After each application gets its configured bandwidth rate, the ZyWALL uses the fairness-based scheduler to divide any unused bandwidth on the out-going interface amongst applications that need more bandwidth and have maximize bandwidth usage enabled.

Unused bandwidth is divided equally. Higher priority traffic does not get a larger portion of the unused bandwidth.

Bandwidth Management Behavior

The following sections show how bandwidth management behaves with various settings. For example, you configure DMZ to WAN policies for FTP servers **A** and **B**. Each server tries to send 1000 kbps, but the WAN is set to a maximum outgoing speed of 1000 kbps. You configure policy A for server **A**'s traffic and policy B for server **B**'s traffic.

Figure 280 Bandwidth Management Behavior

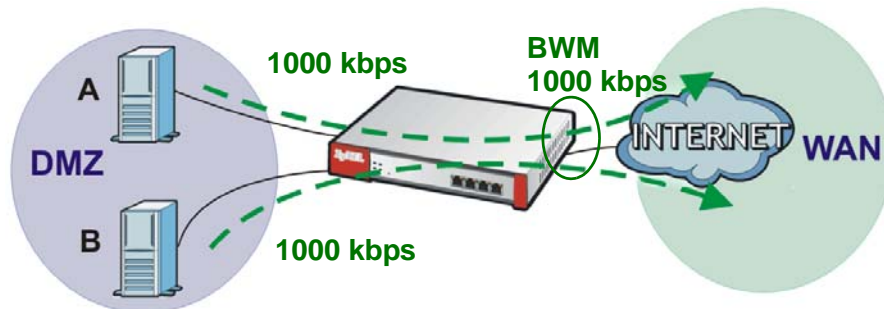

Configured Rate Effect

In the following table the configured rates total less than the available bandwidth and maximize bandwidth usage is disabled, both servers get their configured rate.

Table 127 Configured Rate Effect

POLICY	CONFIGURED RATE	MAX. B. U.	PRIORITY	ACTUAL RATE
A	300 kbps	No	1	300 kbps
B	200 kbps	No	1	200 kbps

Priority Effect

Here the configured rates total more than the available bandwidth. Because server **A** has higher priority, it gets up to its configured rate (800 kbps), leaving only 200 kbps for server **B**.

Table 128 Priority Effect

POLICY	CONFIGURED RATE	MAX. B. U.	PRIORITY	ACTUAL RATE
A	800 kbps	Yes	1	800 kbps
B	1000 kbps	Yes	2	200 kbps

Maximize Bandwidth Usage Effect

With maximize bandwidth usage enabled, after each server gets its configured rate, the rest of the available bandwidth is divided equally between the two. So server **A** gets its configured rate of 300 kbps and server **B** gets its configured rate of 200 kbps. Then the ZyWALL divides the remaining bandwidth ($1000 - 500 = 500$) equally between the two ($500 / 2 = 250$ kbps for each). The priority has no effect on how much of the unused bandwidth each server gets.

So server **A** gets its configured rate of 300 kbps plus 250 kbps for a total of 550 kbps. Server **B** gets its configured rate of 200 kbps plus 250 kbps for a total of 450 kbps.

Table 129 Maximize Bandwidth Usage Effect

POLICY	CONFIGURED RATE	MAX. B. U.	PRIORITY	ACTUAL RATE
A	300 kbps	Yes	1	550 kbps
B	200 kbps	Yes	2	450 kbps

Priority and Over Allotment of Bandwidth Effect

Server **A** has a configured rate that equals the total amount of available bandwidth and a higher priority. You should regard extreme over allotment of traffic with different priorities (as shown here) as a configuration error. Even though the ZyWALL still attempts to let all traffic get through and not be lost, regardless of its priority, server **B** gets almost no bandwidth with this configuration.

Table 130 Priority and Over Allotment of Bandwidth Effect

POLICY	CONFIGURED RATE	MAX. B. U.	PRIORITY	ACTUAL RATE
A	1000 kbps	Yes	1	999 kbps
B	1000 kbps	Yes	2	1 kbps

Finding Out More

- See [Section 7.5 on page 120](#) for an example of how to set up web surfing policies with bandwidth restrictions.
- See [DSCP Marking and Per-Hop Behavior on page 299](#) for a description of DSCP marking.

28.1.3 Bandwidth Management Examples

Bandwidth management is very useful when applications are competing for limited bandwidth. For example, say you have a WAN zone interface connected to an ADSL device with a 8 Mbps downstream and 1 Mbps upstream ADSL connection.

Here is an overview of what the rules need to accomplish. See the following sections for more details.

- SIP traffic from VIP users must get through with the least possible delay regardless of if it is an outgoing call or an incoming call. The VIP users must be able to make and receive SIP calls no matter which interface they are connected to.
- HTTP traffic needs to be given priority over FTP traffic.
- FTP traffic from the WAN to the DMZ must be limited so it does not interfere with SIP and HTTP traffic.
- FTP traffic from the LAN1 to the DMZ can use more bandwidth since the interfaces support up to 1 Gbps connections, but it must be the lowest priority and limited so it does not interfere with SIP and HTTP traffic.

Figure 281 Bandwidth Management Example

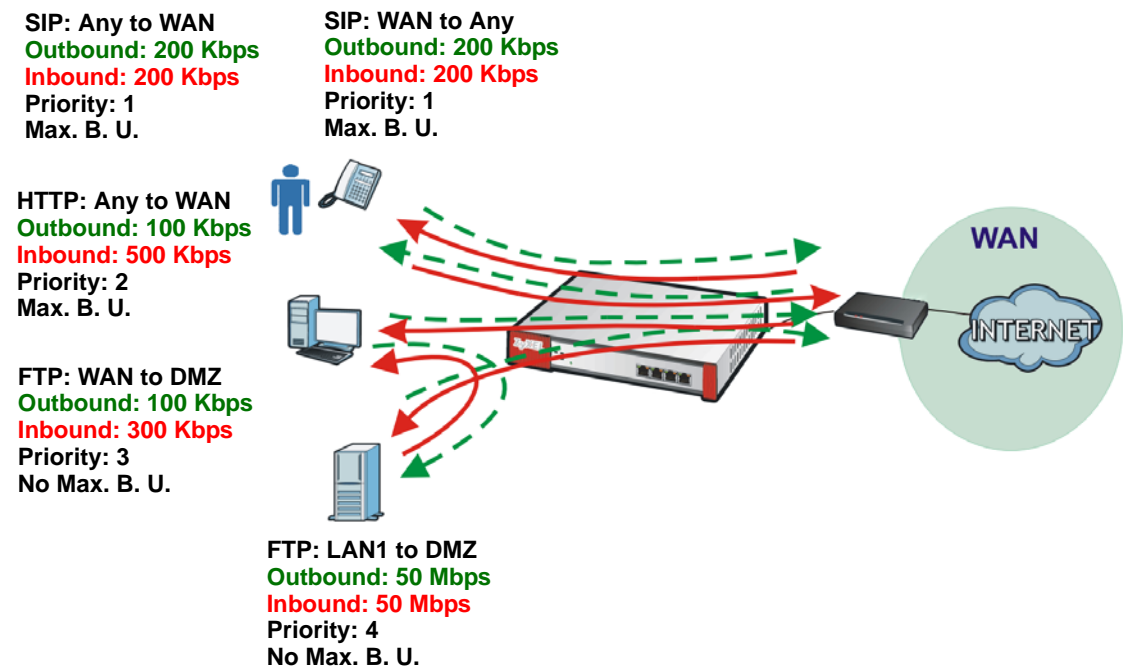

28.1.3.1 Setting the Interface's Bandwidth

Use the interface screens to set the WAN zone interface's upstream bandwidth to be equal to (or slightly less than) what the connected device can support. This example uses 1000 Kbps.

28.1.3.2 SIP Any to WAN Bandwidth Management Example

- Manage SIP traffic going to the WAN zone from a VIP user on the LAN or DMZ.
- Outbound traffic (to the WAN from the LAN and DMZ) is limited to 200 kbps. The ZyWALL applies this limit before sending the traffic to the WAN.
- Inbound traffic (to the LAN and DMZ from the WAN) is also limited to 200 kbps. The ZyWALL applies this limit before sending the traffic to LAN or DMZ.

- Enable maximize bandwidth usage so the SIP traffic can borrow unused bandwidth.

Figure 282 SIP Any to WAN Bandwidth Management Example

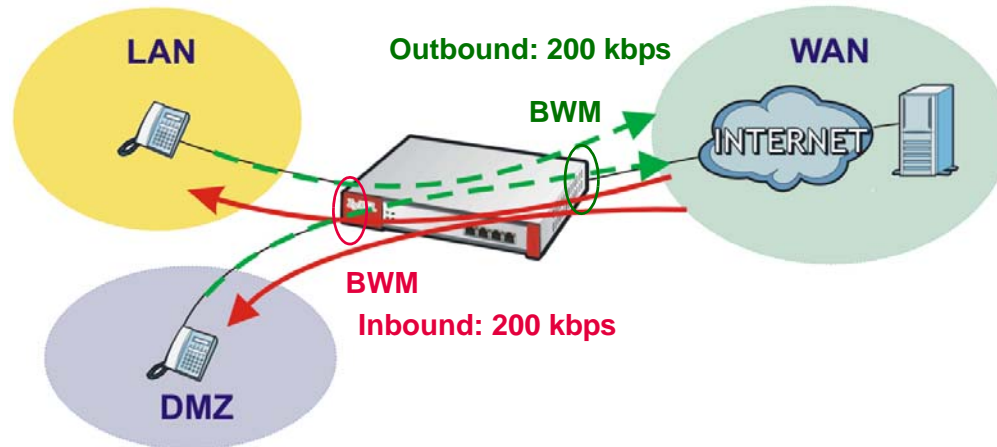

28.1.3.3 SIP WAN to Any Bandwidth Management Example

You also create a policy for calls coming in from the SIP server on the WAN. It is the same as the SIP Any to WAN policy, but with the directions reversed (WAN to Any instead of Any to WAN).

28.1.3.4 HTTP Any to WAN Bandwidth Management Example

- Inbound traffic gets more bandwidth as the local users will probably download more than they upload (and the ADSL connection supports this).
- Second highest priority (2). Set policies for other applications (except SIP) to lower priorities so the local users' HTTP traffic gets sent before non-SIP traffic.
- Enable maximize bandwidth usage so the HTTP traffic can borrow unused bandwidth.

Figure 283 HTTP Any to WAN Bandwidth Management Example

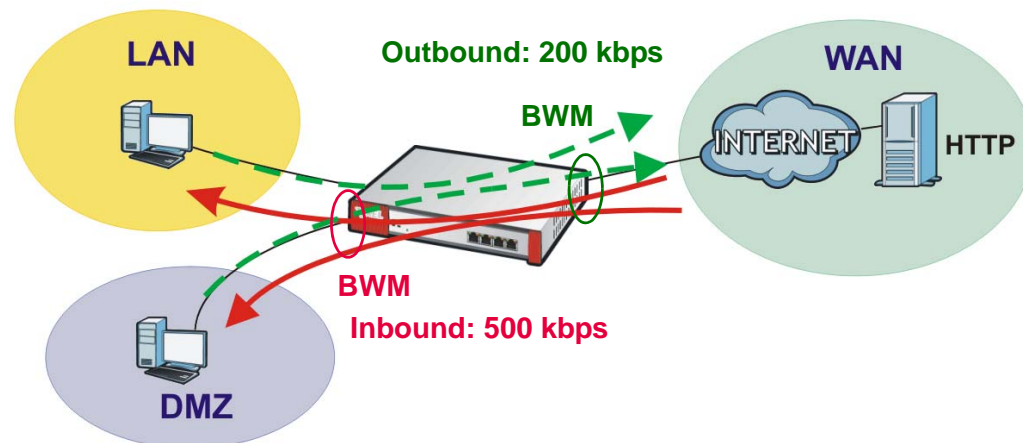

28.1.3.5 FTP WAN to DMZ Bandwidth Management Example

- ADSL supports more downstream than upstream so you allow remote users 300 kbps for uploads to the DMZ FTP server (outbound) but only 100 kbps for downloads (inbound).
- Third highest priority (3).
- Disable maximize bandwidth usage since you do not want to give FTP more bandwidth.

Figure 284 FTP WAN to DMZ Bandwidth Management Example

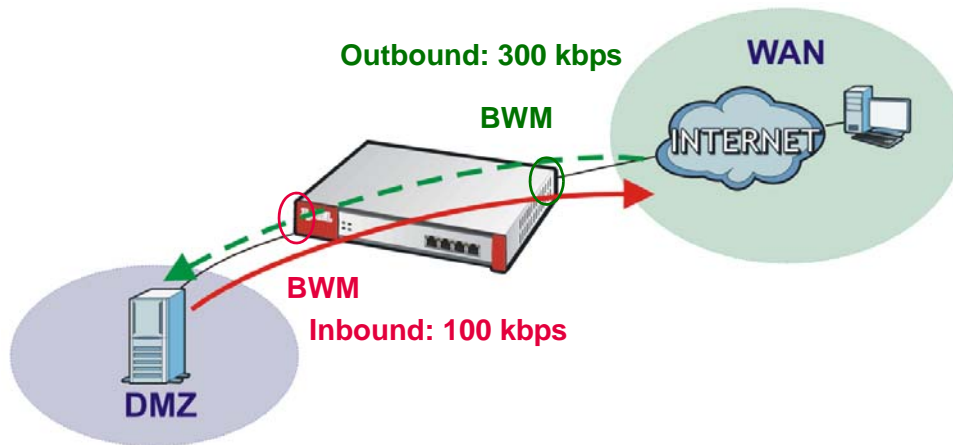

28.1.3.6 FTP LAN to DMZ Bandwidth Management Example

- The LAN and DMZ zone interfaces are connected to Ethernet networks (not an ADSL device) so you limit both outbound and inbound traffic to 50 Mbps.
- Fourth highest priority (4).
- Disable maximize bandwidth usage since you do not want to give FTP more bandwidth.

Figure 285 FTP LAN to DMZ Bandwidth Management Example

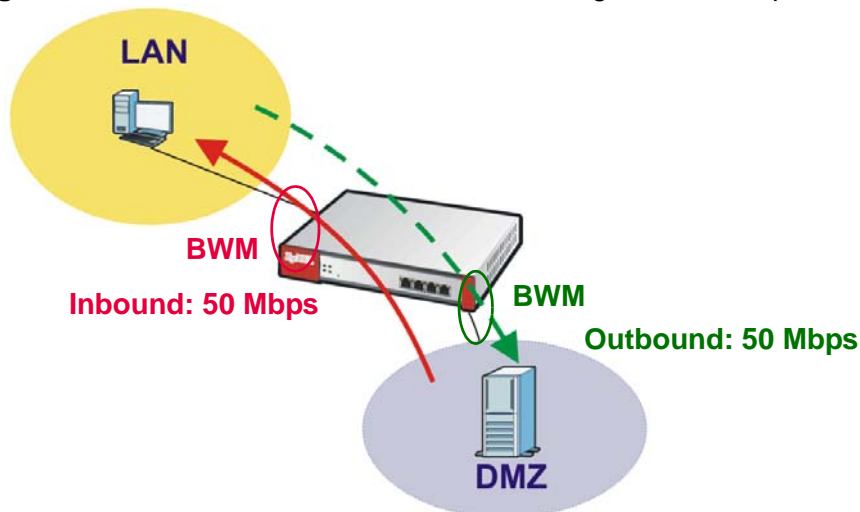

28.2 The Bandwidth Management Screen

The Bandwidth management screen controls the default policy for TCP and UDP traffic. You can use source zone, destination zone, destination port, schedule, user, source, and destination information as criteria to create a sequence of specific conditions, similar to the sequence of rules used by firewalls, to specify what the ZyWALL should do more precisely. This screen also allows you to add, edit, and remove conditions to this default policy.

Click **Configuration > Bandwidth Management** to open the following screen.

Figure 286 Configuration > Bandwidth Management

The following table describes the labels in this screen. See [Section 28.2.1 on page 463](#) for more information as well.

Table 131 Configuration > Bandwidth Management

LABEL	DESCRIPTION
Enable BWM	Select this check box to activate management bandwidth.
Add	Click this to create a new entry. Select an entry and click Add to create a new entry after the selected entry.
Edit	Select an entry and click this to be able to modify it.
Remove	Select an entry and click this to delete it.
Activate	To turn on an entry, select it and click Activate .
Inactivate	To turn off an entry, select it and click Inactivate .
Move	To change an entry's position in the numbered list, select it and click Move to display a field to type a number for where you want to put that entry and press [ENTER] to move the entry to the number that you typed.
Status	The activate (light bulb) icon is lit when the entry is active and dimmed when the entry is inactive.

Table 131 Configuration > Bandwidth Management

LABEL	DESCRIPTION
#	<p>This field is a sequential value, and it is not associated with a specific condition.</p> <p>Note: The ZyWALL checks conditions in the order they appear in the list. While this sequence does not affect the functionality, you might improve the performance of the ZyWALL by putting more common conditions at the top of the list.</p>
Destination Port	This field displays the specific port number to which this policy applies.
Schedule	This is the schedule that defines when the policy applies. any means the policy always applies.
User	This is the user name or user group to which the policy applies. If any displays, the policy applies to all users.
From	This is the source zone of the traffic to which this policy applies.
To	This is the destination zone of the traffic to which this policy applies.
Source	This is the source address or address group for whom this policy applies. If any displays, the policy is effective for every source.
Destination	This is the destination address or address group for whom this policy applies. If any displays, the policy is effective for every destination.
DSCP Marking	<p>This is how the ZyWALL handles the DSCP value of the outgoing packets that match this policy.</p> <p>In - Inbound, the traffic the ZyWALL sends to a connection's initiator.</p> <p>Out - Outbound, the traffic the ZyWALL sends out from a connection's initiator.</p> <p>If this field displays a DSCP value, the ZyWALL applies that DSCP value to the route's outgoing packets.</p> <p>preserve means the ZyWALL does not modify the DSCP value of the route's outgoing packets.</p> <p>default means the ZyWALL sets the DSCP value of the route's outgoing packets to 0.</p> <p>The "af" choices stand for Assured Forwarding. The number following the "af" identifies one of four classes and one of three drop preferences. See Assured Forwarding (AF) PHB for DiffServ on page 309 for more details.</p>

Table 131 Configuration > Bandwidth Management

LABEL	DESCRIPTION
BWM	<p>These fields show the amount of bandwidth the traffic can use.</p> <p>In - This is how much inbound bandwidth, in kilobits per second, this policy allows the matching traffic to use. Inbound refers to the traffic the ZyWALL sends to a connection's initiator. If no displays here, this policy does not apply bandwidth management for the inbound traffic.</p> <p>Out - This is how much outgoing bandwidth, in kilobits per second, this policy allows the matching traffic to use. Outbound refers to the traffic the ZyWALL sends out from a connection's initiator. If no displays here, this policy does not apply bandwidth management for the outbound traffic.</p> <p>Pri - This is the priority for the traffic that matches this policy. The smaller the number, the higher the priority. Traffic with a higher priority is given bandwidth before traffic with a lower priority. The ZyWALL ignores this number if the incoming and outgoing limits are both set to 0. In this case the traffic is automatically treated as being set to the lowest priority (7) regardless of this field's configuration.</p>
Apply	Click Apply to save your changes back to the ZyWALL.
Reset	Click Reset to return the screen to its last-saved settings.

28.2.1 The Bandwidth Management Add/Edit Screen

The **Configuration > Bandwidth Management Add/Edit** screen allows you to create a new condition or edit an existing one. To access this screen, go to the **Configuration > Bandwidth Management** screen (see [Section 28.2 on page 461](#)), and click either the **Add** icon or an **Edit** icon.

Figure 287 Configuration > Bandwidth Management > Edit

The following table describes the labels in this screen.

Table 132 Configuration > Bandwidth Management

LABEL	DESCRIPTION
Create new Object	Use to configure any new settings objects that you need to use in this screen.
Enable	Select this check box to turn on this policy.
Destination Port	Use this field to specify a specific port number to which to apply this policy. Type zero, if this policy applies for every port number.
Schedule	Select a schedule that defines when the policy applies or select Create Object to configure a new one (see Chapter 36 on page 567 for details). Otherwise, select any to make the policy always effective.
User	Select a user name or user group to which to apply the policy. Use Create new Object if you need to configure a new user account (see Section 33.2.1 on page 542 for details). Select any to apply the policy for every user.
From	Select the source zone of the traffic to which this policy applies.
To	Select the destination zone of the traffic to which this policy applies.
Source	Select a source address or address group for whom this policy applies. Use Create new Object if you need to configure a new one. Select any if the policy is effective for every source.
Destination	Select a destination address or address group for whom this policy applies. Use Create new Object if you need to configure a new one. Select any if the policy is effective for every destination.
Protocol	Select the protocol for which this condition applies. Choices are: TCP and UDP . Select any to apply the policy to both TCP and UDP traffic.
DSCP Marking	<p>Set how the ZyWALL handles the DSCP value of the outgoing packets that match this policy. Inbound refers to the traffic the ZyWALL sends to a connection's initiator. Outbound refers to the traffic the ZyWALL sends out from a connection's initiator.</p> <p>Select one of the pre-defined DSCP values to apply or select User Defined to specify another DSCP value. The "af" choices stand for Assured Forwarding. The number following the "af" identifies one of four classes and one of three drop preferences. See Assured Forwarding (AF) PHB for DiffServ on page 309 for more details.</p> <p>Select preserve to have the ZyWALL keep the packets' original DSCP value.</p> <p>Select default to have the ZyWALL set the DSCP value of the packets to 0.</p>
Bandwidth Management	Configure these fields to set the amount of bandwidth the application can use.

Table 132 Configuration > Bandwidth Management

LABEL	DESCRIPTION
Inbound kbps	<p>Type how much inbound bandwidth, in kilobits per second, this policy allows the traffic to use. Inbound refers to the traffic the ZyWALL sends to a connection's initiator.</p> <p>If you enter 0 here, this policy does not apply bandwidth management for the matching traffic that the ZyWALL sends to the initiator. Traffic with bandwidth management disabled (inbound and outbound are both set to 0) is automatically treated as the lowest priority (7).</p> <p>If the sum of the bandwidths for routes using the same next hop is higher than the actual transmission speed, lower priority traffic may not be sent if higher priority traffic uses all of the actual bandwidth.</p>
Outbound kbps	<p>Type how much outbound bandwidth, in kilobits per second, this policy allows the traffic to use. Outbound refers to the traffic the ZyWALL sends out from a connection's initiator.</p> <p>If you enter 0 here, this policy does not apply bandwidth management for the matching traffic that the ZyWALL sends out from the initiator. Traffic with bandwidth management disabled (inbound and outbound are both set to 0) is automatically treated as the lowest priority (7).</p> <p>If the sum of the bandwidths for routes using the same next hop is higher than the actual transmission speed, lower priority traffic may not be sent if higher priority traffic uses all of the actual bandwidth.</p>
Priority	<p>This field displays when the inbound or outbound bandwidth management is not set to 0. Enter a number between 1 and 7 to set the priority for traffic that matches this policy. The smaller the number, the higher the priority.</p> <p>Traffic with a higher priority is given bandwidth before traffic with a lower priority.</p> <p>The ZyWALL uses a fairness-based (round-robin) scheduler to divide bandwidth between traffic flows with the same priority.</p> <p>The number in this field is ignored if the incoming and outgoing limits are both set to 0. In this case the traffic is automatically treated as being set to the lowest priority (7) regardless of this field's configuration.</p>
Maximize Bandwidth Usage	<p>This field displays when the inbound or outbound bandwidth management is not set to 0. Enable maximize bandwidth usage to let the traffic matching this policy "borrow" any unused bandwidth on the out-going interface.</p> <p>After each application or type of traffic gets its configured bandwidth rate, the ZyWALL uses the fairness-based scheduler to divide any unused bandwidth on the out-going interface amongst applications and traffic types that need more bandwidth and have maximize bandwidth usage enabled.</p>
OK	Click OK to save your changes back to the ZyWALL.
Cancel	Click Cancel to exit this screen without saving your changes.

29.1 Overview

This chapter introduces ADP (Anomaly Detection and Prevention), anomaly profiles and applying an ADP profile to a traffic direction. ADP protects against anomalies based on violations of protocol standards (RFCs – Requests for Comments) and abnormal flows such as port scans.

29.1.1 ADP

- 1 ADP anomaly detection is in general effective against abnormal behavior.
- 2 ADP traffic and anomaly rules are updated when you upload new firmware.

29.1.2 What You Can Do in this Chapter

- Use **Anti-X > ADP > General** ([Section 29.2 on page 469](#)) to turn anomaly detection on or off and apply anomaly profiles to traffic directions.
- Use **Anti-X > ADP > Profile** ([Section 29.3 on page 470](#)) to add a new profile, edit an existing profile or delete an existing profile.

29.1.3 What You Need To Know

Traffic Anomalies

Traffic anomaly rules look for abnormal behavior or events such as port scanning, sweeping or network flooding. It operates at OSI layer-2 and layer-3. Traffic anomaly rules may be updated when you upload new firmware.

Protocol Anomalies

Protocol anomalies are packets that do not comply with the relevant RFC (Request For Comments). Protocol anomaly detection includes HTTP Inspection, TCP Decoder, UDP Decoder and ICMP Decoder. Protocol anomaly rules may be updated when you upload new firmware.

ADP Profile

An ADP profile is a set of traffic anomaly rules and protocol anomaly rules that you can activate as a set and configure common bg and action settings. You can apply ADP profiles to traffic flowing from one zone to another.

Base ADP Profiles

Base ADP profiles are templates that you use to create new ADP profiles. The ZyWALL comes with several base profiles. See [Table 134 on page 471](#) for details on ADP base profiles.

ADP Policy

An ADP policy refers to application of an ADP profile to a traffic flow.

Finding Out More

- See [Section 6.5.17 on page 102](#) for ADP prerequisites.
- See [Section 29.4 on page 479](#) for background information on these screens.

29.1.4 Before You Begin

Configure the ZyWALL's zones - see [Chapter 15 on page 327](#) for more information.

29.2 The ADP General Screen

Click **Configuration > Anti-X > ADP > General**. Use this screen to turn anomaly detection on or off and apply anomaly profiles to traffic directions.

Figure 288 Configuration > Anti-X > ADP > General

#	Priority	Status	From	To	Anomaly Profile
1	1	⚡	any	LAN1	ADP_PROFILE
2	2	⚡	any	LAN2	ADP_PROFILE
3	3	⚡	any	VLAN	ADP_PROFILE
4	4	⚡	any	DMZ	ADP_PROFILE
5	5	⚡	any	ZyWALL	ADP_PROFILE

The following table describes the screens in this screen.

Table 133 Configuration > Anti-X > ADP > General

LABEL	DESCRIPTION
General Settings	
Enable Anomaly Detection	Select this check box to enable traffic anomaly and protocol anomaly detection.
Policies	Use this list to specify which anomaly profile the ZyWALL uses for traffic flowing in a specific direction. Edit the policies directly in the table.
Add	Click this to create a new entry. Select an entry and click Add to create a new entry after the selected entry.
Edit	Select an entry and click this to be able to modify it.
Remove	Select an entry and click this to delete it.
Activate	To turn on an entry, select it and click Activate .
Inactivate	To turn off an entry, select it and click Inactivate .
Move	To change an entry's position in the numbered list, select it and click Move to display a field to type a number for where you want to put that entry and press [ENTER] to move the entry to the number that you typed.
#	This is the entry's index number in the list.
Priority	This is the rank in the list of anomaly profile policies. The list is applied in order of priority.

Table 133 Configuration > Anti-X > ADP > General (continued)

LABEL	DESCRIPTION
Status	The activate (light bulb) icon is lit when the entry is active and dimmed when the entry is inactive.
From, To	<p>This is the direction of travel of packets to which an anomaly profile is bound. Traffic direction is defined by the zone the traffic is coming from and the zone the traffic is going to.</p> <p>Use the From field to specify the zone from which the traffic is coming. Select ZyWALL to specify traffic coming from the ZyWALL itself.</p> <p>Use the To field to specify the zone to which the traffic is going. Select ZyWALL to specify traffic destined for the ZyWALL itself.</p> <p>From LAN1 To LAN1 means packets traveling from a computer on one LAN1 subnet to a computer on another LAN1 subnet via the ZyWALL's LAN1 zone interfaces. The ZyWALL does not check packets traveling from a LAN1 computer to another LAN1 computer on the same subnet.</p> <p>From WAN To WAN means packets that come in from the WAN zone and the ZyWALL routes back out through the WAN zone.</p> <p>Note: Depending on your network topology and traffic load, applying every packet direction to an anomaly profile may affect the ZyWALL's performance.</p>
Anomaly Profile	An anomaly profile is a set of anomaly rules with configured activation, log and action settings. This field shows which anomaly profile is bound to which traffic direction. Select an ADP profile to apply to the entry's traffic direction. Configure the ADP profiles in the ADP profile screens.
Apply	Click Apply to save your changes.
Reset	Click Reset to return the screen to its last-saved settings.

29.3 The Profile Summary Screen

Use this screen to:

- Create a new profile using an existing base profile
- Edit an existing profile
- Delete an existing profile

29.3.1 Base Profiles

The ZyWALL comes with base profiles. You use base profiles to create new profiles. In the **Configuration > Anti-X > ADP > Profile** screen, click **Add** to display the following screen.

Figure 289 Base Profiles

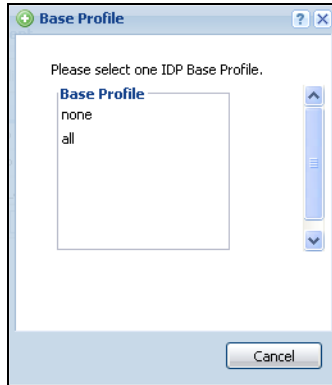

These are the default base profiles at the time of writing.

Table 134 Base Profiles

BASE PROFILE	DESCRIPTION
none	All traffic anomaly and protocol anomaly rules are disabled. No logs are generated nor actions are taken.
all	All traffic anomaly and protocol anomaly rules are enabled. Rules with a high or severe severity level (greater than three) generate log alerts and cause packets that trigger them to be dropped. Rules with a very low, low or medium severity level (less than or equal to three) generate logs (not log alerts) and no action is taken on packets that trigger them.
OK	Click OK to save your changes.
Cancel	Click Cancel to exit this screen without saving your changes.

29.3.2 Configuring The ADP Profile Summary Screen

Select **Configuration > Anti-X > ADP > Profile**.

Figure 290 Configuration > Anti-X > ADP > Profile

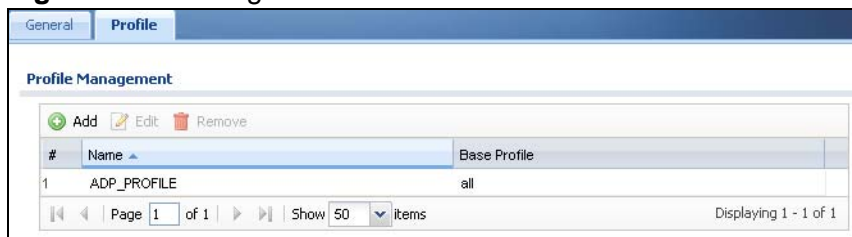

The following table describes the fields in this screen.

Table 135 Anti-X > ADP > Profile

LABEL	DESCRIPTION
Add	Click this to create a new entry.
Edit	Select an entry and click this to be able to modify it.
Remove	Select an entry and click this to delete it.
#	This is the entry's index number in the list.
Name	This is the name of the profile you created.
Base Profile	This is the base profile from which the profile was created.

29.3.3 Creating New ADP Profiles

You may want to create a new profile if not all rules in a base profile are applicable to your network. In this case you should disable non-applicable rules so as to improve ZyWALL ADP processing efficiency.

You may also find that certain rules are triggering too many false positives or false negatives. A false positive is when valid traffic is flagged as an attack. A false negative is when invalid traffic is wrongly allowed to pass through the ZyWALL. As each network is different, false positives and false negatives are common on initial ADP deployment.

You could create a new 'monitor profile' that creates logs but all actions are disabled. Observe the logs over time and try to eliminate the causes of the false alarms. When you're satisfied that they have been reduced to an acceptable level, you could then create an 'inline profile' whereby you configure appropriate actions to be taken when a packet matches a rule.

ADP profiles consist of traffic anomaly profiles and protocol anomaly profiles. To create a new profile, select a base profile (see [Table 134 on page 471](#)) and then click **OK** to go to the profile details screen. Type a new profile name, enable or disable individual rules and then edit the default log options and actions.

29.3.4 Traffic Anomaly Profiles

The traffic anomaly screen is the second screen in an ADP profile. Traffic anomaly detection looks for abnormal behavior such as scan or flooding attempts. In the **Configuration > Anti-X > ADP > Profile** screen, click the **Edit** icon or click the **Add** icon and choose a base profile. If you made changes to other screens

belonging to this profile, make sure you have clicked **OK** or **Save** to save the changes before selecting the **Traffic Anomaly** tab.

Figure 291 Profiles: Traffic Anomaly

Traffic Anomaly | Protocol Anomaly

General

Name:

Scan Detection

Sensitivity: (v)

Block Period: (1-3600 seconds)

⚡ Activate | ⚪ Inactivate | 📄 Log | ⚙️ Action

#	Status	Name	Log	Action
1	⚪	(open port) Open Port	no	none
2	⚪	(portscan) IP Decoy Protocol Scan	no	none
3	⚪	(portscan) IP Distributed Protocol Scan	no	none
4	⚪	(portscan) IP Filtered Decoy Protocol Scan	no	none
5	⚪	(portscan) IP Filtered Distributed Protocol Scan	no	none
6	⚪	(portscan) IP Filtered Protocol Scan	no	none
7	⚪	(portscan) IP Protocol Scan	no	none
8	⚪	(portscan) TCP Decoy Portscan	no	none
9	⚪	(portscan) TCP Distributed Portscan	no	none
10	⚪	(portscan) TCP Filtered Decoy Portscan	no	none
11	⚪	(portscan) TCP Filtered Distributed Portscan	no	none
12	⚪	(portscan) TCP Filtered Portscan	no	none
13	⚪	(portscan) TCP Portscan	no	none
14	⚪	(portscan) UDP Decoy Portscan	no	none
15	⚪	(portscan) UDP Distributed Portscan	no	none
16	⚪	(portscan) UDP Filtered Decoy Portscan	no	none
17	⚪	(portscan) UDP Filtered Distributed Portscan	no	none
18	⚪	(portscan) UDP Filtered Portscan	no	none
19	⚪	(portscan) UDP Portscan	no	none
20	⚪	(sweep) ICMP Filtered Sweep	no	none
21	⚪	(sweep) ICMP Sweep	no	none
22	⚪	(sweep) IP Filtered Protocol Sweep	no	none
23	⚪	(sweep) IP Protocol Sweep	no	none
24	⚪	(sweep) TCP Filtered Port Sweep	no	none
25	⚪	(sweep) TCP Port Sweep	no	none
26	⚪	(sweep) UDP Filtered Port Sweep	no	none
27	⚪	(sweep) UDP Port Sweep	no	none

Page 1 of 1 | Show 50 items | Displaying 1 - 27 of 27

Flood Detection

Block Period: (1-3600 seconds)

✎ Edit | ⚡ Activate | ⚪ Inactivate | 📄 Log | ⚙️ Action

#	Status	Name	Log	Action	Threshold
1	⚪	(flood) ICMP Flood	no	none	2000
2	⚪	(flood) IP Flood	no	none	2000
3	⚪	(flood) TCP Flood	no	none	2000
4	⚪	(flood) UDP Flood	no	none	2000

Page 1 of 1 | Show 50 items | Displaying 1 - 4 of 4

OK | Cancel | Save

The following table describes the fields in this screen.

Table 136 Configuration > ADP > Profile > Traffic Anomaly

LABEL	DESCRIPTION
Name	<p>This is the name of the ADP profile. You may use 1-31 alphanumeric characters, underscores(_), or dashes (-), but the first character cannot be a number. This value is case-sensitive. These are valid, unique profile names:</p> <p>MyProfile mYProfile Mymy12_3-4</p> <p>These are invalid profile names:</p> <p>1mYProfile My Profile MyProfile? Whatalongprofilename123456789012</p>
Scan/Flood Detection	
Sensitivity	<p>(Scan detection only.) Select a sensitivity level so as to reduce false positives in your network. If you choose low sensitivity, then scan thresholds and sample times are set low, so you will have fewer logs and false positives; however some traffic anomaly attacks may not be detected.</p> <p>If you choose high sensitivity, then scan thresholds and sample times are set high, so most traffic anomaly attacks will be detected; however you will have more logs and false positives.</p>
Block Period	Specify for how many seconds the ZyWALL blocks all packets from being sent to the victim (destination) of a detected anomaly attack.
Activate	To turn on an entry, select it and click Activate .
Inactivate	To turn off an entry, select it and click Inactivate .
Log	To edit an item's log option, select it and use the Log icon. Select whether to have the ZyWALL generate a log (log), log and alert (log alert) or neither (no) when traffic matches this anomaly rule. See Chapter 44 on page 679 for more on logs.
Action	<p>To edit what action the ZyWALL takes when a packet matches a rule, select the signature and use the Action icon.</p> <p>none: The ZyWALL takes no action when a packet matches the signature(s).</p> <p>block: The ZyWALL silently drops packets that matches the rule. Neither sender nor receiver are notified.</p>
#	This is the entry's index number in the list.
Status	The activate (light bulb) icon is lit when the entry is active and dimmed when the entry is inactive.

Table 136 Configuration > ADP > Profile > Traffic Anomaly (continued)

LABEL	DESCRIPTION
Name	This is the name of the traffic anomaly rule. Click the Name column heading to sort in ascending or descending order according to the rule name.
Log	These are the log options. To edit this, select an item and use the Log icon.
Action	This is the action the ZyWALL should take when a packet matches a rule. To edit this, select an item and use the Action icon.
Threshold	For flood detection you can set the number of detected flood packets per second that causes the ZyWALL to take the configured action.
OK	Click OK to save your settings to the ZyWALL, complete the profile and return to the profile summary page.
Cancel	Click Cancel to return to the profile summary page without saving any changes.
Save	Click Save to save the configuration to the ZyWALL but remain in the same page. You may then go to the another profile screen (tab) in order to complete the profile. Click OK in the final profile screen to complete the profile.

29.3.5 Protocol Anomaly Profiles

Protocol anomaly is the third screen in anADP profile. Protocol anomaly (PA) rules check for protocol compliance against the relevant RFC (Request for Comments).

Protocol anomaly detection includes HTTP Inspection, TCP Decoder, UDP Decoder, and ICMP Decoder where each category reflects the packet type inspected.

Protocol anomaly rules may be updated when you upload new firmware.

29.3.6 Protocol Anomaly Configuration

In the **Configuration > Anti-X > ADP > Profile** screen, click the **Edit** icon or click the **Add** icon and choose a base profile, then select the **Protocol Anomaly** tab. If you made changes to other screens belonging to this profile, make sure you have clicked **OK** or **Save** to save the changes before selecting the **Protocol Anomaly** tab.

Figure 292 Profiles: Protocol Anomaly

Add Anomaly Profile

Traffic Anomaly | **Protocol Anomaly**

General

Name:

HTTP Inspection

Activate Inactivate Log Action

#	Status	Name	Log	Action
1	<input type="checkbox"/>	(http_inspect) APACHE-WHITESPACE ATTACK	no	none
2	<input type="checkbox"/>	(http_inspect) ASCII-ENCODING ATTACK	no	none
3	<input type="checkbox"/>	(http_inspect) BARE-BYTE-UNICODE-ENCODING ATTACK	no	none
4	<input type="checkbox"/>	(http_inspect) BASE36-ENCODING ATTACK	no	none
5	<input type="checkbox"/>	(http_inspect) DIRECTORY-TRAVERSAL ATTACK	no	none
6	<input type="checkbox"/>	(http_inspect) DOUBLE-DECODING ATTACK	no	none
7	<input type="checkbox"/>	(http_inspect) IIS-BACKSLASH-EVASION ATTACK	no	none
8	<input type="checkbox"/>	(http_inspect) IIS-UNICODE-CODEPOINT-ENCODING ATTACK	no	none
9	<input type="checkbox"/>	(http_inspect) MULTI-SLASH-ENCODING ATTACK	no	none
10	<input type="checkbox"/>	(http_inspect) NON-RFC-DEFINED-CHAR ATTACK	no	none
11	<input type="checkbox"/>	(http_inspect) NON-RFC-HTTP-DELIMITER ATTACK	no	none
12	<input type="checkbox"/>	(http_inspect) OVERSIZE-CHUNK-ENCODING ATTACK	no	none
13	<input type="checkbox"/>	(http_inspect) OVERSIZE-REQUEST-URI-DIRECTORY ATTACK	no	none
14	<input type="checkbox"/>	(http_inspect) SELF-DIRECTORY-TRAVERSAL ATTACK	no	none
15	<input type="checkbox"/>	(http_inspect) U-ENCODING ATTACK	no	none
16	<input type="checkbox"/>	(http_inspect) UNAUTHORIZED-PROXY-USE-DETECTED ATTACK	no	none
17	<input type="checkbox"/>	(http_inspect) UTF-8-ENCODING ATTACK	no	none
18	<input type="checkbox"/>	(http_inspect) WEBROOT-DIRECTORY-TRAVERSAL ATTACK	no	none

Page 1 of 1 | Show 50 items | Displaying 1 - 18 of 18

TCP Decoder

Activate Inactivate Log Action

#	Status	Name	Log	Action
1	<input type="checkbox"/>	(top_decoder) BAD-LENGTH-OPTIONS ATTACK	no	none
2	<input type="checkbox"/>	(top_decoder) EXPERIMENTAL-OPTIONS ATTACK	no	none
3	<input type="checkbox"/>	(top_decoder) OBSOLETE-OPTIONS ATTACK	no	none
4	<input type="checkbox"/>	(top_decoder) OVERSIZE-OFFSET ATTACK	no	none
5	<input type="checkbox"/>	(top_decoder) TRUNCATED-OPTIONS ATTACK	no	none
6	<input type="checkbox"/>	(top_decoder) TTCP-DETECTED ATTACK	no	none
7	<input type="checkbox"/>	(top_decoder) UNDERSIZE-LEN ATTACK	no	none
8	<input type="checkbox"/>	(top_decoder) UNDERSIZE-OFFSET ATTACK	no	none

Page 1 of 1 | Show 50 items | Displaying 1 - 8 of 8

UDP Decoder

Activate Inactivate Log Action

#	Status	Name	Log	Action
1	<input type="checkbox"/>	(udp_decoder) OVERSIZE-LEN ATTACK	no	none
2	<input type="checkbox"/>	(udp_decoder) TRUNCATED-HEADER ATTACK	no	none
3	<input type="checkbox"/>	(udp_decoder) UNDERSIZE-LEN ATTACK	no	none

Page 1 of 1 | Show 50 items | Displaying 1 - 3 of 3

ICMP Decoder

Activate Inactivate Log Action

#	Status	Name	Log	Action
1	<input type="checkbox"/>	(icmp_decoder) TRUNCATED-ADDRESS-HEADER ATTACK	no	none
2	<input type="checkbox"/>	(icmp_decoder) TRUNCATED-HEADER ATTACK	no	none
3	<input type="checkbox"/>	(icmp_decoder) TRUNCATED-TIMESTAMP-HEADER ATTACK	no	none

Page 1 of 1 | Show 50 items | Displaying 1 - 3 of 3

OK Cancel Save

The following table describes the fields in this screen.

Table 137 Configuration > ADP > Profile > Protocol Anomaly

LABEL	DESCRIPTION
Name	<p>This is the name of the profile. You may use 1-31 alphanumeric characters, underscores(_), or dashes (-), but the first character cannot be a number. This value is case-sensitive. These are valid, unique profile names:</p> <p>MyProfile mYProfile Mymy12_3-4</p> <p>These are invalid profile names:</p> <p>1mYProfile My Profile MyProfile? Whatalongprofilename123456789012</p>
HTTP Inspection/TCP Decoder/UDP Decoder/ICMP Decoder	
Activate	To turn on an entry, select it and click Activate .
Inactivate	To turn off an entry, select it and click Inactivate .
Log	To edit an item's log option, select it and use the Log icon. Select whether to have the ZyWALL generate a log (log), log and alert (log alert) or neither (no) when traffic matches this anomaly rule. See Chapter 44 on page 679 for more on logs.

Table 137 Configuration > ADP > Profile > Protocol Anomaly (continued)

LABEL	DESCRIPTION
Action	<p>To edit what action the ZyWALL takes when a packet matches a signature, select the signature and use the Action icon.</p> <p>original setting: Select this action to return each signature in a service group to its previously saved configuration.</p> <p>none: Select this action on an individual signature or a complete service group to have the ZyWALL take no action when a packet matches a rule.</p> <p>drop: Select this action on an individual signature or a complete service group to have the ZyWALL silently drop a packet that matches a rule. Neither sender nor receiver are notified.</p> <p>reject-sender: Select this action on an individual signature or a complete service group to have the ZyWALL send a reset to the sender when a packet matches the signature. If it is a TCP attack packet, the ZyWALL will send a packet with a 'RST' flag. If it is an ICMP or UDP attack packet, the ZyWALL will send an ICMP unreachable packet.</p> <p>reject-receiver: Select this action on an individual signature or a complete service group to have the ZyWALL send a reset to the receiver when a packet matches the rule. If it is a TCP attack packet, the ZyWALL will send a packet with an a 'RST' flag. If it is an ICMP or UDP attack packet, the ZyWALL will do nothing.</p> <p>reject-both: Select this action on an individual signature or a complete service group to have the ZyWALL send a reset to both the sender and receiver when a packet matches the rule. If it is a TCP attack packet, the ZyWALL will send a packet with a 'RST' flag to the receiver and sender. If it is an ICMP or UDP attack packet, the ZyWALL will send an ICMP unreachable packet.</p>
#	This is the entry's index number in the list.
Status	The activate (light bulb) icon is lit when the entry is active and dimmed when the entry is inactive.
Name	This is the name of the protocol anomaly rule. Click the Name column heading to sort in ascending or descending order according to the protocol anomaly rule name.
Activation	Click the icon to enable or disable a rule or group of rules.
Log	These are the log options. To edit this, select an item and use the Log icon.
Action	This is the action the ZyWALL should take when a packet matches a rule. To edit this, select an item and use the Action icon.
Log	Select whether to have the ZyWALL generate a log (log), log and alert (log alert) or neither (no) when traffic matches this anomaly rule. See Chapter 44 on page 679 for more on logs.
Action	<p>Select what the ZyWALL should do when a packet matches a rule.</p> <p>none: The ZyWALL takes no action when a packet matches the signature(s).</p> <p>block: The ZyWALL silently drops packets that matches the rule. Neither sender nor receiver are notified.</p>

Table 137 Configuration > ADP > Profile > Protocol Anomaly (continued)

LABEL	DESCRIPTION
OK	Click OK to save your settings to the ZyWALL, complete the profile and return to the profile summary page.
Cancel	Click Cancel to return to the profile summary page without saving any changes.
Save	Click Save to save the configuration to the ZyWALL but remain in the same page. You may then go to the another profile screen (tab) in order to complete the profile. Click OK in the final profile screen to complete the profile.

29.4 ADP Technical Reference

This section is divided into traffic anomaly background information and protocol anomaly background information.

Traffic Anomaly Background Information

The following sections may help you configure the traffic anomaly profile screen ([Section 29.3.4 on page 472](#)).

Port Scanning

An attacker scans device(s) to determine what types of network protocols or services a device supports. One of the most common port scanning tools in use today is Nmap.

Many connection attempts to different ports (services) may indicate a port scan. These are some port scan types:

- TCP Portscan
- UDP Portscan
- IP Portscan

An IP port scan searches not only for TCP, UDP and ICMP protocols in use by the remote computer, but also additional IP protocols such as EGP (Exterior Gateway Protocol) or IGP (Interior Gateway Protocol). Determining these additional protocols can help reveal if the destination device is a workstation, a printer, or a router.

Decoy Port Scans

Decoy port scans are scans where the attacker has spoofed the source address. These are some decoy scan types:

- TCP Decoy Portscan
- UDP Decoy Portscan
- IP Decoy Portscan

Distributed Port Scans

Distributed port scans are many-to-one port scans. Distributed port scans occur when multiple hosts query one host for open services. This may be used to evade intrusion detection. These are distributed port scan types:

- TCP Distributed Portscan
- UDP Distributed Portscan
- IP Distributed Portscan

Port Sweeps

Many different connection attempts to the same port (service) may indicate a port sweep, that is, they are one-to-many port scans. One host scans a single port on multiple hosts. This may occur when a new exploit comes out and the attacker is looking for a specific service. These are some port sweep types:

- TCP Portsweep
- UDP Portsweep
- IP Portsweep
- ICMP Portsweep

Filtered Port Scans

A filtered port scan may indicate that there were no network errors (ICMP unreachables or TCP RSTs) or responses on closed ports have been suppressed. Active network devices, such as NAT routers, may trigger these alerts if they send out many connection attempts within a very small amount of time. These are some filtered port scan examples.

- TCP Filtered Portscan
- UDP Filtered Portscan
- IP Filtered Portscan
- TCP Filtered Decoy Portscan
- UDP Filtered Decoy Portscan
- IP Filtered Decoy Portscan
- TCP Filtered Portsweep
- UDP Filtered Portsweep
- IP Filtered Portsweep

- ICMP Filtered
Portsweep
- IP Filtered
Distributed Portscan
- TCP Filtered Distributed
Portscan
- UDP Filtered
Distributed Portscan

Flood Detection

Flood attacks saturate a network with useless data, use up all available bandwidth, and therefore make communications in the network impossible.

ICMP Flood Attack

An ICMP flood is broadcasting many pings or UDP packets so that so much data is sent to the system, that it slows it down or locks it up.

Smurf

A smurf attacker (A) floods a router (B) with Internet Control Message Protocol (ICMP) echo request packets (pings) with the destination IP address of each packet as the broadcast address of the network. The router will broadcast the ICMP echo request packet to all hosts on the network. If there are numerous hosts, this will create a large amount of ICMP echo request and response traffic.

If an attacker (A) spoofs the source IP address of the ICMP echo request packet, the resulting ICMP traffic will not only saturate the receiving network (B), but the network of the spoofed source IP address (C).

Figure 293 Smurf Attack

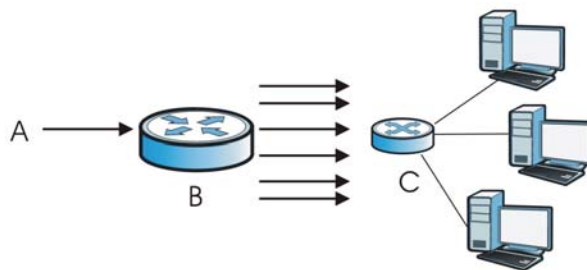

TCP SYN Flood Attack

Usually a client starts a session by sending a SYN (synchronize) packet to a server. The receiver returns an ACK (acknowledgment) packet and its own SYN, and then

the initiator responds with an ACK (acknowledgment). After this handshake, a connection is established.

Figure 294 TCP Three-Way Handshake

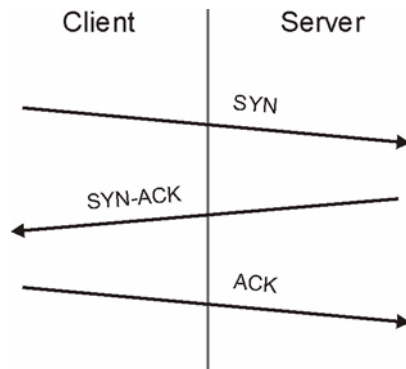

A SYN flood attack is when an attacker sends a series of SYN packets. Each packet causes the receiver to reply with a SYN-ACK response. The receiver then waits for the ACK that follows the SYN-ACK, and stores all outstanding SYN-ACK responses on a backlog queue. SYN-ACKs are only moved off the queue when an ACK comes back or when an internal timer ends the three-way handshake. Once the queue is full, the system will ignore all incoming SYN requests, making the system unavailable for other users.

Figure 295 SYN Flood

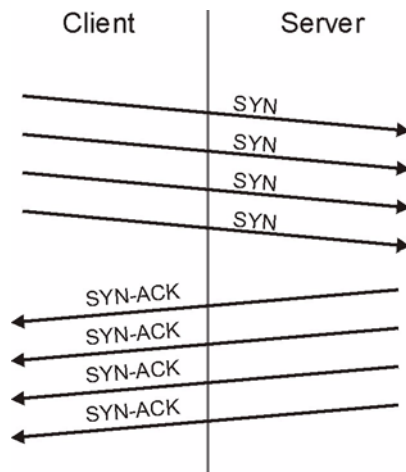

LAND Attack

In a LAND attack, hackers flood SYN packets into a network with a spoofed source IP address of the network itself. This makes it appear as if the computers in the network sent the packets to themselves, so the network is unavailable while they try to respond to themselves.

UDP Flood Attack

UDP is a connection-less protocol and it does not require any connection setup procedure to transfer data. A UDP flood attack is possible when an attacker sends a UDP packet to a random port on the victim system. When the victim system receives a UDP packet, it will determine what application is waiting on the destination port. When it realizes that there is no application that is waiting on the port, it will generate an ICMP packet of destination unreachable to the forged source address. If enough UDP packets are delivered to ports on victim, the system will go down.

Protocol Anomaly Background Information

The following sections may help you configure the protocol anomaly profile screen (see [Section 29.3.5 on page 475](#))

HTTP Inspection and TCP/UDP/ICMP Decoders

The following table gives some information on the HTTP inspection, TCP decoder, UDP decoder and ICMP decoder ZyWALL protocol anomaly rules.

Table 138 HTTP Inspection and TCP/UDP/ICMP Decoders

LABEL	DESCRIPTION
HTTP Inspection	
APACHE-WHITESPACE ATTACK	This rule deals with non-RFC standard of tab for a space delimiter. Apache uses this, so if you have an Apache server, you need to enable this option.
ASCII-ENCODING ATTACK	This rule can detect attacks where malicious attackers use ASCII-encoding to encode attack strings. Attackers may use this method to bypass system parameter checks in order to get information or privileges from a web server.
BARE-BYTE-UNICODE-ENCODING ATTACK	Bare byte encoding uses non-ASCII characters as valid values in decoding UTF-8 values. This is NOT in the HTTP standard, as all non-ASCII values have to be encoded with a %. Bare byte encoding allows the user to emulate an IIS server and interpret non-standard encodings correctly.
BASE36-ENCODING ATTACK	This is a rule to decode base36-encoded characters. This rule can detect attacks where malicious attackers use base36-encoding to encode attack strings. Attackers may use this method to bypass system parameter checks in order to get information or privileges from a web server.
DIRECTORY-TRAVERSAL ATTACK	This rule normalizes directory traversals and self-referential directories. So, "/abc/this_is_not_a_real_dir/../xyz" get normalized to "/abc/xyz". Also, "/abc/./xyz" gets normalized to "/abc/xyz". If a user wants to configure an alert, then specify "yes", otherwise "no". This alert may give false positives since some web sites refer to files using directory traversals.

Table 138 HTTP Inspection and TCP/UDP/ICMP Decoders (continued)

LABEL	DESCRIPTION
DOUBLE-ENCODING ATTACK	This rule is IIS specific. IIS does two passes through the request URI, doing decodes in each one. In the first pass, IIS encoding (UTF-8 unicode, ASCII, bare byte, and %u) is done. In the second pass ASCII, bare byte, and %u encodings are done.
IIS-BACKSLASH-EVASION ATTACK	This is an IIS emulation rule that normalizes backslashes to slashes. Therefore, a request-URI of "/abc\xyz" gets normalized to "/abc/xyz".
IIS-UNICODE-CODEPOINT-ENCODING ATTACK	This rule can detect attacks which send attack strings containing non-ASCII characters encoded by IIS Unicode. IIS Unicode encoding references the unicode.map file. Attackers may use this method to bypass system parameter checks in order to get information or privileges from a web server.
MULTI-SLASH-ENCODING ATTACK	This rule normalizes multiple slashes in a row, so something like: "abc////////xyz" get normalized to "abc/xyz".
NON-RFC-DEFINED-CHAR ATTACK	This rule lets you receive a log or alert if certain non-RFC characters are used in a request URI. For instance, you may want to know if there are NULL bytes in the request-URI.
NON-RFC-HTTP-DELIMITER ATTACK	This is when a newline "\n" character is detected as a delimiter. This is non-standard but is accepted by both Apache and IIS web servers.
OVERSIZE-CHUNK-ENCODING ATTACK	This rule is an anomaly detector for abnormally large chunk sizes. This picks up the apache chunkencoding exploits and may also be triggered on HTTP tunneling that uses chunk encoding.
OVERSIZE-REQUEST-URI-DIRECTORY ATTACK	This rule takes a non-zero positive integer as an argument. The argument specifies the max character directory length for URL directory. If a URL directory is larger than this argument size, an alert is generated. A good argument value is 300 characters. This should limit the alerts to IDS evasion type attacks, like whisker.
SELF-DIRECTORY-TRAVERSAL ATTACK	This rule normalizes self-referential directories. So, "/abc/./xyz" gets normalized to "/abc/xyz".
U-ENCODING ATTACK	This rule emulates the IIS %u encoding scheme. The %u encoding scheme starts with a %u followed by 4 characters, like %uXXXX. The XXXX is a hex encoded value that correlates to an IIS unicode codepoint. This is an ASCII value. An ASCII character is encoded like, %u002f = /, %u002e = ., etc.
UTF-8-ENCODING ATTACK	The UTF-8 decode rule decodes standard UTF-8 unicode sequences that are in the URI. This abides by the unicode standard and only uses % encoding. Apache uses this standard, so for any Apache servers, make sure you have this option turned on. When this rule is enabled, ASCII decoding is also enabled to enforce correct functioning.

Table 138 HTTP Inspection and TCP/UDP/ICMP Decoders (continued)

LABEL	DESCRIPTION
WEBROOT-DIRECTORY-TRAVERSAL ATTACK	This is when a directory traversal traverses past the web server root directory. This generates much fewer false positives than the directory option, because it doesn't alert on directory traversals that stay within the web server directory structure. It only alerts when the directory traversals go past the web server root directory, which is associated with certain web attacks.
TCP Decoder	
BAD-LENGTH-OPTIONS ATTACK	This is when a TCP packet is sent where the TCP option length field is not the same as what it actually is or is 0. This may cause some applications to crash.
EXPERIMENTAL-OPTIONS ATTACK	This is when a TCP packet is sent which contains non-RFC-complaint options. This may cause some applications to crash.
OBSOLETE-OPTIONS ATTACK	This is when a TCP packet is sent which contains obsolete RFC options.
OVERSIZE-OFFSET ATTACK	This is when a TCP packet is sent where the TCP data offset is larger than the payload.
TRUNCATED-OPTIONS ATTACK	This is when a TCP packet is sent which doesn't have enough data to read. This could mean the packet was truncated.
TTCP-DETECTED ATTACK	T/TCP provides a way of bypassing the standard three-way handshake found in TCP, thus speeding up transactions. However, this could lead to unauthorized access to the system by spoofing connections.
UNDERSIZE-LEN ATTACK	This is when a TCP packet is sent which has a TCP datagram length of less than 20 bytes. This may cause some applications to crash.
UNDERSIZE-OFFSET ATTACK	This is when a TCP packet is sent which has a TCP header length of less than 20 bytes. This may cause some applications to crash.
UDP Decoder	
OVERSIZE-LEN ATTACK	This is when a UDP packet is sent which has a UDP length field of greater than the actual packet length. This may cause some applications to crash.
TRUNCATED-HEADER ATTACK	This is when a UDP packet is sent which has a UDP datagram length of less the UDP header length. This may cause some applications to crash.
UNDERSIZE-LEN ATTACK	This is when a UDP packet is sent which has a UDP length field of less than 8 bytes. This may cause some applications to crash.
ICMP Decoder	
TRUNCATED-ADDRESS-HEADER ATTACK	This is when an ICMP packet is sent which has an ICMP datagram length of less than the ICMP address header length. This may cause some applications to crash.

Table 138 HTTP Inspection and TCP/UDP/ICMP Decoders (continued)

LABEL	DESCRIPTION
TRUNCATED-HEADER ATTACK	This is when an ICMP packet is sent which has an ICMP datagram length of less than the ICMP header length. This may cause some applications to crash.
TRUNCATED- TIMESTAMP-HEADER ATTACK	This is when an ICMP packet is sent which has an ICMP datagram length of less than the ICMP Time Stamp header length. This may cause some applications to crash.

Content Filtering

30.1 Overview

Use the content filtering feature to control access to specific web sites or web content.

30.1.1 What You Can Do in this Chapter

- Use the **General** screens ([Section 30.2 on page 489](#)) to configure global content filtering settings, configure content filtering policies, and check the content filtering license status.
- Use the **Filter Profile** screens ([Section 30.4 on page 494](#)) to set up content filtering profiles.

30.1.2 What You Need to Know

Content Filtering

Content filtering allows you to block certain web features, such as cookies, and/or block access to specific web sites. It can also block access to specific categories of web site content. You can create different content filter policies for different addresses, schedules, users or groups and content filter profiles. For example, you can configure one policy that blocks John Doe's access to arts and ainment web pages during the workday and another policy that lets him access them after work.

Content Filtering Policies

A content filtering policy allows you to do the following.

- Use schedule objects to define when to apply a content filter profile.
- Use address and/or user/group objects to define to whose web access to apply the content filter profile.
- Apply a content filter profile that you have custom-tailored.

Content Filtering Profiles

A content filtering profile conveniently stores your custom settings for the following features.

- **Category-based Blocking**
The ZyWALL can block access to particular categories of web site content, such as pornography or racial intolerance.
- **Restrict Web Features**
The ZyWALL can disable web proxies and block web features such as ActiveX controls, Java applets and cookies.
- **Customize Web Site Access**
You can specify URLs to which the ZyWALL blocks access. You can alternatively block access to all URLs except ones that you specify. You can also have the ZyWALL block access to URLs that contain particular keywords.

Content Filtering Configuration Guidelines

When the ZyWALL receives an HTTP request, the content filter searches for a policy that matches the source address and time (schedule). The content filter checks the policies in order (based on the policy numbers). When a matching policy is found, the content filter allows or blocks the request depending on the settings of the filtering profile specified by the policy. Some requests may not match any policy. The ZyWALL allows the request if the default policy is not set to block. The ZyWALL blocks the request if the default policy is set to block.

External Web Filtering Service

When you register for and enable the external web filtering service, your ZyWALL accesses an external database that has millions of web sites categorized based on content. You can have the ZyWALL block, block and/or log access to web sites based on these categories.

Keyword Blocking URL Checking

The ZyWALL checks the URL's domain name (or IP address) and file path separately when performing keyword blocking.

The URL's domain name or IP address is the characters that come before the first slash in the URL. For example, with the URL www.zyxel.com.tw/news/pressroom.php, the domain name is www.zyxel.com.tw.

The file path is the characters that come after the first slash in the URL. For example, with the URL www.zyxel.com.tw/news/pressroom.php, the file path is [news/pressroom.php](http://www.zyxel.com.tw/news/pressroom.php).

Since the ZyWALL checks the URL's domain name (or IP address) and file path separately, it will not find items that go across the two. For example, with the URL www.zyxel.com.tw/news/pressroom.php, the ZyWALL would find "tw" in the domain name (www.zyxel.com.tw). It would also find "news" in the file path (news/pressroom.php) but it would not find "tw/news".

Finding Out More

- See [Section 6.5.18 on page 102](#) for related information on these screens.
- See [Section 30.7 on page 511](#) for content filtering background/technical information.

30.1.3 Before You Begin

- You must configure an address object, a schedule object and a filtering profile before you can set up a content filter policy.
- You must subscribe to use the external database content filtering (see the **Licensing > Registration** screens).

30.2 Content Filter General Screen

Click **Configuration > Anti-X > Content Filter > General** to open the **Content Filter General** screen. Use this screen to enable content filtering, view and order

your list of content filter policies, create a denial of access message or specify a redirect URL and check your external web filtering service registration status.

Figure 296 Configuration > Anti-X > Content Filter > General

The following table describes the labels in this screen.

Table 139 Configuration > Anti-X > Content Filter > General

LABEL	DESCRIPTION
General Settings	
Enable Content Filter	Select this check box to enable the content filter.
Enable Content Filter Report Service	Select this check box to have the ZyWALL collect category-based content filtering statistics.
Policies	This is a list of the configured content filter policies.
Block web access when no policy is applied	Select this check box to stop users from accessing the Internet by default when their attempted access does not match a content filter policy.
Add	Click this to create a new entry. Select an entry and click Add to create a new entry after the selected entry.
Edit	Select an entry and click this to be able to modify it.
Remove	Select an entry and click this to delete it.
Activate	To turn on an entry, select it and click Activate .
Inactivate	To turn off an entry, select it and click Inactivate .

Table 139 Configuration > Anti-X > Content Filter > General (continued)

LABEL	DESCRIPTION
Move	To change an entry's position in the numbered list, select it and click Move to display a field to type a number for where you want to put that entry and press [ENTER] to move the entry to the number that you typed.
#	This column lists the index numbers of the content filter policies. The ordering of the content filter policies is important as they are used in the order they are listed. The ZyWALL checks requests for Web sessions against the list of content filter policies (starting from the first in the list). The ZyWALL's content filter feature blocks or allows the Web session according to the first matching content filter policy and does not check any other content filter policies. The ZyWALL does not perform content filter on Web session requests that do not match any of the content filter policies.
Status	The activate (light bulb) icon is lit when the entry is active and dimmed when the entry is inactive.
Address	A content filter policy applies to web access from the IP addresses listed here. any means the content filter policy applies to all of the web access requests that the ZyWALL receives from any IP address.
Schedule	This column displays the name of the schedule for each content filter policy. You can define different policies for different time periods. none means the content filter policy applies all of the time.
User	This column displays the individual or group to which this policy applies. any means the content filter policy applies to all of the web access requests that the ZyWALL receives from any user.
Filter Profile	This column displays the name of the content filter profile that each content filter policy uses. The content filter profile defines to which web services, web sites or web site categories access is to be allowed or denied.
Denied Access Message	Enter a message to be displayed when content filter blocks access to a web page. Use up to 127 characters (0-9a-zA-Z;/?:@&=+\$\._!~*()*%,"). For example, "Access to this web page is not allowed. Please contact the network administrator". It is also possible to leave this field blank if you have a URL specified in the Redirect URL field. In this case if the content filter blocks access to a web page, the ZyWALL just opens the web page you specified without showing a denied access message.
Redirect URL	Enter the URL of the web page to which you want to send users when their web access is blocked by content filter. The web page you specify here opens in a new frame below the denied access message. Use "http://" or "https://" followed by up to 262 characters (0-9a-zA-Z;/?:@&=+\$\._!~*()*%"). For example, http://192.168.1.17/ blocked access.

Table 139 Configuration > Anti-X > Content Filter > General (continued)

LABEL	DESCRIPTION
License Status	<p>This read-only field displays the status of your content-filtering database service registration.</p> <p>Not Licensed displays if you have not successfully registered and activated the service.</p> <p>Expired displays if your subscription to the service has expired.</p> <p>Licensed displays if you have successfully registered the ZyWALL and activated the service.</p> <p>After you register for content filter, you can see Chapter 30 on page 494 for how to use the Test Against Web Filtering Server button. When the content filter is active, you should see the web page's category. The query fails if the content filter is not active.</p> <p>You can view content filter reports after you register the ZyWALL and activate the subscription service in the Registration screen (see Chapter 31 on page 513).</p>
License Type	<p>This read-only field displays what kind of service registration you have for the content-filtering database.</p> <p>None displays if you have not successfully registered and activated the service.</p> <p>Standard displays if you have successfully registered the ZyWALL and activated the service.</p> <p>Trial displays if you have successfully registered the ZyWALL and activated the trial service subscription.</p>
Apply new Registration	<p>This link appears if you have not registered for the service or only have the trial registration. Click this link to go to the screen where you can register for the service.</p>
Expiration Date	<p>This field displays the date your service license expires.</p>
Apply	<p>Click Apply to save your changes back to the ZyWALL.</p>
Reset	<p>Click Reset to return the screen to its last-saved settings.</p>

30.3 Content Filter Policy Add or Edit Screen

Click **Configuration > Anti-X > Content Filter > General > Add or Edit** to open the **Content Filter Policy** screen. Use this screen to configure a content

filter policy. A content filter policy defines which content filter profile should be applied, when it should be applied, and to whose web access it should be applied.

Figure 297 Configuration > Anti-X > Content Filter > General > Add I

The following table describes the labels in this screen.

Table 140 Configuration > Anti-X > Content Filter > General > Add

LABEL	DESCRIPTION
Create new Object	Use this to configure any new settings objects that you need to use in this screen.
Schedule	Select a schedule to define when to apply this content filter policy. You can define different policies for different time periods. For example, you could have one policy that blocks access to certain categories of web sites during working hours and another policy that allows access to certain categories after the work day is over. Select none to have the content filter policy apply all of the time.
Address	Select the address or address group for which you want to use this policy. Select any to have the content filter policy apply to all of the web access requests that the ZyWALL receives from any IP address.
Filter Profile	Use the drop-down list box to select the content filter profile that you want to use for this policy. The content filter profile defines to which web services, web sites or web site categories access is to be allowed or denied. Use the content filter Filter Profile screens to configure the profiles.
User/Group	Use the drop-down list box to select the individual or group for which you want to use this policy. Select any to have the content filter policy apply to all of the web access requests that the ZyWALL receives from any user.
OK	Click OK to save your changes back to the ZyWALL.
Cancel	Click Cancel to exit this screen without saving your changes.

30.4 Content Filter Profile Screen

Click **Configuration > Anti-X > Content Filter > Filter Profile** to open the **Filter Profile** screen. A content filter profile defines to which web services, web sites or web site categories access is to be allowed or denied.

Figure 298 Configuration > Anti-X > Content Filter > Filter Profile



The following table describes the labels in this screen.

Table 141 Configuration > Anti-X > Content Filter > Filter Profile

LABEL	DESCRIPTION
Add	Click this to create a new entry.
Edit	Select an entry and click this to be able to modify it.
Remove	Select an entry and click this to delete it.
#	This column lists the index numbers of the content filter profiles.
Filter Profile Name	This column lists the names of the content filter profiles.

30.5 Content Filter Categories Screen

Click **Configuration > Anti-X > Content Filter > Filter Profile > Add or Edit** to open the **Categories** screen. Use this screen to enable external database content filtering and select which web site categories to block and/or log.

Note: You must register for external content filtering before you can use it. See [Section 10.2 on page 212](#) for how to register.

See [Chapter 31 on page 513](#) for how to view content filtering reports.

Figure 299 Configuration > Anti-X > Content Filter > Filter Profile > Add

Add Filter Profile

Category Service | Custom Service

General Settings

License Status: Licensed

License Type: Trial

Name:

Enable Content Filter Category Service

Action for Unsafe Web Pages: Warn Log

Action for Managed Web Pages: Block Log

Action for Unrated Web Pages: Warn Log

Action When Category Server Is Unavailable: Warn Log

Select Categories

Select All Categories Clear All Categories

Security Threat (unsafe)

Phishing Spyware/Malware Sources Spyware Effects/Privacy Concerns

Proxy Avoidance

Managed Categories

Adult Related

Adult/Mature Content Intimate Apparel/Swimsuit Open/Mixed Content

Alternative Sexuality/Lifestyles Nudity Sex Education Extreme Pornography

Liability Concerns

Illegal Drugs Violence/Hate/Racism Illegal/Questionable Weapons Gambling

Security Concerns

Hacking Potentially Unwanted Software Pay to Surf Remote Access Tools Placeholders Suspicious

File Transfer

Online Storage Peer-to-Peer Software Downloads

Society/Government

Alternative Spirituality/Occult LGBT Religion Cultural/Charitable Organizations Military Society/Lifestyle Government/Legal Political/Activist Groups

Social Interaction

Blogs Personal Pages Social Networking Greeting Cards Personals/Dating

Multimedia

Audio/Video Clips TV/Video Streams Media Sharing Radio/Audio Streams

Communication

Chat/Instant Messaging Online Meetings Email Newsgroups/Forums Internet Telephony

Figure 300 Configuration > Anti-X > Content Filter > Filter Profile > Add (Continue)

Multimedia

- Audio/Video Clips
- TV/Video Streams
- Media Sharing
- Radio/Audio Streams

Communication

- Chat/Instant Messaging
- Online Meetings
- Email
- Newsgroups/Forums
- Internet Telephony

Health Related

- Abortion
- Restaurants/Dining/Food
- Alcohol
- Tobacco
- Health

Leisure

- Art/Culture
- Games
- Entertainment
- Humor/Jokes
- For Kids
- Sports/Recreation

Commerce

- Brokerage/Trading
- Job Search/Careers
- Shopping
- Web Advertisements
- Business/Economy
- Real Estate
- Travel
- Financial Services
- Auctions
- Vehicles

Technology

- Computers/Internet
- Web Hosting
- Content Servers
- Web Applications
- Non Viewable

Information Related

- Education
- Search Engines/Portals
- News/Media
- Translation
- Reference

Test Web Site Category

URL to test:

[If you think the category is incorrect, click this link to submit a request to review it.](#)

The following table describes the labels in this screen.

Table 142 Configuration > Anti-X > Content Filter > Filter Profile > Add

LABEL	DESCRIPTION
License Status	<p>This read-only field displays the status of your content-filtering database service registration.</p> <p>Not Licensed displays if you have not successfully registered and activated the service.</p> <p>Expired displays if your subscription to the service has expired.</p> <p>Licensed displays if you have successfully registered the ZyWALL and activated the service.</p> <p>After you register for content filter, you can see Chapter 30 on page 494 for how to use the Test Against Web Filtering Server button. When the content filter is active, you should see the web page's category. The query fails if the content filter is not active.</p> <p>You can view content filter reports after you register the ZyWALL and activate the subscription service in the Registration screen (see Chapter 31 on page 513).</p>
License Type	<p>This read-only field displays what kind of service registration you have for the content-filtering database.</p> <p>None displays if you have not successfully registered and activated the service.</p> <p>Standard displays if you have successfully registered the ZyWALL and activated the standard content filtering service.</p> <p>Trial displays if you have successfully registered the ZyWALL and activated the trial service subscription.</p>
Name	<p>Enter a descriptive name for this content filtering profile name. You may use 1-31 alphanumeric characters, underscores(_), or dashes (-), but the first character cannot be a number. This value is case-sensitive.</p>
Enable Content Filter Category Service	<p>Enable external database content filtering to have the ZyWALL check an external database to find to which category a requested web page belongs. The ZyWALL then blocks or forwards access to the web page depending on the configuration of the rest of this page.</p>

Table 142 Configuration > Anti-X > Content Filter > Filter Profile > Add (continued)

LABEL	DESCRIPTION
Action for Unsafe Web Pages	<p>Select Pass to allow users to access web pages that match the unsafe categories that you select below.</p> <p>Select Block to prevent users from accessing web pages that match the unsafe categories that you select below. When external database content filtering blocks access to a web page, it displays the denied access message that you configured in the Content Filter General screen along with the category of the blocked web page.</p> <p>Select Warn to display a warning message before allowing users to access web pages that match the unsafe categories that you select below.</p> <p>Select Log to record attempts to access web pages that match the unsafe categories that you select below.</p>
Action for Managed Web Pages	<p>Select Pass to allow users to access web pages that match the other categories that you select below.</p> <p>Select Block to prevent users from accessing web pages that match the other categories that you select below. When external database content filtering blocks access to a web page, it displays the denied access message that you configured in the Content Filter General screen along with the category of the blocked web page.</p> <p>Select Log to record attempts to access web pages that match the other categories that you select below.</p>
Action for Unrated Web Pages	<p>Select Pass to allow users to access web pages that the external web filtering service has not categorized.</p> <p>Select Block to prevent users from accessing web pages that the external web filtering service has not categorized. When the external database content filtering blocks access to a web page, it displays the denied access message that you configured in the Content Filter General screen along with the category of the blocked web page.</p> <p>Select Warn to display a warning message before allowing users to access web pages that the external web filtering service has not categorized.</p> <p>Select Log to record attempts to access web pages that are not categorized.</p>

Table 142 Configuration > Anti-X > Content Filter > Filter Profile > Add (continued)

LABEL	DESCRIPTION
Action When Category Server Is Unavailable	<p>Select Pass to allow users to access any requested web page if the external content filtering database is unavailable.</p> <p>Select Block to block access to any requested web page if the external content filtering database is unavailable.</p> <p>Select Warn to display a warning message before allowing users to access any requested web page if the external content filtering database is unavailable.</p> <p>The following are possible causes for the external content filtering server not being available:</p> <ul style="list-style-type: none"> • There is no response from the external content filtering server within the time period specified in the Content Filter Server Unavailable Timeout field. • The ZyWALL is not able to resolve the domain name of the external content filtering database. • There is an error response from the external content filtering database. This can be caused by an expired content filtering registration (External content filtering's license key is invalid"). <p>Select Log to record attempts to access web pages that occur when the external content filtering database is unavailable.</p>
Select Categories	
Select All Categories	Select this check box to restrict access to all site categories listed below.
Clear All Categories	Select this check box to clear the selected categories below.
Security Threat (unsafe)	These are categories of web pages that are known to pose a threat to users or their computers.
Phishing	This category includes pages that are designed to appear as a legitimate bank or retailer with the intent to fraudulently capture sensitive data (i.e. credit card numbers, pin numbers).
Spyware/Malware Sources	This category includes pages which distribute spyware and other malware. Spyware and malware are defined as software which takes control of your computer, modifies computer settings, collects or reports personal information, or misrepresents itself by tricking users to install, download, or enter personal information. This includes drive-by downloads; browser hijackers; dialers; intrusive advertising; any program which modifies your homepage, bookmarks, or security settings; and keyloggers. It also includes any software which bundles spyware (as defined above) as part of its offering. Information collected or reported is "personal" if it contains uniquely identifying data, such as e-mail addresses, name, social security number, IP address, etc. A site is not classified as spyware if the user is reasonably notified that the software will perform these actions (that is, it alerts that it will send personal information, be installed, or that it will log keystrokes). Note: Sites rated as spyware should have a second category assigned with them.

Table 142 Configuration > Anti-X > Content Filter > Filter Profile > Add (continued)

LABEL	DESCRIPTION
Spyware Effects/ Privacy Concerns	This category includes pages to which spyware (as defined in the Spyware/Malware Sources category) reports its findings or from which it alone downloads advertisements. Also includes sites that contain serious privacy issues, such as "phone home" sites to which software can connect and send user info; sites that make extensive use of tracking cookies without a posted privacy statement; and sites to which browser hijackers redirect users. Usually does not include sites that can be marked as Spyware/Malware. Note: Sites rated as spyware effects typically have a second category assigned with them.
Proxy Avoidance	This category includes pages that provide information on how to bypass proxy server/appliance features or gain access to URLs in any way that bypasses the proxy server/appliance. It also includes any service that will allow a person to bypass the content filtering feature, such as anonymous surfing services.
Managed Categories	These are categories of web pages based on their content. Select categories in this section to control access to specific types of Internet content. You must have the standard content filtering license to filter these categories.
Adult Related	
Adult/Mature Content	This category includes pages that contain material of adult nature that does not necessarily contain excessive violence, sexual content, or nudity. These pages include very profane or vulgar content and pages that are not appropriate for children.
Alternative Sexuality/Lifestyles	This category includes pages that provide information, promote, or cater to alternative sexual expressions in their myriad forms. It includes but is not limited to the full range of non-traditional sexual practices, interests, orientations or fetishes. It does not include sites that are sexually gratuitous in nature which would typically fall under the Pornography category, nor does it include lesbian, gay, bi-sexual, transgender or any sites which speak to one's sexual identity.
Extreme	This category includes pages that are extreme in nature and not suitable for general viewership. Includes sites that revel in or glorify gore, human or animal suffering, scatological or other aberrant behaviors, perversities, or debaucheries. Visual or written depictions deemed to be of an unusually horrific nature are included. These sites are salacious that are bereft of historical context, educational value or artistic merit created solely to debase, dehumanize or shock. Examples include necrophilia, cannibalism, scat and amputee fetish sites.
Intimate Apparel/ Swimsuit	This category includes pages that contain images or offer the sale of swimsuits or intimate apparel or other types of suggestive clothing. It does not include pages selling undergarments as a subsection of other products offered.

Table 142 Configuration > Anti-X > Content Filter > Filter Profile > Add (continued)

LABEL	DESCRIPTION
Nudity	This category includes pages containing nude or seminude depictions of the human body. These depictions are not necessarily sexual in intent or effect, but may include pages containing nude paintings or photo galleries of artistic nature. This category also includes nudist or naturist pages that contain pictures of nude individuals.
Pornography	This category includes pages that contain sexually explicit material for the purpose of arousing a sexual or prurient interest.
Open/Mixed Content	This category includes pages that contain generally non-offensive content but that also have potentially objectionable content such as adult or pornographic material.
Sex Education	This category includes pages that provide graphic information (sometimes graphic) on reproduction, sexual development, safe sex practices, sexuality, birth control, and sexual development. It also includes pages that offer tips for better sex as well as products used for sexual enhancement.
Liability Concerns	
Illegal Drugs	This category includes pages that promote, offer, sell, supply, encourage or otherwise advocate the illegal use, cultivation, manufacture, or distribution of drugs, pharmaceuticals, intoxicating plants or chemicals and their related paraphernalia.
Illegal/Questionable	<p>This category includes pages that advocate or give advice on performing illegal acts such as service theft, evading law enforcement, fraud, burglary techniques and plagiarism. It also includes pages that provide or sell questionable educational materials, such as term papers.</p> <p>Note: This category includes sites identified as being malicious in any way (such as having viruses, spyware and etc.).</p>
Gambling	This category includes pages where a user can place a bet or participate in a betting pool (including lotteries) online. It also includes pages that provide information, assistance, recommendations, or training on placing bets or participating in games of chance. It does not include pages that sell gambling related products or machines. It also does not include pages for offline casinos and hotels (as long as those pages do not meet one of the above requirements).
Violence/Hate/Racism	This category includes pages that depict extreme physical harm to people or property, or that advocate or provide instructions on how to cause such harm. It also includes pages that advocate, depict hostility or aggression toward, or denigrate an individual or group on the basis of race, religion, gender, nationality, ethnic origin, or other characteristics.
Weapons	This category includes pages that sell, review, or describe weapons such as guns, knives or martial arts devices, or provide information on their use, accessories, or other modifications. It does not include pages that promote collecting weapons, or groups that either support or oppose weapons use.

Table 142 Configuration > Anti-X > Content Filter > Filter Profile > Add (continued)

LABEL	DESCRIPTION
Security Concerns	
Hacking	This category includes pages that distribute, promote, or provide hacking tools and/or information which may help gain unauthorized access to computer systems and/or computerized communication systems. Hacking encompasses instructions on illegal or questionable tactics, such as creating viruses, distributing cracked or pirated software, or distributing other protected intellectual property.
Pay to Surf	This category includes pages that pay users in the form of cash or prizes, for clicking on or reading specific links, email, or web pages.
Placeholders	This category includes pages that are under construction, parked domains, search-bait or otherwise generally having no useful value.
Potentially Unwanted Software	This category includes pages that contain distribute software that is not malicious but may be unwanted within an organization such as intrusive adware and hoaxes.
Remote Access Tools	This category includes pages that primarily focus on providing information about and/or methods that enables authorized access to and use of a desktop computer or private network remotely.
Suspicious	This category includes pages considered to have suspicious content and/or intent that poses an elevated security or privacy risk. This is determined by analysis of web reputation factors. It also includes sites that are part of the Web and email spam ecosystem. Sites that are determined to be clearly malicious or benign will be placed in a different category.
File Transfer	
Online Storage	This category includes pages that provide a secure, encrypted, off-site backup and restoration of personal data. These online repositories are typically used to store, organize and share videos, music, movies, photos, documents and other electronically formatted information. Sites that fit this criteria essentially act as your personal hard drive on the Internet.
Peer-to-Peer	This category includes pages that distribute software to facilitate the direct exchange of files between users, including software that enables file search and sharing across a network without dependence on a central server.
Software Downloads	This category includes pages that are dedicated to the electronic download of software packages, whether for payment or at no charge.
Society/Government	

Table 142 Configuration > Anti-X > Content Filter > Filter Profile > Add (continued)

LABEL	DESCRIPTION
Alternative Spirituality/Occult	This category includes pages that promote and provide information on religions such as Wicca, Witchcraft or Satanism. Occult practices, atheistic views, voodoo rituals or any other form of mysticism are represented here. Includes sites that endorse or offer methods, means of instruction, or other resources to affect or influence real events through the use of spells, incantations, curses and magic powers. This category includes sites which discuss or deal with paranormal or unexplained events.
Cultural/Charitable Organizations	This category includes pages that nurture cultural understanding and foster volunteerism such as 4H, the Lions and Rotary Clubs. Also encompasses non-profit associations that cultivate philanthropic or relief efforts. Sites that provide a learning environment or cultural refinement/awareness outside of the strictures of formalized education such as museums and planetariums are included under this heading.
Government/Legal	This category includes pages sponsored by or which provide information on government, government agencies and government services such as taxation and emergency services. It also includes pages that discuss or explain laws of various governmental entities.
LGBT	This category includes pages that provide information regarding, support, promote, or cater to one's sexual orientation or gender identity including but not limited to lesbian, gay, bi-sexual, and transgender sites. It does not include sites that are sexually gratuitous in nature which would typically fall under the Pornography category.
Military	This category includes pages that promote or provide information on military branches or armed services.
Political/Activist Groups	This category includes pages sponsored by or which provide information on political parties, special interest groups, or any organization that promotes change or reform in public policy, public opinion, social practice, or economic activities.
Religion	This category includes pages that promote and provide information on conventional or unconventional religious or quasi-religious subjects, as well as churches, synagogues, or other houses of worship. It does not include pages containing alternative religions such as Wicca or witchcraft or atheist beliefs (Alternative Spirituality/Occult).
Society/Lifestyle	This category includes pages providing information on matters of daily life. This does not include pages relating to airmen, sports, jobs, sex or pages promoting alternative lifestyles such as homosexuality. Personal homepages fall within this category if they cannot be classified in another category.
Social Interaction	
Blogs Personal Pages	This category includes pages that offer access to Usenet news groups or other messaging or bulletin board systems. Also, blog specific sites or an individual with his own blog. This does not include social networking communities with blogs.

Table 142 Configuration > Anti-X > Content Filter > Filter Profile > Add (continued)

LABEL	DESCRIPTION
Greeting Cards	This category includes pages that facilitate the sending of electronic greeting cards, animated cards, or similar electronic messages typically used to mark an event or occasion.
Personals/Dating	This category includes pages that promote interpersonal relationships.
Social Networking	This category includes pages that enable people to connect with others to form an online community. Typically members describe themselves in personal web page profiles and form interactive networks, linking them with other members based on common interests or acquaintances. Instant messaging, file sharing and web logs (blogs) are common features of Social Networking sites. Note: These sites may contain offensive material in the community-created content. Sites in this category are also referred to as "virtual communities" or "online communities". This category does not include more narrowly focused sites, like those that specifically match descriptions for Personals/Dating sites or Business sites.
Multimedia	
Audio/Video Clips	This category includes pages that provide streams or downloads of audio or video clips which are typically less than 15 minutes or less in length. Also includes sites that provide downloaders and players for audio and video clips.
Media Sharing	This category includes pages that allow sharing of media (e.g., photo sharing) and have a low risk of including objectionable content such as adult or pornographic material.
Radio/Audio Streams	This category includes pages that provide streams or downloads of radio, music, or other audio content-typically more than 15 minutes in length.
TV/Video Streams	This category includes pages that provide streams or downloads of television, movie, Webcam, or other video content-typically more than 15 minutes in length.
Communication	
Chat/Instant Messaging	This category includes pages that provide chat or instant messaging capabilities or client downloads.
Online Meetings	This category includes pages that facilitate online meetings or provide online meeting, conferencing or training services.
Email	This category includes pages offering web-based email services, such as online email reading, e-cards, and mailing list services.
Newsgroups/Forums	This category includes pages that primarily offer access to newsgroups, messaging or bulletin board systems, or group blogs where participants can post comments, hold discussions, or seek opinions or expertise on a variety of topics.
Internet Telephony	This category includes pages that facilitate Internet telephony or provide Internet telephony services such as voice over IP (VoIP).
Health Related	

Table 142 Configuration > Anti-X > Content Filter > Filter Profile > Add (continued)

LABEL	DESCRIPTION
Abortion	This category includes pages that provide information or arguments in favor of or against abortion, describe abortion procedures, offer help in obtaining or avoiding abortion, or provide information on the effects, or lack thereof, of abortion.
Restaurants/Dining/ Food	This category includes pages that list, review, discuss, advertise and promote food, catering, dining services, cooking and recipes.
Alcohol	Sites that promote, offer for sale, glorify, review, or in any way advocate the use or creation of alcoholic beverages, including but not limited to beer, wine, and hard liquors. Pages that sell alcohol as a subset of other products such as restaurants or grocery stores are not included.
Tobacco	This category includes pages that promote, offer for sale, glorify, review, or in any way advocate the use or creation of tobacco or tobacco related products including but not limited to cigarettes, pipes, cigars and chewing tobacco. Pages that sell tobacco as a subset of other products such as grocery stores are not included.
Health	This category includes pages that provide advice and information on general health such as fitness and well-being, personal health or medical services, drugs, alternative and complimentary therapies, medical information about ailments, dentistry, optometry, general psychiatry, self-help, and support organizations dedicated to a disease or condition.
Leisure	
Art/Culture	This category includes pages that nurture and promote cultural understanding of fine art including but not limited to sculpture, paintings and other visual art forms, literature, music, dance, ballet, and performance art and the venues or foundations that support, foster or house them such as museums, galleries, symphonies and the like. Sites that provide a learning environment or cultural awareness outside of the strictures of formalized education such as museums and planetariums are included under this heading.
Entertainment	This category includes pages that provide information on or promote mass entertainment media including but not limited to film, film trailers, television, home entertainment, music, comics, entertainment-oriented periodicals, reviews, interviews, fan clubs, and celebrity gossip. Also includes wedding or other photography sites of a non-adult nature.
For Kids	This category includes pages designed specifically for children.
Games	This category includes pages that provide information and support game playing or downloading, video games, computer games, electronic games, tips, and advice on games or how to obtain cheat codes. It also includes pages dedicated to selling board games as well as journals and magazines dedicated to game playing. It includes pages that support or host online sweepstakes and giveaways.

Table 142 Configuration > Anti-X > Content Filter > Filter Profile > Add (continued)

LABEL	DESCRIPTION
Humor/Jokes	This category includes pages that primarily focus on comedy, jokes, fun, etc. This may include pages containing jokes of adult or mature nature. Pages containing humorous Adult/Mature content also have an Adult/Mature category rating.
Sports/Recreation	This category includes pages that promote or provide information about spectator sports, recreational activities, or hobbies. This does not include pages that discuss or promote gardening, collecting, board games, scrapbooking, quilting, etc.
Commerce	
Brokerage/Trading	This category includes pages that provide or advertise trading of securities and management of investment assets (online or offline). It also includes insurance pages, as well as pages that offer financial investment strategies, quotes, and news.
Business/Economy	This category includes pages devoted to business firms, business information, economics, marketing, business management and entrepreneurship. This does not include pages that perform services that are defined in another category (such as Information Technology companies, or companies that sell travel services).
Financial Services	This category includes pages that provide or advertise banking services (online or offline) or other types of financial information, such as loans. It does not include pages that offer market information, brokerage or trading services.
Job Search/Careers	This category includes pages that provide assistance in finding employment, and tools for locating prospective employers.
Real Estate	This category includes pages that provide information on renting, buying, or selling real estate or properties.
Auctions	This category includes pages that support the offering and purchasing of goods between individuals. This does not include classified advertisements.
Shopping	This category includes pages that provide or advertise the means to obtain goods or services. It does not include pages that can be classified in other categories (such as vehicles or weapons).
Travel	This category includes pages that promote or provide opportunity for travel planning, including finding and making travel reservations, vehicle rentals, descriptions of travel destinations, or promotions for hotels or casinos.
Vehicles	This category includes pages that provide information on or promote vehicles, boats, or aircraft, including pages that support online purchase of vehicles or parts.
Web Advertisements	This category includes pages that provide online advertisements or banners. This does not include advertising servers that serve adult-oriented advertisements.
Technology	
Computers/Internet	This category includes pages that sponsor or provide information on computers, technology, the Internet and technology-related organizations and companies.

Table 142 Configuration > Anti-X > Content Filter > Filter Profile > Add (continued)

LABEL	DESCRIPTION
Content Servers	This category includes servers that provide commercial hosting for a variety of content such as images and media files. These types of servers are typically used in conjunction with other web servers to optimize content retrieval speeds.
Non Viewable	This category includes servers with non-malicious, non-offensive content or resources used by applications, but not directly viewable by web browsers. It includes but is not limited to Web analytics sites (such as visitor tracking and ranking sites) and content filtering systems.
Web Hosting	This category includes pages of organizations that provide top-level domain pages, as well as web communities or hosting services.
Web Applications	This category includes pages with interactive, Web-based office/business applications. It excludes email, chat/IM or other sites that have a specific content category.
Information Related	
Education	This category includes pages that offer educational information, distance learning and trade school information or programs. It also includes pages that are sponsored by schools, educational facilities, faculty, or alumni groups.
News/Media	This category includes pages that primarily report information or comments on current events or contemporary issues of the day. It also includes radio stations and magazines. It does not include pages that can be rated in other categories.
Reference	This category includes pages containing personal, professional, or educational reference, including online dictionaries, maps, census, almanacs, library catalogues, genealogy-related pages and scientific information.
Search Engines/ Portals	This category includes pages that support searching the Internet, indices, and directories.
Translation	This category includes pages that allow translation of text (words, phrases, web pages, between various languages) or that can be used to identify a language.
Test Web Site Category	
URL to test	You can check which category a web page belongs to. Enter a web site URL in the text box.
Test Against Local Cache	Click this button to see the category recorded in the ZyWALL's content filtering database for the web page you specified (if the database has an entry for it).
Test Against Content Filter Category Server	Click this button to see the category recorded in the external content filter server's database for the web page you specified.
OK	Click OK to save your changes back to the ZyWALL.
Cancel	Click Cancel to exit this screen without saving your changes.

30.5.1 Content Filter Blocked and Warning Messages

These are the content filtering warning messages:

Table 143 Content Filter Warning Messages

CASE	WARNING MESSAGE
Safe category	The website access is restricted. Please contact with administrator. (matched category) (If you feel this site is improperly categorized, click here to double check the rating and see more details.)
Spyware/ Malware	This site contains malicious code or harmful content that could be downloaded to your computer without your consent.
Phishing	This site may be a forgery or imitation of another website, designed to trick users into sharing personal or financial information.
Proxy Avoidance	This site provides information on how to bypass proxy server features or gain access to URLs in any way that bypasses the proxy server.

30.6 Content Filter Customization Screen

Click **Configuration > Anti-X > Content Filter > Filter Profile > Add or Edit > Customization** to open the **Customization** screen. You can create a list of good (allowed) web site addresses and a list of bad (blocked) web site addresses. You can also block web sites based on whether the web site's address contains a

keyword. Use this screen to add or remove specific sites or keywords from the filter list.

Figure 301 Configuration > Anti-X > Content Filter > Filter Profile > Customization

The screenshot shows the 'Add Filter Profile' window with the 'Custom Service' tab selected. It contains several sections for configuration:

- General Settings:** Includes a 'Name' field with a red error icon, and checkboxes for 'Enable Custom Service' and 'Allow web traffic for trusted web sites only'.
- Restricted Web Features:** Includes checkboxes for 'Block: ActiveX', 'Java', 'Cookies', and 'Web Proxy', and a checkbox for 'Allow Java/ActiveX/Cookies/Web proxy to trusted web sites'.
- Trusted Web Sites:** A table with 'Add', 'Edit', and 'Remove' buttons. The table is empty, showing 'Page 1 of 1' and 'Show 50 items'.
- Forbidden Web Sites:** A table with 'Add', 'Edit', and 'Remove' buttons. The table is empty, showing 'Page 1 of 1' and 'Show 50 items'.
- Blocked URL Keywords:** A table with 'Add', 'Edit', and 'Remove' buttons. The table is empty, showing 'Page 1 of 1' and 'Show 50 items'.

Buttons for 'OK' and 'Cancel' are located at the bottom right of the window.

The following table describes the labels in this screen.

Table 144 Configuration > Anti-X > Content Filter > Filter Profile > Customization

LABEL	DESCRIPTION
Name	Enter a descriptive name for this content filtering profile name. You may use 1-31 alphanumeric characters, underscores(_), or dashes (-), but the first character cannot be a number. This value is case-sensitive.
Enable Custom Service	Select this check box to allow trusted web sites and block forbidden web sites. Content filter list customization may be enabled and disabled without re-entering these site names.
Allow Web traffic for trusted web sites only	When this box is selected, the ZyWALL blocks Web access to sites that are not on the Trusted Web Sites list. If they are chosen carefully, this is the most effective way to block objectionable material.
Restricted Web Features	Select the check box(es) to restrict a feature. When you download a page containing a restricted feature, that part of the web page will appear blank or grayed out.

Table 144 Configuration > Anti-X > Content Filter > Filter Profile > Customization

LABEL	DESCRIPTION
Block ActiveX	ActiveX is a tool for building dynamic and active web pages and distributed object applications. When you visit an ActiveX web site, ActiveX controls are downloaded to your browser, where they remain in case you visit the site again.
Java	Java is a programming language and development environment for building downloadable Web components or Internet and intranet business applications of all kinds.
Cookies	Cookies are files stored on a computer's hard drive. Some web servers use them to track usage and provide service based on ID.
Web Proxy	A server that acts as an intermediary between a user and the Internet to provide security, administrative control, and caching service. When a proxy server is located on the WAN it is possible for LAN users to circumvent content filtering by pointing to this proxy server.
Allow Java/ActiveX/ Cookies/Web proxy to trusted web sites	When this box is selected, the ZyWALL will permit Java, ActiveX and Cookies from sites on the Trusted Web Sites list to the LAN. In certain cases, it may be desirable to allow Java, ActiveX or Cookies from sites that are known and trusted.
Trusted Web Sites	These are sites that you want to allow access to, regardless of their content rating, can be allowed by adding them to this list.
Add	Click this to create a new entry.
Edit	Select an entry and click this to be able to modify it.
Remove	Select an entry and click this to delete it.
Trusted Web Site	This column displays the trusted web sites already added. Enter host names such as www.good-site.com into this text field. Do not enter the complete URL of the site – that is, do not include "http://". All subdomains are allowed. For example, entering "zyxel.com" also allows "www.zyxel.com", "partner.zyxel.com", "press.zyxel.com", and so on. You can also enter just a top level domain. For example, enter .com to allow all .com domains. Use up to 127 characters (0-9a-z-). The casing does not matter.
Forbidden Web Site List	Sites that you want to block access to, regardless of their content rating, can be allowed by adding them to this list.
Add	Click this to create a new entry.
Edit	Select an entry and click this to be able to modify it.
Remove	Select an entry and click this to delete it.

Table 144 Configuration > Anti-X > Content Filter > Filter Profile > Customization

LABEL	DESCRIPTION
Forbidden Web Sites	<p>This list displays the forbidden web sites already added.</p> <p>Enter host names such as www.bad-site.com into this text field. Do not enter the complete URL of the site – that is, do not include “http://”. All subdomains are also blocked. For example, entering “bad-site.com” also blocks “www.bad-site.com”, “partner.bad-site.com”, “press.bad-site.com”, and do on. You can also enter just a top level domain. For example, enter .com to block all .com domains.</p> <p>Use up to 127 characters (0-9a-z-). The casing does not matter.</p>
Blocked URL Keywords	This section allows you to block Web sites with URLs that contain certain keywords in the domain name or IP address.
Add	Click this to create a new entry.
Edit	Select an entry and click this to be able to modify it.
Remove	Select an entry and click this to delete it.
Blocked URL Keywords	<p>This list displays the keywords already added.</p> <p>Enter a keyword or a numerical IP address to block. You can also enter a numerical IP address.</p> <p>Use up to 63 case-insensitive characters (0-9a-zA-Z;/?:@&=+\$\._!~*()%). For example enter Bad_Site to block access to any web page that includes the exact phrase Bad_Site. This does not block access to web pages that only include part of the phrase (such as Bad for example).</p>
OK	Click OK to save your changes back to the ZyWALL.
Cancel	Click Cancel to exit this screen without saving your changes.

30.7 Content Filter Technical Reference

This section provides content filtering background information.

External Content Filter Server Lookup Procedure

The content filter lookup process is described below.

Figure 302 Content Filter Lookup Procedure

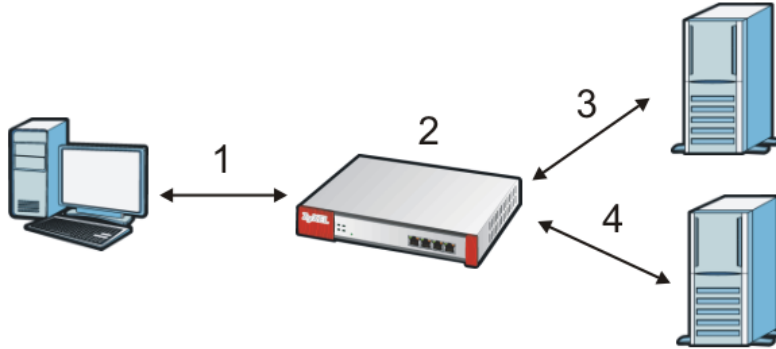

- 1 A computer behind the ZyWALL tries to access a web site.
- 2 The ZyWALL looks up the web site in its cache. If an attempt to access the web site was made in the past, a record of that web site's category will be in the ZyWALL's cache. The ZyWALL blocks, blocks and logs or just logs the request based on your configuration.
- 3 Use the **Content Filter Cache** screen to configure how long a web site address remains in the cache as well as view those web site addresses (see [Section 9.15 on page 202](#)). All of the web site address records are also cleared from the local cache when the ZyWALL restarts.
- 4 If the ZyWALL has no record of the web site, it queries the external content filter database and simultaneously sends the request to the web server.
- 5 The external content filter server sends the category information back to the ZyWALL, which then blocks and/or logs access to the web site based on the settings in the content filter profile. The web site's address and category are then stored in the ZyWALL's content filter cache.

Content Filter Reports

31.1 Overview

You can view content filtering reports after you have activated the category-based content filtering subscription service.

See [Section 10.1 on page 211](#) on how to create a myZyXEL.com account, register your device and activate the subscription services.

31.2 Viewing Content Filter Reports

Content filtering reports are generated statistics and charts of access attempts to web sites belonging to the categories you selected in your device content filter screen.

You need to register your iCard before you can view content filtering reports.

Alternatively, you can also view content filtering reports during the free trial (up to 30 days).

- 1 Go to <http://www.myZyXEL.com>.

- 2 Fill in your myZyXEL.com account information and click **Login**.

Figure 303 myZyXEL.com: Login

myZyXEL.com

WELCOME

- > New Account
- > Language
- > Registered?
- > FAQ
- > Support Note

LOGIN CONTACT US

Login/

Welcome to myZyXEL.com

What's myZyXEL.com? [Anti-Spam trial service stop announcement](#)

myZyXEL.com provides an easy-to-use service management platform where you can manage your ZyXEL product registrations and services using your personal account.

The ZyXEL products which can be registered at myZyXEL.com are as follows:

ZyWALL Series:	which support Content Filter, Anti-Virus, IDP, Anti-Spam and VPN
P662H series and P662HW series:	which support Anti-Virus and Content Access Control
HS100/HS100W	which support Content Filter
Vantage series	which include Vantage CNM, Vantage Report and Vantage Access
NetAtlas Access EMS	which support device management

Please register your account at myZyXEL.com first.

Log In

Username: ; [Forget User Name / Password? Click here](#)

Password:

Remember Username:

Spottlights

mySecurity Zone

ZyXEL | [Privacy Statement](#) Version 3.2.02.60.01b1 (C) Copyright 1995-2008 by ZyXEL Communications Corp.

- 3 A welcome screen displays. Click your ZyWALL's model name and/or MAC address under **Registered ZyXEL Products** (the ZyWALL 70 is shown as an example here). You can change the descriptive name for your ZyWALL using the **Rename** button in the **Service Management** screen (see [Figure 305 on page 516](#)).

Figure 304 myZyXEL.com: Welcome

myZyXEL.com

Welcome | My Account | My Product | Download Center |

WELCOME

Welcome /

Welcome

Welcome!

You have logged in myZyXEL.com for 668 times.

> Last Viewed

- * IP: 172.25.21.18
- * Viewed Date: 2009-03-05
- * Viewed time: 17:32:19(GMT+8:00)Beijing

Registered ZyXEL Products

To register product, [Click here](#)

Friendly Name	Model	Serial Number	Authentication Code / MAC Address
IPPBX X6004-00FFFF100029	IPPBX X6004	FFFF100029	00FFFF100029
IPPBX X6004-00FFFF100028	IPPBX X6004	FFFF100028	00FFFF100028
IPPBX X6004-00FFFF100027	IPPBX X6004	FFFF100027	00FFFF100027
IPPBX X6004-00FFFF100026	IPPBX X6004	FFFF100026	00FFFF100026
ZYWALL 70-0000AA778821	ZYWALL 70	AAAA778821	0000AA778821

More

Spotlights

mySecurity Zone

- In the **Service Management** screen click **Content Filter** in the **Service Name** column to open the content filter reports screens.

Figure 305 myZyXEL.com: Service Management

My Products / Service Activation

Service Management

Product Information

ZYWALL 70-0000AA778821

Serial Number: AAAA778821
 Products: ZYWALL 70
 Authentication Code / MAC: 0000AA778821
 Address:
 Activation Key: N/A

Manage Product

Manage this product's registration by clicking on the appropriate buttons below

> ZYWALL 70-0000AA778821

Available Service List

To enable your service(s), please click "Activate" shown below to enter your license key(s).

	Service Name	Service Activation	Service Type	Status	Expiration Date	Remark
1	Content Filter	Upgrade	Standard	Installed	2010-04-06	-
2	Anti-Spam Service	Activate				-
3	IDP/Anti-Virus Service	Activate				-

- In the **Web Filter Home** screen, click the **Reports** tab.

Figure 306 Content Filter Reports Main Screen

ZyXEL Powered By **Blue Coat** Technical Support

Web Filter Home **Reports**

Home

Web Filter Home

Welcome

You're protected by Blue Coat Web Filtering. Web Filtering provides you the ability to control what web sites can be accessed on your home or business PC. Blue Coat Web Filter allows you to modify blocked categories and view reports of Internet activity.

REPORTS:

Track Internet activity by viewing user reports, including site violations.

[Web Filter Home](#) | [Reports](#) | [Logout](#)

- 6 Select items under **Global Reports** to view the corresponding reports.

Figure 307 Content Filter Reports: Report Home

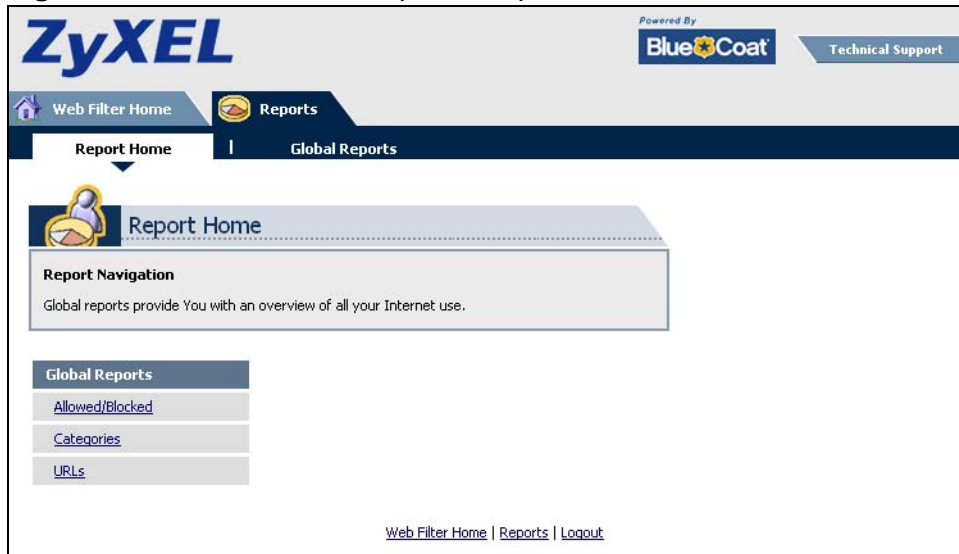

- 7 Select a time period in the **Date Range** field, either **Allowed** or **Blocked** in the **Action Taken** field and a category (or enter the user name if you want to view single user reports) and click **Run Report**. The screens vary according to the report type you selected in the **Report Home** screen.

- 8 A chart and/or list of requested web site categories display in the lower half of the screen.

Figure 308 Global Report Screen Example

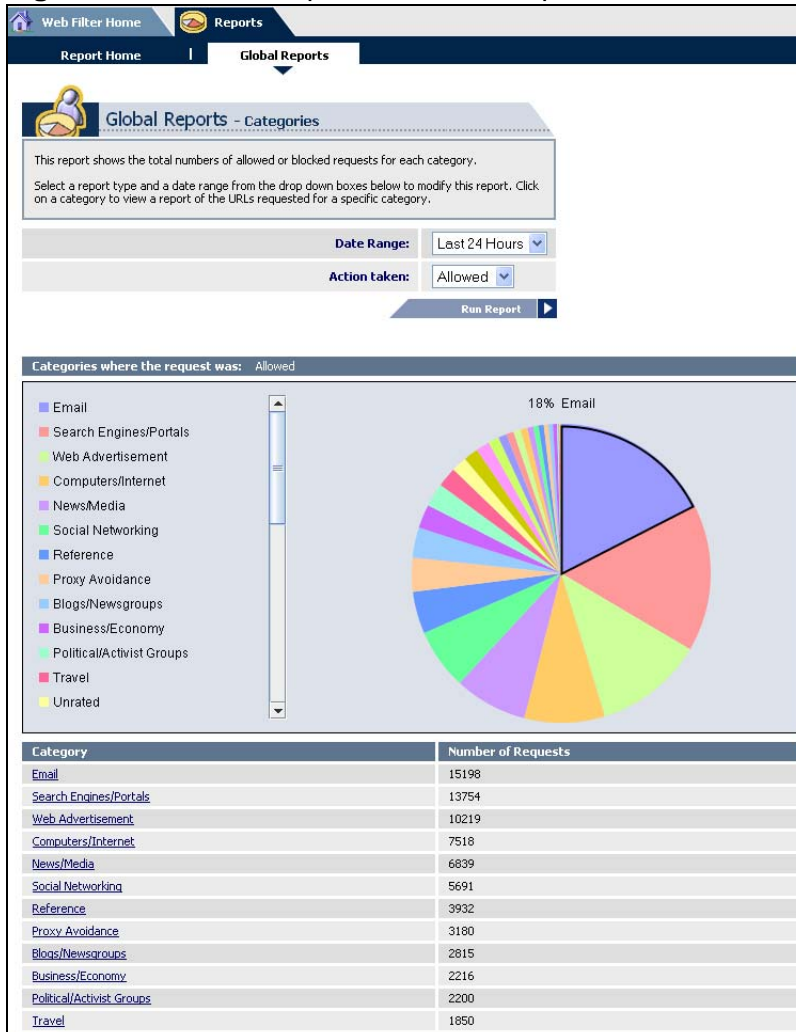

- 9 You can click a category in the **Categories** report or click **URLs** in the **Report Home** screen to see the URLs that were requested.

Figure 309 Requested URLs Example

The screenshot shows the ZyXEL Web Filter Reports interface. At the top, there are logos for ZyXEL and Blue Coat, along with a 'Technical Support' link. The navigation bar includes 'Web Filter Home' and 'Reports'. Under 'Reports', there are tabs for 'Report Home' and 'Global Reports'. The main content area is titled 'Global Reports - URLs' and contains a description: 'This report displays allowed or blocked URLs requested within a specific category.' Below this are three filter sections: 'Date Range' set to 'Last 24 Hours', 'Action taken' set to 'Allowed', and 'Category' set to 'Email'. A 'Run Report' button is located at the bottom right of the filter section. Below the filters, a table titled 'URLs Requested for category: Email' displays the following data:

Item #	URL	Number of Requests	Open Web Page
1	www.mail.yahoo.com/	10	
2	mail.yahoo.com/	10	
3	mail.google.com/ajstam.com.my/	10	
4	mail.google.com/mail/	9	
5	mail.google.com/mail/?ui=2&view=bsp&ver=1qygpcurkovy	9	
6	uk.mg41.mail.yahoo.com/ws/mail/v1/formrpc?m=GetDisplayMessage&appid=YahooMailRC&...	9	
7	us.mg1.mail.yahoo.com/ws/mail/v1/formrpc?m=ListMessages&appid=YahooMailRC&fid=In...	8	
8	mail.yahoo.com/?intl=us	8	
9	mail.google.com/mail/?shva=1	8	
10	mail.google.com/mail/?ui=2&ik=3f43ea5532&view=au&rt=j	8	
11	mail.google.com/mail/?logout&hl=en	8	
12	mail.google.com/mail/?view=page&name=browser&ver=zpwhtygjnrz	8	
13	www.gmail.com/	7	
14	filetransferenabled.mail.google.com/images/cleardot.gif	7	
15	mail.google.com/mail/images/cleardot.gif	7	
16	mail.google.com/mail/?ui=2&view=js&name=js&ver=v0lxBnHNwXQ&am=X7V4pcX3cBGIBfX0f...	7	
17	mail.google.com/mail/?view=sjs&name=wh&ver=yqaglnk9n79	7	
18	mail.google.com/ajstam.com.my/?view=ca&file=2	7	
19	mail.google.com/ajstam.com.my/?view=sjs&name=wh&ver=yqaglnk9n79	7	
20	mail.yimg.com/aj/us/pim/dclient/img/spacer_1.gif	7	
21	us.mg2.mail.yahoo.com/ws/mail/v1/formrpc?m=GetDisplayMessage&appid=YahooMailRC&f...	6	
22	mail.google.com/mail/?hl=en&tab=wm	6	
23	mail.google.com/mail/?view=ca&file=2	6	
24	mail.google.com/mail/?ui=2&view=jsm&name=ld%2Cml&ver=v0lxBnHNwXQ&am=X7V4pcX3cBGI...	6	
25	mail.google.com/ajstam.com.my/?ui=2&ik=543adc39f9&view=t0&start=0&num=70&auto=1&...	6	

Anti-Spam

32.1 Overview

The anti-spam feature can mark or discard spam (unsolicited commercial or junk e-mail). Use the white list to identify legitimate e-mail. Use the black list to identify spam e-mail. The ZyWALL can also check e-mail against a DNS black list (DNSBL) of IP addresses of servers that are suspected of being used by spammers.

32.1.1 What You Can Do in this Chapter

- Use the **General** screens ([Section 32.3 on page 523](#)) to turn anti-spam on or off and manage anti-spam policies.
- Use the **Black/White List** screens ([Section 32.4 on page 527](#)) to set up a black list to identify spam and a white list to identify legitimate e-mail.
- Use the **DNSBL** screens ([Section 32.6 on page 532](#)) to have the ZyWALL check e-mail against DNS Black Lists.

32.1.2 What You Need to Know

White list

Configure white list entries to identify legitimate e-mail. The white list entries have the ZyWALL classify any e-mail that is from a specified sender or uses a specified header field and header value as being legitimate (see [E-mail Headers on page 522](#) for more on mail headers). The anti-spam feature checks an e-mail against the white list entries before doing any other anti-spam checking. If the e-mail matches a white list entry, the ZyWALL classifies the e-mail as legitimate and does not perform any more anti-spam checking on that individual e-mail. A properly configured white list helps keep important e-mail from being incorrectly classified as spam. The white list can also increase the ZyWALL's anti-spam speed and efficiency by not having the ZyWALL perform the full anti-spam checking process on legitimate e-mail.

Black List

Configure black list entries to identify spam. The black list entries have the ZyWALL classify any e-mail that is from or forwarded by a specified IP address or uses a specified header field and header value as being spam. If an e-mail does not match any of the white list entries, the ZyWALL checks it against the black list entries. The ZyWALL classifies an e-mail that matches a black list entry as spam and immediately takes the configured action for dealing with spam. If an e-mail matches a blacklist entry, the ZyWALL does not perform any more anti-spam checking on that individual e-mail. A properly configured black list helps catch spam e-mail and increases the ZyWALL's anti-spam speed and efficiency.

SMTP and POP3

Simple Mail Transfer Protocol (SMTP) is the Internet's message transport standard. It controls the sending of e-mail messages between servers. E-mail clients (also called e-mail applications) then use mail server protocols such as POP (Post Office Protocol) or IMAP (Internet Message Access Protocol) to retrieve e-mail. E-mail clients also generally use SMTP to send messages to a mail server. The older POP2 requires SMTP for sending messages while the newer POP3 can be used with or without it. This is why many e-mail applications require you to specify both the SMTP server and the POP or IMAP server (even though they may actually be the same server).

The ZyWALL's anti-spam feature checks SMTP (TCP port 25) and POP3 (TCP port 110) e-mails. The anti-spam feature does not check (or act upon) e-mails that use other protocols (such as IMAP) or other port numbers.

E-mail Headers

Every email has a header and a body. The header is structured into fields and includes the addresses of the recipient and sender, the subject, and other information about the e-mail and its journey. The body is the actual message text and any attachments. You can have the ZyWALL check for specific header fields with specific values.

E-mail programs usually only show you the To:, From:, Subject:, and Date: header fields but there are others such as Received: and Content-Type:. To see all of an e-mail's header, you can select an e-mail in your e-mail program and look at its properties or details. For example, in Microsoft's Outlook Express, select a mail and click **File > Properties > Details**. This displays the e-mail's header. Click **Message Source** to see the source for the entire mail including both the header and the body.

E-mail Header Buffer Size

The ZyWALL has a 5 K buffer for an individual e-mail header. If an e-mail's header is longer than 5 K, the ZyWALL only checks up to the first 5 K.

DNSBL

A DNS Black List (DNSBL) is a server that hosts a list of IP addresses known or suspected of having sent or forwarded spam. A DNSBL is also known as a DNS spam blocking list. The ZyWALL can check the routing addresses of e-mail against DNSBLs and classify an e-mail as spam if it was sent or forwarded by a computer with an IP address in the DNSBL.

Finding Out More

See [Section 32.7 on page 534](#) for more background information on anti-spam.

32.2 Before You Begin

Configure your zones before you configure anti-spam.

32.3 The Anti-Spam General Screen

Click **Configuration > Anti-X > Anti-Spam** to open the **Anti-Spam General** screen. Use this screen to turn the anti-spam feature on or off and manage anti-

spam policies. You can also select the action the ZyWALL takes when the mail sessions threshold is reached.

Figure 310 Configuration > Anti-X > Anti-Spam > General

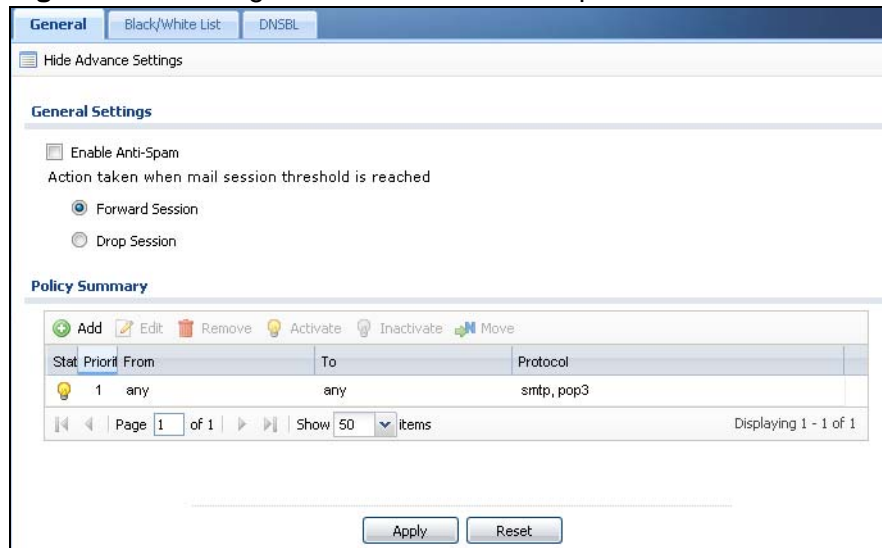

The following table describes the labels in this screen.

Table 145 Configuration > Anti-X > Anti-Spam > General

LABEL	DESCRIPTION
Show Advance Settings / Hide Advance Settings	Click this button to display a greater or lesser number of configuration fields.
General Settings	
Enable Anti-Spam	Select this check box to check SMTP (TCP port 25) and POP3 (TCP port 110) traffic for spam e-mail.
Action taken when mail sessions threshold is reached	<p>An e-mail session is when an e-mail client and e-mail server (or two e-mail servers) connect through the ZyWALL. Select how to handle concurrent e-mail sessions that exceed the maximum number of concurrent e-mail sessions that the anti-spam feature can handle. See the chapter of product specifications for the threshold.</p> <p>Select Forward Session to have the ZyWALL allow the excess e-mail sessions without any spam filtering.</p> <p>Select Drop Session to have the ZyWALL drop mail connections to stop the excess e-mail sessions. The e-mail client or server will have to re-attempt to send or receive e-mail later when the number of e-mail sessions is under the threshold.</p>
Policy Summary	
Add	Click this to create a new entry. Select an entry and click Add to create a new entry after the selected entry.
Edit	Select an entry and click this to be able to modify it.

Table 145 Configuration > Anti-X > Anti-Spam > General

LABEL	DESCRIPTION
Remove	Select an entry and click this to delete it.
Activate	To turn on an entry, select it and click Activate .
Inactivate	To turn off an entry, select it and click Inactivate .
Move	To change an entry's position in the numbered list, select it and click Move to display a field to type a number for where you want to put that entry and press [ENTER] to move the entry to the number that you typed.
Status	The activate (light bulb) icon is lit when the entry is active and dimmed when the entry is inactive.
Priority	This is the position of an anti-spam policy in the list. The ordering of your anti-spam policies is important as the ZyWALL applies them in sequence. Once traffic matches an anti-spam policy, the ZyWALL applies that policy and does not check the traffic against any more policies.
From	The anti-spam policy has the ZyWALL scan e-mail traffic that is coming from this zone and going to the To zone.
To	The anti-spam policy has the ZyWALL scan e-mail traffic that is going to this zone from the From zone.
Protocol	These are the protocols of traffic to scan for spam. SMTP applies to traffic using TCP port 25. POP3 applies to traffic using TCP port 110.
Apply	Click Apply to save your changes back to the ZyWALL.
Reset	Click Reset to return the screen to its last-saved settings.

32.3.1 The Anti-Spam Policy Add or Edit Screen

Click the **Add** or **Edit** icon in the **Configuration > Anti-X > Anti-Spam > General** screen to display the configuration screen as shown next. Use this screen to configure an anti-spam policy that controls what traffic direction of e-mail to

check, which e-mail protocols to scan, the scanning options, and the action to take on spam traffic.

Figure 311 Configuration > Anti-X > Anti-Spam > General > Add

The following table describes the labels in this screen.

Table 146 Configuration > Anti-X > Anti-Spam > General > Add

LABEL	DESCRIPTION
Enable Policy	Select this check box to have the ZyWALL apply this anti-spam policy to check e-mail traffic for spam.
Log	Select how the ZyWALL is to log the event when the DNSBL times out or an e-mail matches the white list, black list, or DNSBL. no: Do not create a log. log: Create a log on the ZyWALL. log alert: An alert is an e-mailed log for more serious events that may need more immediate attention. Select this option to have the ZyWALL send an alert.
From To	Select source and destination zones for traffic to scan for spam. The anti-spam policy has the ZyWALL scan traffic coming from the From zone and going to the To zone.
Protocols to Scan	Select which protocols of traffic to scan for spam. SMTP applies to traffic using TCP port 25. POP3 applies to traffic using TCP port 110.

Table 146 Configuration > Anti-X > Anti-Spam > General > Add (continued)

LABEL	DESCRIPTION
Check White List	Select this check box to check e-mail against the white list. The ZyWALL classifies e-mail that matches a white list entry as legitimate (not spam).
Check Black List	Select this check box to check e-mail against the black list. The ZyWALL classifies e-mail that matches a black list entry as spam.
Check DNSBL	Select this check box to check e-mail against the ZyWALL's configured DNSBL domains. The ZyWALL classifies e-mail that matches a DNS black list as spam.
Actions for Spam Mail	Use this section to set how the ZyWALL is to handle spam mail.
SMTP	Select how the ZyWALL is to handle spam SMTP mail. Select drop to discard spam SMTP mail. Select forward to allow spam SMTP mail to go through. Select forward with tag to add a spam tag to an SMTP spam mail's mail subject and send it on to the destination.
POP3	Select how the ZyWALL is to handle spam POP3 mail. Select forward to allow spam POP3 mail to go through. Select forward with tag to add a spam tag to an POP3 spam mail's mail subject and send it on to the destination.
OK	Click OK to save your changes.
Cancel	Click Cancel to exit this screen without saving your changes.

32.4 The Anti-Spam Black List Screen

Click **Configuration > Anti-X > Anti-Spam > Black /White List** to display the **Anti-Spam Black List** screen.

Configure the black list to identify spam e-mail. You can create black list entries based on the sender's or relay server's IP address or e-mail address. You can also create entries that check for particular e-mail header fields with specific values or

specific subject text. Click a column's heading cell to sort the table entries by that column's criteria. Click the heading cell again to reverse the sort order.

Figure 312 Configuration > Anti-X > Anti-Spam > Black/White List > Black List

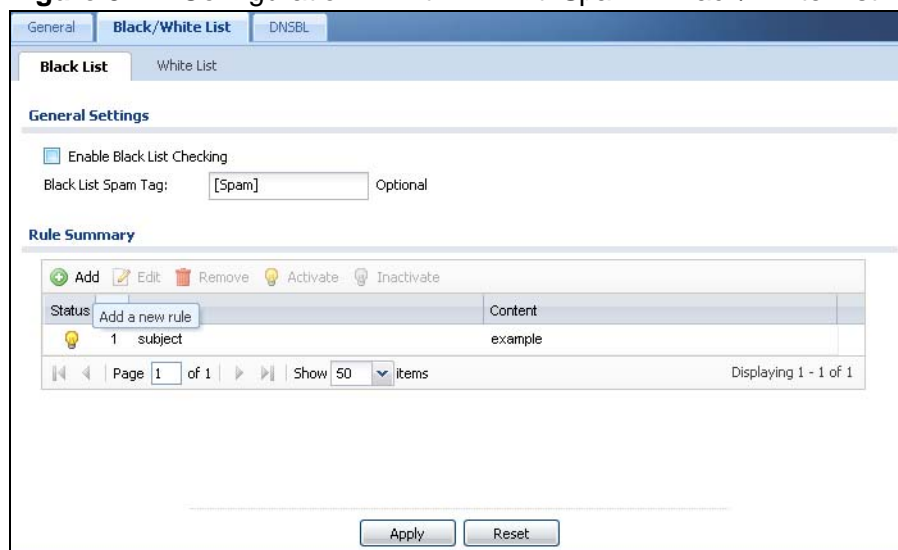

The following table describes the labels in this screen.

Table 147 Configuration > Anti-X > Anti-Spam > Black/White List > Black List

LABEL	DESCRIPTION
General Settings	
Enable Black List Checking	Select this check box to have the ZyWALL treat e-mail that matches (an active) black list entry as spam.
Black List Spam Tag	Enter a message or label (up to 15 ASCII characters) to add to the mail subject of e-mails that match the ZyWALL's spam black list.
Rule Summary	
Add	Click this to create a new entry.
Edit	Select an entry and click this to be able to modify it.
Remove	Select an entry and click this to delete it.
Activate	To turn on an entry, select it and click Activate .
Inactivate	To turn off an entry, select it and click Inactivate .
Status	The activate (light bulb) icon is lit when the entry is active and dimmed when the entry is inactive.
#	This is the entry's index number in the list.
Type	This field displays whether the entry is based on the e-mail's subject, source or relay IP address, source e-mail address, or header.
Content	This field displays the subject content, source or relay IP address, source e-mail address, or header value for which the entry checks.
Apply	Click Apply to save your changes back to the ZyWALL.
Reset	Click Reset to return the screen to its last-saved settings.

32.4.1 The Anti-Spam Black or White List Add/Edit Screen

In the anti-spam **Black List** or **White List** screen, click the **Add** icon or an **Edit** icon to display the following screen.

Use this screen to configure an anti-spam black list entry to identify spam e-mail. You can create entries based on specific subject text, or the sender's or relay's IP address or e-mail address. You can also create entries that check for particular header fields and values.

Figure 313 Configuration > Anti-X > Anti-Spam > Black/White List > Black List (or White List) > Add

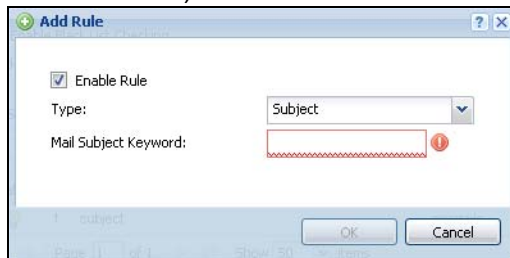

The following table describes the labels in this screen.

Table 148 Configuration > Anti-X > Anti-Spam > Black/White List > Black List (or White List) > Add

LABEL	DESCRIPTION
Enable Rule	Select this to have the ZyWALL use this entry as part of the black or white list. To actually use the entry, you must also turn on the use of the list in the corresponding list screen, enable the anti-spam feature in the anti-spam general screen, and configure an anti-spam policy to use the list.
Type	Use this field to base the entry on the e-mail's subject, source or relay IP address, source e-mail address, or header. Select Subject to have the ZyWALL check e-mail for specific content in the subject line. Select IP Address to have the ZyWALL check e-mail for a specific source or relay IP address. Select E-Mail Address to have the ZyWALL check e-mail for a specific source e-mail address or domain name. Select Mail Header to have the ZyWALL check e-mail for specific header fields and values. Configure black list header entries to check for e-mail from bulk mail programs or with content commonly used in spam. Configure white list header entries to allow certain header values that identify the e-mail as being from a trusted source.
Mail Subject Keyword	This field displays when you select the Subject type. Enter up to 63 ASCII characters of text to check for in e-mail headers. Spaces are not allowed, although you could substitute a question mark (?). See Section 32.4.2 on page 530 for more details.

Table 148 Configuration > Anti-X > Anti-Spam > Black/White List > Black List (or White List) > Add

LABEL	DESCRIPTION
Sender or Mail Relay IP Address	This field displays when you select the IP type. Enter an IP address in dotted decimal notation.
Netmask	This field displays when you select the IP type. Enter the subnet mask here, if applicable.
Sender E-Mail Address	This field displays when you select the E-Mail type. Enter a keyword (up to 63 ASCII characters). See Section 32.4.2 on page 530 for more details.
Mail Header Field Name	This field displays when you select the Mail Header type. Type the name part of an e-mail header (the part that comes before the colon). Use up to 63 ASCII characters. For example, if you want the entry to check the "Received:" header for a specific mail server's domain, enter "Received" here.
Field Value Keyword	This field displays when you select the Mail Header type. Type the value part of an e-mail header (the part that comes after the colon). Use up to 63 ASCII characters. For example, if you want the entry to check the "Received:" header for a specific mail server's domain, enter the mail server's domain here. See Section 32.4.2 on page 530 for more details.
OK	Click OK to save your changes.
Cancel	Click Cancel to exit this screen without saving your changes.

32.4.2 Regular Expressions in Black or White List Entries

The following applies for a black or white list entry based on an e-mail subject, e-mail address, or e-mail header value.

- Use a question mark (?) to let a single character vary. For example, use "a?c" (without the quotation marks) to specify abc, acc and so on.
- You can also use a wildcard (*). For example, if you configure *def.com, any e-mail address that ends in def.com matches. So "mail.def.com" matches.
- The wildcard can be anywhere in the text string and you can use more than one wildcard. You cannot use two wildcards side by side, there must be other characters between them.
- The ZyWALL checks the first header with the name you specified in the entry. So if the e-mail has more than one "Received" header, the ZyWALL checks the first one.

32.5 The Anti-Spam White List Screen

Click **Configuration > Anti-X > Anti-Spam > Black/White List** and then the **White List** tab to display the **Anti-Spam White List** screen.

Configure the white list to identify legitimate e-mail. You can create white list entries based on the sender's or relay's IP address or e-mail address. You can also create entries that check for particular header fields and values or specific subject text.

Figure 314 Configuration > Anti-X > Anti-Spam > Black/White List > White List

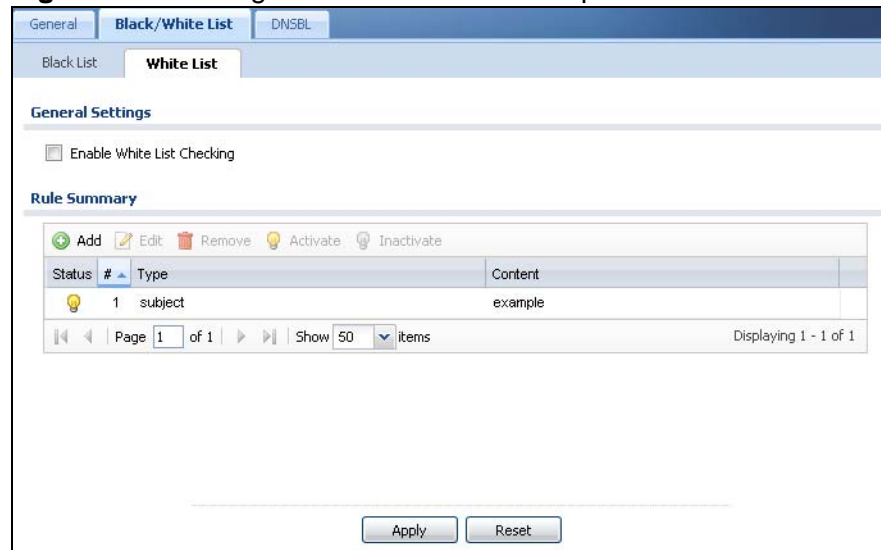

The following table describes the labels in this screen.

Table 149 Configuration > Anti-X > Anti-Spam > Black/White List > White List

LABEL	DESCRIPTION
General Settings	
Enable White List Checking	Select this check box to have the ZyWALL forward e-mail that matches (an active) white list entry without doing any more anti-spam checking on that individual e-mail.
Rule Summary	
Add	Click this to create a new entry. See Section 32.4.1 on page 529 for details.
Edit	Select an entry and click this to be able to modify it. See Section 32.4.1 on page 529 for details.
Remove	Select an entry and click this to delete it.
Activate	To turn on an entry, select it and click Activate .
Inactivate	To turn off an entry, select it and click Inactivate .
Status	The activate (light bulb) icon is lit when the entry is active and dimmed when the entry is inactive.
#	This is the entry's index number in the list.

Table 149 Configuration > Anti-X > Anti-Spam > Black/White List > White List

LABEL	DESCRIPTION
Type	This field displays whether the entry is based on the e-mail's subject, source or relay IP address, source e-mail address, or a header.
Content	This field displays the subject content, source or relay IP address, source e-mail address, or header value for which the entry checks.
OK	Click OK to save your changes.
Cancel	Click Cancel to exit this screen without saving your changes.

32.6 The DNSBL Screen

Click **Configuration > Anti-X > Anti-Spam > DNSBL** to display the anti-spam **DNSBL** screen. Use this screen to configure the ZyWALL to check the sender and relay IP addresses in e-mail headers against DNS (Domain Name Service)-based spam Black Lists (DNSBLs).

Figure 315 Configuration > Anti-X > Anti-Spam > DNSBL

The screenshot shows the DNSBL configuration interface. At the top, there are tabs for 'General', 'Black/White List', and 'DNSBL'. Below the tabs is a 'Hide Advance Settings' checkbox. The 'General Settings' section contains:

- Enable DNS Black List (DNSBL) Checking
- DNSBL Spam Tag: [Spam] Optional
- Max. IPs Checking Per Mail: 3 (1-5)
- IP Selection Per Mail: last N IPs

 The 'Query Timeout Setting' section contains:

- SMTP: forward with tag
- POPS: forward with tag
- Timeout Value: 5 (1-10 Seconds)
- Timeout Tag: [DNSBL Timeout] Optional

 The 'DNSBL Domain List' section features a table with columns 'Stat' and '# DNSBL Domain'. Below the table are navigation controls: Page 1 of 1, Show 50 items, and 'No data to display'. A note at the bottom states: 'Each mail relay and sender IP in mail header (under max. number) will be checked against the DNSBL domain servers listed and enabled above.' At the very bottom are 'Apply' and 'Reset' buttons.

The following table describes the labels in this screen.

Table 150 Configuration > Anti-X > Anti-Spam > DNSBL

LABEL	DESCRIPTION
Show Advance Settings / Hide Advance Settings	Click this button to display a greater or lesser number of configuration fields.
Enable DNS Black List (DNSBL) Checking	Select this to have the ZyWALL check the sender and relay IP addresses in e-mail headers against the DNSBL servers maintained by the DNSBL domains listed in the ZyWALL.
DNSBL Spam Tag	Enter a message or label (up to 15 ASCII characters) to add to the beginning of the mail subject of e-mails that have a sender or relay IP address in the header that matches a black list maintained by one of the DNSBL domains listed in the ZyWALL. This tag is only added if the anti-spam policy is configured to forward spam mail with a spam tag.
Max. IPs Checking Per Mail	Set the maximum number of sender and relay server IP addresses in the mail header to check against the DNSBL domain servers.
IP Selection Per Mail	Select first N IPs to have the ZyWALL start checking from the first IP address in the mail header. This is the IP of the sender or the first server that forwarded the mail. Select last N IPs to have the ZyWALL start checking from the last IP address in the mail header. This is the IP of the last server that forwarded the mail.
Query Timeout Setting	
SMTP	Select how the ZyWALL is to handle SMTP mail (mail going to an e-mail server) if the queries to the DNSBL domains time out. Select drop to discard SMTP mail. Select forward to allow SMTP mail to go through. Select forward with tag to add a DNSBL timeout tag to the mail subject of an SMTP mail and send it.
POP3	Select how the ZyWALL is to handle POP3 mail (mail coming to an e-mail client) if the queries to the DNSBL domains time out. Select forward to allow POP3 mail to go through. Select forward with tag to add a DNSBL timeout tag to the mail subject of an POP3 mail and send it.
Timeout Value	Set how long the ZyWALL waits for a reply from the DNSBL domains listed below. If there is no reply before this time period expires, the ZyWALL takes the action defined in the relevant Actions when Query Timeout field.
Timeout Tag	Enter a message or label (up to 15 ASCII characters) to add to the mail subject of e-mails that the ZyWALL forwards if queries to the DNSBL domains time out.
DNSBL Domain List	
Add	Click this to create a new entry.

Table 150 Configuration > Anti-X > Anti-Spam > DNSBL (continued)

LABEL	DESCRIPTION
Edit	Select an entry and click this to be able to modify it.
Remove	Select an entry and click this to delete it.
Activate	To turn on an entry, select it and click Activate .
Inactivate	To turn off an entry, select it and click Inactivate .
Status	The activate (light bulb) icon is lit when the entry is active and dimmed when the entry is inactive.
#	This is the entry's index number in the list.
DNSBL Domain	This is the name of a domain that maintains DNSBL servers. Enter the domain that is maintaining a DNSBL.
Apply	Click Apply to save your changes back to the ZyWALL.
Reset	Click Reset to return the screen to its last-saved settings.

32.7 Anti-Spam Technical Reference

Here is more detailed anti-spam information.

DNSBL

- The ZyWALL checks only public sender and relay IP addresses, it does not check private IP addresses.
- The ZyWALL sends a separate query (DNS lookup) for each sender or relay IP address in the e-mail's header to each of the ZyWALL's DNSBL domains at the same time.
- The DNSBL servers send replies as to whether or not each IP address matches an entry in their list. Each IP address has a separate reply.
- As long as the replies are indicating the IP addresses do not match entries on the DNSBL lists, the ZyWALL waits until it receives at least one reply for each IP address.
- If the ZyWALL receives a DNSBL reply that one of the IP addresses is in the DNSBL list, the ZyWALL immediately classifies the e-mail as spam and takes the anti-spam policy's configured action for spam. The ZyWALL does not wait for any more DNSBL replies.
- If the ZyWALL receives at least one non-spam reply for each of an e-mail's routing IP addresses, the ZyWALL immediately classifies the e-mail as legitimate and forwards it.
- Any further DNSBL replies that come after the ZyWALL classifies an e-mail as spam or legitimate have no effect.
- The ZyWALL records DNSBL responses for IP addresses in a cache for up to 72 hours. The ZyWALL checks an e-mail's sender and relay IP addresses against the cache first and only sends DNSBL queries for IP addresses that are not in the cache.

Here is an example of an e-mail classified as spam based on DNSBL replies.

Figure 316 DNSBL Spam Detection Example

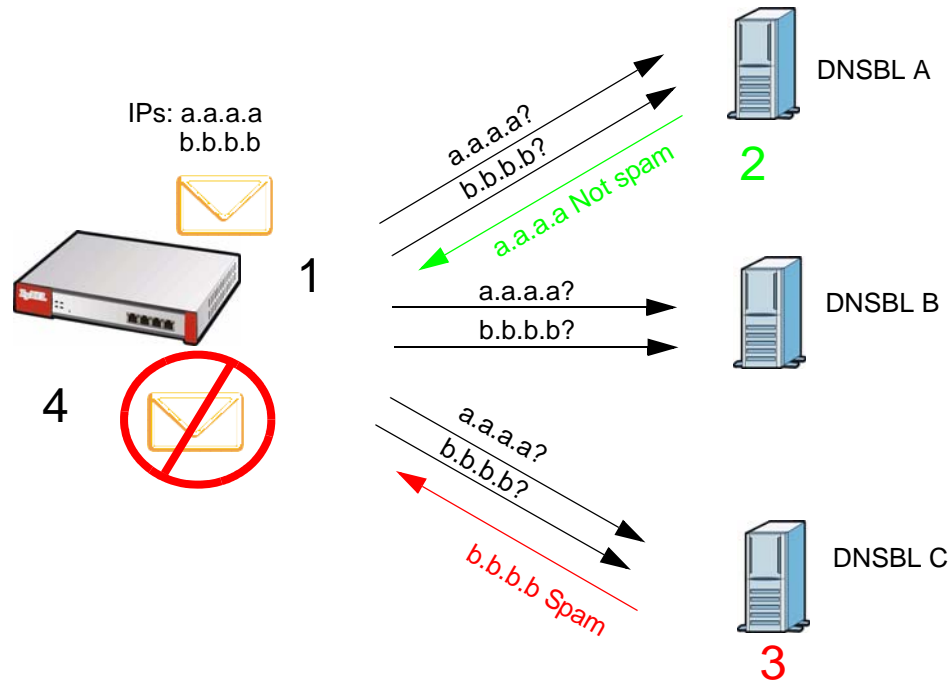

- 1 The ZyWALL receives an e-mail that was sent from IP address a.a.a.a and relayed by an e-mail server at IP address b.b.b.b. The ZyWALL sends a separate query to each of its DNSBL domains for IP address a.a.a.a. The ZyWALL sends another separate query to each of its DNSBL domains for IP address b.b.b.b.
- 2 DNSBL A replies that IP address a.a.a.a does not match any entries in its list (not spam).
- 3 DNSBL C replies that IP address b.b.b.b matches an entry in its list.
- 4 The ZyWALL immediately classifies the e-mail as spam and takes the action for spam that you defined in the anti-spam policy. In this example it was an SMTP mail and the defined action was to drop the mail. The ZyWALL does not wait for any more DNSBL replies.

Here is an example of an e-mail classified as legitimate based on DNSBL replies.

Figure 317 DNSBL Legitimate E-mail Detection Example

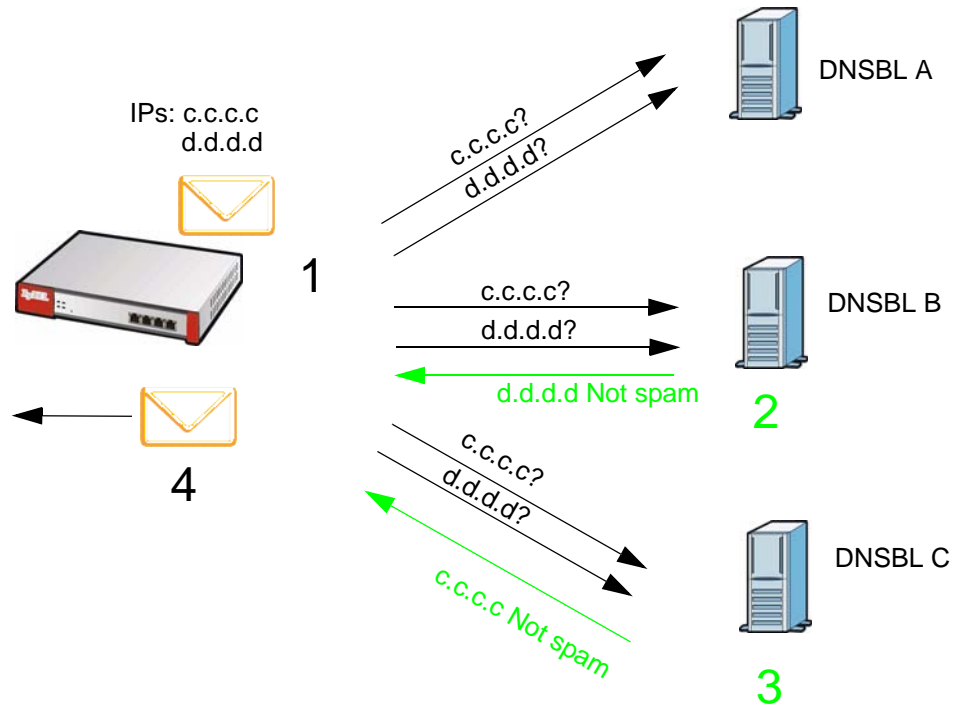

- 1 The ZyWALL receives an e-mail that was sent from IP address c.c.c.c and relayed by an e-mail server at IP address d.d.d.d. The ZyWALL sends a separate query to each of its DNSBL domains for IP address c.c.c.c. The ZyWALL sends another separate query to each of its DNSBL domains for IP address d.d.d.d.
- 2 DNSBL B replies that IP address d.d.d.d does not match any entries in its list (not spam).
- 3 DNSBL C replies that IP address c.c.c.c does not match any entries in its list (not spam).
- 4 Now that the ZyWALL has received at least one non-spam reply for each of the e-mail's routing IP addresses, the ZyWALL immediately classifies the e-mail as legitimate and forwards it. The ZyWALL does not wait for any more DNSBL replies.

If the ZyWALL receives conflicting DNSBL replies for an e-mail routing IP address, the ZyWALL classifies the e-mail as spam. Here is an example.

Figure 318 Conflicting DNSBL Replies Example

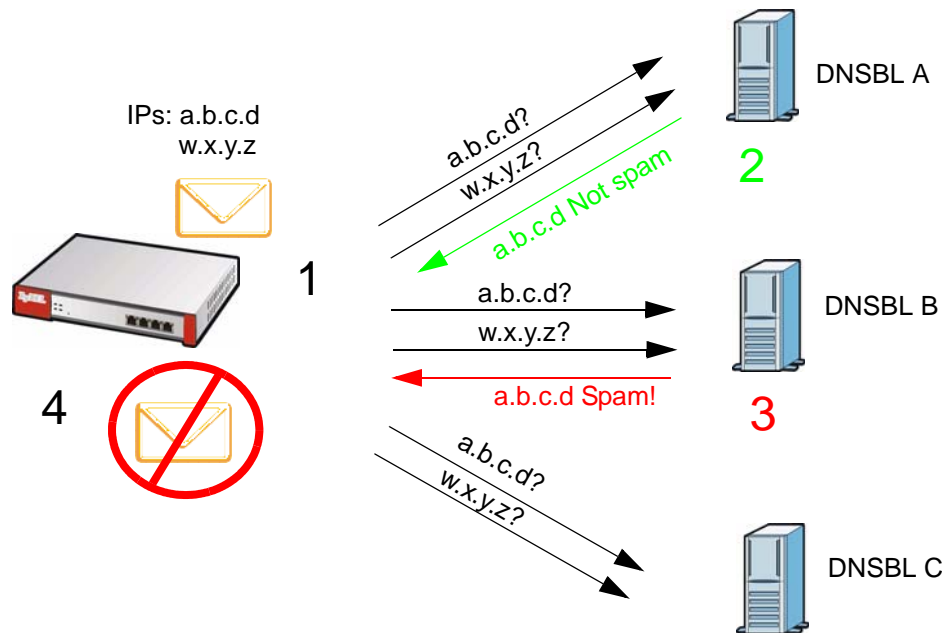

- 1 The ZyWALL receives an e-mail that was sent from IP address a.b.c.d and relayed by an e-mail server at IP address w.x.y.z. The ZyWALL sends a separate query to each of its DNSBL domains for IP address a.b.c.d. The ZyWALL sends another separate query to each of its DNSBL domains for IP address w.x.y.z.
- 2 DNSBL A replies that IP address a.b.c.d does not match any entries in its list (not spam).
- 3 While waiting for a DNSBL reply about IP address w.x.y.z, the ZyWALL receives a reply from DNSBL B saying IP address a.b.c.d is in its list.
- 4 The ZyWALL immediately classifies the e-mail as spam and takes the action for spam that you defined in the anti-spam policy. In this example it was an SMTP mail and the defined action was to drop the mail. The ZyWALL does not wait for any more DNSBL replies.

User/Group

33.1 Overview

This chapter describes how to set up user accounts, user groups, and user settings for the ZyWALL. You can also set up rules that control when users have to log in to the ZyWALL before the ZyWALL routes traffic for them.

33.1.1 What You Can Do in this Chapter

- The **User** screen (see [Section 33.2 on page 542](#)) provides a summary of all user accounts.
- The **Group** screen (see [Section 33.3 on page 545](#)) provides a summary of all user groups. In addition, this screen allows you to add, edit, and remove user groups. User groups may consist of access users and other user groups. You cannot put admin users in user groups
- The **Setting** screen (see [Section 33.4 on page 547](#)) controls default settings, login settings, lockout settings, and other user settings for the ZyWALL. You can also use this screen to specify when users must log in to the ZyWALL before it routes traffic for them.

33.1.2 What You Need To Know

User Account

A user account defines the privileges of a user logged into the ZyWALL. User accounts are used in firewall rules, in addition to controlling access to configuration and services in the ZyWALL.

User Types

These are the types of user accounts the ZyWALL uses.

Table 151 Types of User Accounts

TYPE	ABILITIES	LOGIN METHOD(S)
Admin Users		
admin	Change ZyWALL configuration (web, CLI)	WWW, TELNET, SSH, FTP, Console

Table 151 Types of User Accounts (continued)

TYPE	ABILITIES	LOGIN METHOD(S)
limited-admin	Look at ZyWALL configuration (web, CLI) Perform basic diagnostics (CLI)	WWW, TELNET, SSH, Console
Access Users		
user	Access network services Browse user-mode commands (CLI)	WWW, TELNET, SSH
guest	Access network services	WWW
ext-user	External user account	WWW
ext-group-user	External group user account	WWW

Note: The default **admin** account is always authenticated locally, regardless of the authentication method setting. (See [Chapter 37 on page 573](#) for more information about authentication methods.)

Ext-User Accounts

Set up an **ext-user** account if the user is authenticated by an external server and you want to set up specific policies for this user in the ZyWALL. If you do not want to set up policies for this user, you do not have to set up an **ext-user** account.

All **ext-user** users should be authenticated by an external server, such as AD, LDAP or RADIUS. If the ZyWALL tries to use the local database to authenticate an **ext-user**, the authentication attempt always fails. (This is related to AAA servers and authentication methods, which are discussed in [Chapter 37 on page 573](#) and [Chapter 38 on page 583](#), respectively.)

Note: If the ZyWALL tries to authenticate an **ext-user** using the local database, the attempt always fails.

Once an **ext-user** user has been authenticated, the ZyWALL tries to get the user type (see [Table 151 on page 539](#)) from the external server. If the external server does not have the information, the ZyWALL sets the user type for this session to **User**.

For the rest of the user attributes, such as reauthentication time, the ZyWALL checks the following places, in order.

- 1 User account in the remote server.
- 2 User account (Ext-User) in the ZyWALL.
- 3 Default user account for AD users (**ad-users**), LDAP users (**ldap-users**) or RADIUS users (**radius-users**) in the ZyWALL.

See [Setting up User Attributes in an External Server on page 553](#) for a list of attributes and how to set up the attributes in an external server.

Ext-Group-User Accounts

Ext-Group-User accounts work are similar to ext-user accounts but allow you to group users by the value of the group membership attribute configured for the AD or LDAP server. See [Section 37.2.1 on page 577](#) for more on the group membership attribute.

User Groups

User groups may consist of user accounts or other user groups. Use user groups when you want to create the same rule for several user accounts, instead of creating separate rules for each one.

Note: You cannot put access users and admin users in the same user group.

Note: You cannot put the default **admin** account into any user group.

The sequence of members in a user group is not important.

User Awareness

By default, users do not have to log into the ZyWALL to use the network services it provides. The ZyWALL automatically routes packets for everyone. If you want to restrict network services that certain users can use via the ZyWALL, you can require them to log in to the ZyWALL first. The ZyWALL is then 'aware' of the user who is logged in and you can create 'user-aware policies' that define what services they can use. See [Section 33.4.2 on page 552](#) for a user-aware login example.

Finding Out More

- See [Section 6.6.1 on page 104](#) for related information on these screens.
- See [Section 33.5 on page 553](#) for some information on users who use an external authentication server in order to log in.
- The ZyWALL supports TTLS using PAP so you can use the ZyWALL's local user database to authenticate users with WPA or WPA2 instead of needing an external RADIUS server. See [Section 7.6 on page 124](#) for an example.
- See [Section 7.5 on page 120](#) for an example of configuring user accounts and user groups as part of user-aware access control.
- See [Section 7.6 on page 124](#) for an example of how to use a RADIUS server to authenticate user accounts based on groups.

33.2 User Summary Screen

The **User** screen provides a summary of all user accounts. To access this screen, login to the Web Configurator, and click **Configuration > Object > User/Group**.

Figure 319 Configuration > Object > User/Group

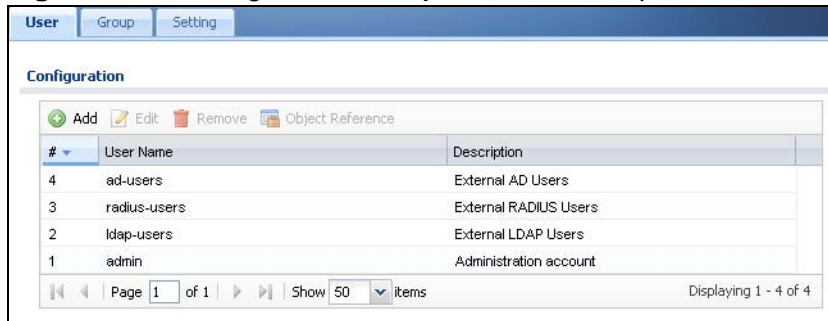

The following table describes the labels in this screen.

Table 152 Configuration > Object > User/Group

LABEL	DESCRIPTION
Add	Click this to create a new entry.
Edit	Double-click an entry or select it and click Edit to open a screen where you can modify the entry's settings.
Remove	To remove an entry, select it and click Remove . The ZyWALL confirms you want to remove it before doing so.
Object References	Select an entry and click Object References to open a screen that shows which settings use the entry. See Section 11.3.2 on page 232 for an example.
#	This field is a sequential value, and it is not associated with a specific user.
User Name	This field displays the user name of each user.
Description	This field displays the description for each user.

33.2.1 User Add/Edit Screen

The **User Add/Edit** screen allows you to create a new user account or edit an existing one.

33.2.1.1 Rules for User Names

Enter a user name from 1 to 31 characters.

The user name can only contain the following characters:

- Alphanumeric A-z 0-9 (there is no unicode support)
- _ [underscores]

- - [dashes]

The first character must be alphabetical (A-Z a-z), an underscore (_), or a dash (-). Other limitations on user names are:

- User names are case-sensitive. If you enter a user 'bob' but use 'BOB' when connecting via CIFS or FTP, it will use the account settings used for 'BOB' not 'bob'.
- User names have to be different than user group names.
- Here are the reserved user names:
 - adm
 - admin
 - any
 - bin
 - daemon
 - debug
 - devicehaecived
 - ftp
 - games
 - halt
 - ldap-users
 - lp
 - mail
 - news
 - nobody
 - operator
 - radius-users
 - root
 - shutdown
 - sshd
 - sync
 - uucp
 - zyxel

To access this screen, go to the **User** screen (see [Section 33.2 on page 542](#)), and click either the **Add** icon or an **Edit** icon.

Figure 320 Configuration > User/Group > User > Add

The following table describes the labels in this screen.

Table 153 Configuration > User/Group > User > Add

LABEL	DESCRIPTION
User Name	Type the user name for this user account. You may use 1-31 alphanumeric characters, underscores(_), or dashes (-), but the first character cannot be a number. This value is case-sensitive. User names have to be different than user group names, and some words are reserved. See Section 33.2.1.1 on page 542 .
User Type	<p>Select what type of user this is. Choices are:</p> <ul style="list-style-type: none"> • admin - this user can look at and change the configuration of the ZyWALL • limited-admin - this user can look at the configuration of the ZyWALL but not to change it • user - this user has access to the ZyWALL's services but cannot look at the configuration • guest - this user has access to the ZyWALL's services but cannot look at the configuration • ext-user - this user account is maintained in a remote server, such as RADIUS or LDAP. See Ext-User Accounts on page 540 for more information about this type. • ext-group-user - this user account is maintained in a remote server, such as RADIUS or LDAP. See Ext-Group-User Accounts on page 541 for more information about this type.
Password	<p>This field is not available if you select the ext-user or ext-group-user type.</p> <p>Enter the password of this user account. It can consist of 4 - 31 alphanumeric characters.</p>
Retype	This field is not available if you select the ext-user or ext-group-user type.
Group Identifier	<p>This field is available for a ext-group-user type user account.</p> <p>Specify the value of the AD or LDAP server's Group Membership Attribute that identifies the group to which this user belongs.</p>
Associated AAA Server Object	This field is available for a ext-group-user type user account. Select the AAA server to use to authenticate this account's users.
Description	Enter the description of each user, if any. You can use up to 60 printable ASCII characters. Default descriptions are provided.
Authentication Timeout Settings	<p>This field is not available if you select the ext-group-user type.</p> <p>If you want to set authentication timeout to a value other than the default settings, select Use Manual Settings then fill your preferred values in the fields that follow.</p>
Lease Time	<p>This field is not available if you select the ext-group-user type.</p> <p>Enter the number of minutes this user has to renew the current session before the user is logged out. You can specify 1 to 1440 minutes. You can enter 0 to make the number of minutes unlimited. Admin users renew the session every time the main screen refreshes in the Web Configurator. Access users can renew the session by clicking the Renew button on their screen. If you allow access users to renew time automatically (see Section 33.4 on page 547), the users can select this check box on their screen as well. In this case, the session is automatically renewed before the lease time expires.</p>

Table 153 Configuration > User/Group > User > Add (continued)

LABEL	DESCRIPTION
Reauthentication Time	This field is not available if you select the ext-group-user type. Type the number of minutes this user can be logged into the ZyWALL in one session before the user has to log in again. You can specify 1 to 1440 minutes. You can enter 0 to make the number of minutes unlimited. Unlike Lease Time , the user has no opportunity to renew the session without logging out.
Configuration Validation	Use a user account from the group specified above to test if the configuration is correct. Enter the account's user name in the User Name field and click Test .
OK	Click OK to save your changes back to the ZyWALL.
Cancel	Click Cancel to exit this screen without saving your changes.

33.3 User Group Summary Screen

User groups consist of access users and other user groups. You cannot put admin users in user groups. The **Group** screen provides a summary of all user groups. In addition, this screen allows you to add, edit, and remove user groups. To access this screen, login to the Web Configurator, and click **Configuration > Object > User/Group > Group**.

Figure 321 Configuration > Object > User/Group > Group

The following table describes the labels in this screen. See [Section 33.3.1 on page 546](#) for more information as well.

Table 154 Configuration > Object > User/Group > Group

LABEL	DESCRIPTION
Add	Click this to create a new entry.
Edit	Double-click an entry or select it and click Edit to open a screen where you can modify the entry's settings.
Remove	To remove an entry, select it and click Remove . The ZyWALL confirms you want to remove it before doing so. Removing a group does not remove the user accounts in the group.
Object References	Select an entry and click Object References to open a screen that shows which settings use the entry. See Section 11.3.2 on page 232 for an example.

Table 154 Configuration > Object > User/Group > Group (continued)

LABEL	DESCRIPTION
#	This field is a sequential value, and it is not associated with a specific user group.
Group Name	This field displays the name of each user group.
Description	This field displays the description for each user group.
Member	This field lists the members in the user group. Each member is separated by a comma.

33.3.1 Group Add/Edit Screen

The **Group Add/Edit** screen allows you to create a new user group or edit an existing one. To access this screen, go to the **Group** screen (see [Section 33.3 on page 545](#)), and click either the **Add** icon or an **Edit** icon.

Figure 322 Configuration > User/Group > Group > Add

The following table describes the labels in this screen.

Table 155 Configuration > User/Group > Group > Add

LABEL	DESCRIPTION
Name	Type the name for this user group. You may use 1-31 alphanumeric characters, underscores(_), or dashes (-), but the first character cannot be a number. This value is case-sensitive. User group names have to be different than user names.
Description	Enter the description of the user group, if any. You can use up to 60 characters, punctuation marks, and spaces.

Table 155 Configuration > User/Group > Group > Add (continued)

LABEL	DESCRIPTION
Member List	The Member list displays the names of the users and user groups that have been added to the user group. The order of members is not important. Select users and groups from the Available list that you want to be members of this group and move them to the Member list. You can double-click a single entry to move it or use the [Shift] or [Ctrl] key to select multiple entries and use the arrow button to move them. Move any members you do not want included to the Available list.
OK	Click OK to save your changes back to the ZyWALL.
Cancel	Click Cancel to exit this screen without saving your changes.

33.4 Setting Screen

The **Setting** screen controls default settings, login settings, lockout settings, and other user settings for the ZyWALL. You can also use this screen to specify when users must log in to the ZyWALL before it routes traffic for them.

To access this screen, login to the Web Configurator, and click **Configuration > Object > User/Group > Setting**.

Figure 323 Configuration > Object > User/Group > Setting

User Authentication Timeout Settings

Default Authentication Timeout Settings

#	User Type	Lease Time	Reauthentication Time
1	admin	1440	1440
2	limited-admin	1440	1440
3	user	1440	1440
4	guest	1440	1440
5	ext-user	1440	1440
6	ext-group-user	1440	1440

Page 1 of 1 | Show 50 items | Displaying 1 - 6 of 6

Miscellaneous Settings

Allow renewing lease time automatically

Enable user idle detection

User idle timeout: (1-60 minutes)

User Logon Settings

Limit the number of simultaneous logons for administration account

Maximum number per administration account: (1-256)

Limit the number of simultaneous logons for access account

Maximum number per access account: (1-256)

User Lockout Settings

Enable logon retry limit

Maximum retry count: (1-99)

Lockout period: (1-65535 minutes)

Apply Reset

The following table describes the labels in this screen.

Table 156 Configuration > Object > User/Group > Setting

LABEL	DESCRIPTION
User Authentication Timeout Settings	
Default Authentication Timeout Settings	These authentication timeout settings are used by default when you create a new user account. They also control the settings for any existing user accounts that are set to use the default settings. You can still manually configure any user account's authentication timeout settings.
Edit	Double-click an entry or select it and click Edit to open a screen where you can modify the entry's settings.
#	This field is a sequential value, and it is not associated with a specific entry.

Table 156 Configuration > Object > User/Group > Setting (continued)

LABEL	DESCRIPTION
User Type	<p>These are the kinds of user account the ZyWALL supports.</p> <ul style="list-style-type: none"> • admin - this user can look at and change the configuration of the ZyWALL • limited-admin - this user can look at the configuration of the ZyWALL but not to change it • user - this user has access to the ZyWALL's services but cannot look at the configuration • guest - this user has access to the ZyWALL's services but cannot look at the configuration • ext-user - this user account is maintained in a remote server, such as RADIUS or LDAP. See Ext-User Accounts on page 540 for more information about this type. • ext-group-user - this user account is maintained in a remote server, such as RADIUS or LDAP. See Ext-Group-User Accounts on page 541 for more information about this type.
Lease Time	<p>This is the default lease time in minutes for each type of user account. It defines the number of minutes the user has to renew the current session before the user is logged out.</p> <p>Admin users renew the session every time the main screen refreshes in the Web Configurator. Access users can renew the session by clicking the Renew button on their screen. If you allow access users to renew time automatically (see Section 33.4 on page 547), the users can select this checkbox on their screen as well. In this case, the session is automatically renewed before the lease time expires.</p>
Reauthentication Time	<p>This is the default reauthentication time in minutes for each type of user account. It defines the number of minutes the user can be logged into the ZyWALL in one session before having to log in again. Unlike Lease Time, the user has no opportunity to renew the session without logging out.</p>
Miscellaneous Settings	
Allow renewing lease time automatically	<p>Select this check box if access users can renew lease time automatically, as well as manually, simply by selecting the Updating lease time automatically check box on their screen.</p>
Enable user idle detection	<p>This is applicable for access users.</p> <p>Select this check box if you want the ZyWALL to monitor how long each access user is logged in and idle (in other words, there is no traffic for this access user). The ZyWALL automatically logs out the access user once the User idle timeout has been reached.</p>
User idle timeout	<p>This is applicable for access users.</p> <p>This field is effective when Enable user idle detection is checked. Type the number of minutes each access user can be logged in and idle before the ZyWALL automatically logs out the access user.</p>
User Logon Settings	

Table 156 Configuration > Object > User/Group > Setting (continued)

LABEL	DESCRIPTION
Limit the number of simultaneous logons for administration account	Select this check box if you want to set a limit on the number of simultaneous logins by admin users. If you do not select this, admin users can login as many times as they want at the same time using the same or different IP addresses.
Maximum number per administration account	This field is effective when Limit ... for administration account is checked. Type the maximum number of simultaneous logins by each admin user.
Limit the number of simultaneous logons for access account	Select this check box if you want to set a limit on the number of simultaneous logins by non-admin users. If you do not select this, access users can login as many times as they want as long as they use different IP addresses.
Maximum number per access account	This field is effective when Limit ... for access account is checked. Type the maximum number of simultaneous logins by each access user.
User Lockout Settings	
Enable logon retry limit	Select this check box to set a limit on the number of times each user can login unsuccessfully (for example, wrong password) before the IP address is locked out for a specified amount of time.
Maximum retry count	This field is effective when Enable logon retry limit is checked. Type the maximum number of times each user can login unsuccessfully before the IP address is locked out for the specified lockout period . The number must be between 1 and 99.
Lockout period	This field is effective when Enable logon retry limit is checked. Type the number of minutes the user must wait to try to login again, if logon retry limit is enabled and the maximum retry count is reached. This number must be between 1 and 65,535 (about 45.5 days).
Apply	Click Apply to save the changes.
Reset	Click Reset to return the screen to its last-saved settings.

33.4.1 Default User Authentication Timeout Settings Edit Screens

The **Default Authentication Timeout Settings Edit** screen allows you to set the default authentication timeout settings for the selected type of user account. These default authentication timeout settings also control the settings for any existing user accounts that are set to use the default settings. You can still manually configure any user account's authentication timeout settings.

To access this screen, go to the **Configuration > Object > User/Group > Setting** screen (see [Section 33.4 on page 547](#)), and click one of the **Default Authentication Timeout Settings** section's **Edit** icons.

Figure 324 Configuration > Object > User/Group > Setting > Edit

The following table describes the labels in this screen.

Table 157 Configuration > Object > User/Group > Setting > Edit

LABEL	DESCRIPTION
User Type	<p>This read-only field identifies the type of user account for which you are configuring the default settings.</p> <ul style="list-style-type: none"> • admin - this user can look at and change the configuration of the ZyWALL • limited-admin - this user can look at the configuration of the ZyWALL but not to change it • user - this user has access to the ZyWALL's services but cannot look at the configuration • ext-user - this user account is maintained in a remote server, such as RADIUS or LDAP. See Ext-User Accounts on page 540 for more information about this type. • ext-group-user - this user account is maintained in a remote server, such as RADIUS or LDAP. See Ext-Group-User Accounts on page 541 for more information about this type.
Lease Time	<p>Enter the number of minutes this type of user account has to renew the current session before the user is logged out. You can specify 1 to 1440 minutes. You can enter 0 to make the number of minutes unlimited.</p> <p>Admin users renew the session every time the main screen refreshes in the Web Configurator. Access users can renew the session by clicking the Renew button on their screen. If you allow access users to renew time automatically (see Section 33.4 on page 547), the users can select this check box on their screen as well. In this case, the session is automatically renewed before the lease time expires.</p>
Reauthentication Time	<p>Type the number of minutes this type of user account can be logged into the ZyWALL in one session before the user has to log in again. You can specify 1 to 1440 minutes. You can enter 0 to make the number of minutes unlimited. Unlike Lease Time, the user has no opportunity to renew the session without logging out.</p>
OK	<p>Click OK to save your changes back to the ZyWALL.</p>
Cancel	<p>Click Cancel to exit this screen without saving your changes.</p>

33.4.2 User Aware Login Example

Access users cannot use the Web Configurator to browse the configuration of the ZyWALL. Instead, after access users log into the ZyWALL, the following screen appears.

Figure 325 Web Configurator for Non-Admin Users



The following table describes the labels in this screen.

Table 158 Web Configurator for Non-Admin Users

LABEL	DESCRIPTION
User-defined lease time (max ... minutes)	Access users can specify a lease time shorter than or equal to the one that you specified. The default value is the lease time that you specified.
Renew	Access users can click this button to reset the lease time, the amount of time remaining before the ZyWALL automatically logs them out. The ZyWALL sets this amount of time according to the <ul style="list-style-type: none"> • User-defined lease time field in this screen • Lease time field in the User Add/Edit screen (see Section 33.2.1 on page 542) • Lease time field in the Setting screen (see Section 33.4 on page 547)
Updating lease time automatically	This box appears if you checked the Allow renewing lease time automatically box in the Setting screen. (See Section 33.4 on page 547 .) Access users can select this check box to reset the lease time automatically 30 seconds before it expires. Otherwise, access users have to click the Renew button to reset the lease time.
Remaining time before lease timeout	This field displays the amount of lease time that remains, though the user might be able to reset it.
Remaining time before auth. timeout	This field displays the amount of time that remains before the ZyWALL automatically logs the access user out, regardless of the lease time.

33.5 User /Group Technical Reference

This section provides some information on users who use an external authentication server in order to log in.

Setting up User Attributes in an External Server

To set up user attributes, such as reauthentication time, in LDAP or RADIUS servers, use the following keywords in the user configuration file.

Table 159 LDAP/RADIUS: Keywords for User Attributes

KEYWORD	CORRESPONDING ATTRIBUTE IN WEB CONFIGURATOR
type	User Type. Possible Values: admin, limited-admin, user, guest.
leaseTime	Lease Time. Possible Values: 1-1440 (minutes).
reauthTime	Reauthentication Time. Possible Values: 1-1440 (minutes).

The following examples show you how you might set up user attributes in LDAP and RADIUS servers.

Figure 326 LDAP Example: Keywords for User Attributes

```
type: admin
leaseTime: 99
reauthTime: 199
```

Figure 327 RADIUS Example: Keywords for User Attributes

```
type=user;leaseTime=222;reauthTime=222
```

Creating a Large Number of Ext-User Accounts

If you plan to create a large number of **Ext-User** accounts, you might use CLI commands, instead of the Web Configurator, to create the accounts. Extract the user names from the LDAP or RADIUS server, and create a shell script that creates the user accounts. See [Chapter 45 on page 693](#) for more information about shell scripts.

Addresses

34.1 Overview

Address objects can represent a single IP address or a range of IP addresses. Address groups are composed of address objects and other address groups.

34.1.1 What You Can Do in this Chapter

- The **Address** screen ([Section 34.2 on page 555](#)) provides a summary of all addresses in the ZyWALL. Use the **Address Add/Edit** screen to create a new address or edit an existing one.
- Use the **Address Group** summary screen ([Section 34.3 on page 558](#)) and the **Address Group Add/Edit** screen, to maintain address groups in the ZyWALL.

34.1.2 What You Need To Know

Address objects and address groups are used in dynamic routes, firewall rules, content filtering, and VPN connection policies. For example, addresses are used to specify where content restrictions apply in content filtering. Please see the respective sections for more information about how address objects and address groups are used in each one.

Address groups are composed of address objects and address groups. The sequence of members in the address group is not important.

- See [Section 6.6 on page 103](#) for related information on these screens.
- See [Section 7.12 on page 145](#) for how to create a public IP address range object for using multiple static public WAN IP addresses for LAN to WAN traffic.

34.2 Address Summary Screen

The address screens are used to create, maintain, and remove addresses. There are the types of address objects.

- **HOST** - a host address is defined by an **IP Address**.

- **RANGE** - a range address is defined by a **Starting IP Address** and an **Ending IP Address**.
- **SUBNET** - a network address is defined by a **Network IP address** and **Netmask** subnet mask.

The **Address** screen provides a summary of all addresses in the ZyWALL. To access this screen, click **Configuration > Object > Address > Address**. Click a column's heading cell to sort the table entries by that column's criteria. Click the heading cell again to reverse the sort order.

Figure 328 Configuration > Object > Address > Address (USG 20)

#	Name	Type	Address
1	DMZ_SUBNET	INTERFACE SUBNET	dmz-192.168.3.0/24
2	LAN1_SUBNET	INTERFACE SUBNET	lan1-192.168.1.0/24
3	LAN2_SUBNET	INTERFACE SUBNET	lan2-192.168.2.0/24

The following table describes the labels in this screen. See [Section 34.2.1 on page 557](#) for more information as well.

Table 160 Configuration > Object > Address > Address

LABEL	DESCRIPTION
Add	Click this to create a new entry.
Edit	Double-click an entry or select it and click Edit to be able to modify the entry's settings.
Remove	To remove an entry, select it and click Remove . The ZyWALL confirms you want to remove it before doing so.
Object References	Select an entry and click Object References to open a screen that shows which settings use the entry. See Section 11.3.2 on page 232 for an example.
#	This field is a sequential value, and it is not associated with a specific address.
Name	This field displays the configured name of each address object.
Type	This field displays the type of each address object. " INTERFACE " means the object uses the settings of one of the ZyWALL's interfaces.
Address	This field displays the IP addresses represented by each address object. If the object's settings are based on one of the ZyWALL's interfaces, the name of the interface displays first followed by the object's current address settings.

34.2.1 Address Add/Edit Screen

The **Configuration > Address Add/Edit** screen allows you to create a new address or edit an existing one. To access this screen, go to the **Address** screen (see [Section 34.2 on page 555](#)), and click either the **Add** icon or an **Edit** icon.

Figure 329 Configuration > Object > Address > Address > Edit

The following table describes the labels in this screen.

Table 161 Configuration > Object > Address > Address > Edit

LABEL	DESCRIPTION
Name	Type the name used to refer to the address. You may use 1-31 alphanumeric characters, underscores(_), or dashes (-), but the first character cannot be a number. This value is case-sensitive.
Address Type	Select the type of address you want to create. Choices are: HOST , RANGE , SUBNET , INTERFACE IP , INTERFACE SUBNET , and INTERFACE GATEWAY . Note: The ZyWALL automatically updates address objects that are based on an interface's IP address, subnet, or gateway if the interface's IP address settings change. For example, if you change ge1's IP address, the ZyWALL automatically updates the corresponding interface-based, LAN subnet address object.
IP Address	This field is only available if the Address Type is HOST . This field cannot be blank. Enter the IP address that this address object represents.
Starting IP Address	This field is only available if the Address Type is RANGE . This field cannot be blank. Enter the beginning of the range of IP addresses that this address object represents.
Ending IP Address	This field is only available if the Address Type is RANGE . This field cannot be blank. Enter the end of the range of IP address that this address object represents.
Network	This field is only available if the Address Type is SUBNET , in which case this field cannot be blank. Enter the IP address of the network that this address object represents.
Netmask	This field is only available if the Address Type is SUBNET , in which case this field cannot be blank. Enter the subnet mask of the network that this address object represents. Use dotted decimal format.

Table 161 Configuration > Object > Address > Address > Edit (continued)

LABEL	DESCRIPTION
Interface	If you selected INTERFACE IP , INTERFACE SUBNET , or INTERFACE GATEWAY as the Address Type , use this field to select the interface of the network that this address object represents.
OK	Click OK to save your changes back to the ZyWALL.
Cancel	Click Cancel to exit this screen without saving your changes.

34.3 Address Group Summary Screen

The **Address Group** screen provides a summary of all address groups. To access this screen, click **Configuration > Object > Address > Address Group**. Click a column's heading cell to sort the table entries by that column's criteria. Click the heading cell again to reverse the sort order.

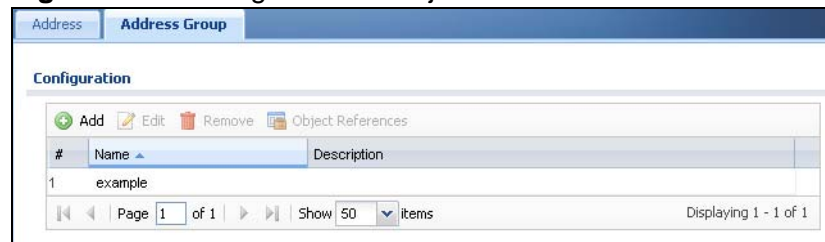
Figure 330 Configuration > Object > Address > Address Group

The following table describes the labels in this screen. See [Section 34.3.1 on page 559](#) for more information as well.

Table 162 Configuration > Object > Address > Address Group

LABEL	DESCRIPTION
Add	Click this to create a new entry.
Edit	Double-click an entry or select it and click Edit to be able to modify the entry's settings.
Remove	To remove an entry, select it and click Remove . The ZyWALL confirms you want to remove it before doing so.
Object References	Select an entry and click Object References to open a screen that shows which settings use the entry. See Section 11.3.2 on page 232 for an example.
#	This field is a sequential value, and it is not associated with a specific address group.
Name	This field displays the name of each address group.
Description	This field displays the description of each address group, if any.

34.3.1 Address Group Add/Edit Screen

The **Address Group Add/Edit** screen allows you to create a new address group or edit an existing one. To access this screen, go to the **Address Group** screen (see [Section 34.3 on page 558](#)), and click either the **Add** icon or an **Edit** icon.

Figure 331 Configuration > Object > Address > Address Group > Add (USG 20)

The following table describes the labels in this screen.

Table 163 Configuration > Object > Address > Address Group > Add

LABEL	DESCRIPTION
Name	Enter a name for the address group. You may use 1-31 alphanumeric characters, underscores(_), or dashes (-), but the first character cannot be a number. This value is case-sensitive.
Description	This field displays the description of each address group, if any. You can use up to 60 characters, punctuation marks, and spaces.
Member List	<p>The Member list displays the names of the address and address group objects that have been added to the address group. The order of members is not important.</p> <p>Select items from the Available list that you want to be members and move them to the Member list. You can double-click a single entry to move it or use the [Shift] or [Ctrl] key to select multiple entries and use the arrow button to move them.</p> <p>Move any members you do not want included to the Available list.</p>
OK	Click OK to save your changes back to the ZyWALL.
Cancel	Click Cancel to exit this screen without saving your changes.

Services

35.1 Overview

Use service objects to define TCP applications, UDP applications, and ICMP messages. You can also create service groups to refer to multiple service objects in other features.

35.1.1 What You Can Do in this Chapter

- Use the **Service** screens ([Section 35.2 on page 562](#)) to view and configure the ZyWALL's list of services and their definitions.
- Use the **Service Group** screens ([Section 35.2 on page 562](#)) to view and configure the ZyWALL's list of service groups.

35.1.2 What You Need to Know

IP Protocols

IP protocols are based on the eight-bit protocol field in the IP header. This field represents the next-level protocol that is sent in this packet. This section discusses three of the most common IP protocols.

Computers use Transmission Control Protocol (TCP, IP protocol 6) and User Datagram Protocol (UDP, IP protocol 17) to exchange data with each other. TCP guarantees reliable delivery but is slower and more complex. Some uses are FTP, HTTP, SMTP, and TELNET. UDP is simpler and faster but is less reliable. Some uses are DHCP, DNS, RIP, and SNMP.

TCP creates connections between computers to exchange data. Once the connection is established, the computers exchange data. If data arrives out of sequence or is missing, TCP puts it in sequence or waits for the data to be re-transmitted. Then, the connection is terminated.

In contrast, computers use UDP to send short messages to each other. There is no guarantee that the messages arrive in sequence or that the messages arrive at all.

Both TCP and UDP use ports to identify the source and destination. Each port is a 16-bit number. Some port numbers have been standardized and are used by low-level system processes; many others have no particular meaning.

Unlike TCP and UDP, Internet Control Message Protocol (ICMP, IP protocol 1) is mainly used to send error messages or to investigate problems. For example, ICMP is used to send the response if a computer cannot be reached. Another use is ping. ICMP does not guarantee delivery, but networks often treat ICMP messages differently, sometimes looking at the message itself to decide where to send it.

Service Objects and Service Groups

Use service objects to define IP protocols.

- TCP applications
- UDP applications
- ICMP messages
- user-defined services (for other types of IP protocols)

These objects are used in policy routes, firewall rules.

Use service groups when you want to create the same rule for several services, instead of creating separate rules for each service. Service groups may consist of services and other service groups. The sequence of members in the service group is not important.

Finding Out More

- See [Section 6.6 on page 103](#) for related information on these screens.
- See [Appendix B on page 799](#) for a list of commonly-used services.

35.2 The Service Summary Screen

The **Service** summary screen provides a summary of all services and their definitions. In addition, this screen allows you to add, edit, and remove services.

To access this screen, log in to the Web Configurator, and click **Configuration > Object > Service > Service**. Click a column's heading cell to sort the table

entries by that column's criteria. Click the heading cell again to reverse the sort order.

Figure 332 Configuration > Object > Service > Service

#	Name	Content
1	AH	Protocol=51
2	AIM	TCP=5190
3	AUTH	TCP=113
4	Any_TCP	TCP/1-65535
5	Any_UDP	UDP/1-65535
6	BGP	TCP=179
7	BOOTP_CLIENT	UDP=68
8	BOOTP_SERVER	UDP=67
9	CU_SEEME_TCP1	TCP=7648
10	CU_SEEME_TCP2	TCP=24032
11	CU_SEEME_UDP1	UDP=7648
12	CU_SEEME_UDP2	UDP=24032
13	DNS_TCP	TCP=53
14	DNS_UDP	UDP=53
15	ESP	Protocol=50
16	FINGER	TCP=79
17	FTP	TCP/20-21
18	H323	TCP=1720
19	HTTP	TCP=80
20	HTTPS	TCP=443

The following table describes the labels in this screen.

Table 164 Configuration > Object > Service > Service

LABEL	DESCRIPTION
Add	Click this to create a new entry.
Edit	Double-click an entry or select it and click Edit to be able to modify the entry's settings.
Remove	To remove an entry, select it and click Remove . The ZyWALL confirms you want to remove it before doing so.
Object References	Select an entry and click Object References to open a screen that shows which settings use the entry. See Section 11.3.2 on page 232 for an example.
#	This field is a sequential value, and it is not associated with a specific service.
Name	This field displays the name of each service.
Content	This field displays a description of each service.

35.2.1 The Service Add/Edit Screen

The **Service Add/Edit** screen allows you to create a new service or edit an existing one. To access this screen, go to the **Service** screen (see [Section 35.2 on page 562](#)), and click either the **Add** icon or an **Edit** icon.

Figure 333 Configuration > Object > Service > Service > Edit

The following table describes the labels in this screen.

Table 165 Configuration > Object > Service > Service > Edit

LABEL	DESCRIPTION
Name	Type the name used to refer to the service. You may use 1-31 alphanumeric characters, underscores(_), or dashes (-), but the first character cannot be a number. This value is case-sensitive.
IP Protocol	Select the protocol the service uses. Choices are: TCP , UDP , ICMP , and User Defined .
Starting Port Ending Port	This field appears if the IP Protocol is TCP or UDP . Specify the port number(s) used by this service. If you fill in one of these fields, the service uses that port. If you fill in both fields, the service uses the range of ports.
ICMP Type	This field appears if the IP Protocol is ICMP Type . Select the ICMP message used by this service. This field displays the message text, not the message number.
IP Protocol Number	This field appears if the IP Protocol is User Defined . Enter the number of the next-level protocol (IP protocol). Allowed values are 0 - 255.
OK	Click OK to save your changes back to the ZyWALL.
Cancel	Click Cancel to exit this screen without saving your changes.

35.3 The Service Group Summary Screen

The **Service Group** summary screen provides a summary of all service groups. In addition, this screen allows you to add, edit, and remove service groups.

To access this screen, log in to the Web Configurator, and click **Configuration > Object > Service > Service Group**.

Figure 334 Configuration > Object > Service > Service Group

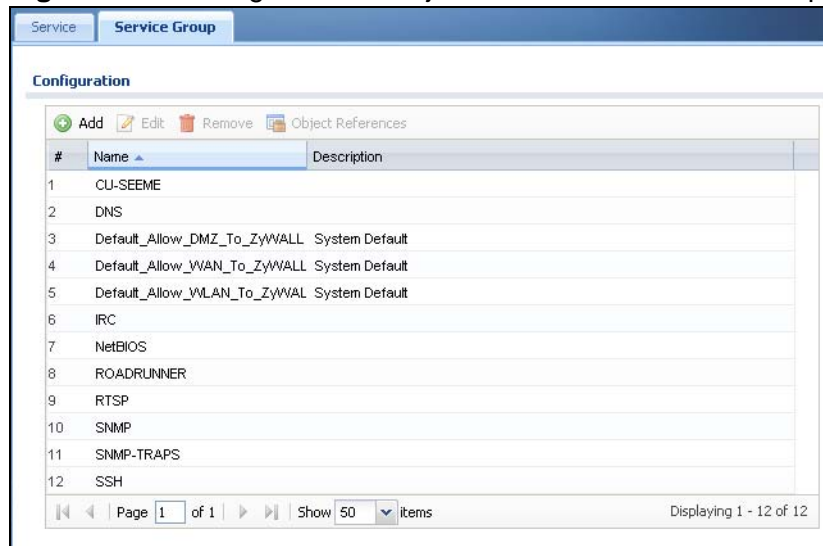

The following table describes the labels in this screen. See [Section 35.3.1 on page 566](#) for more information as well.

Table 166 Configuration > Object > Service > Service Group

LABEL	DESCRIPTION
Add	Click this to create a new entry.
Edit	Double-click an entry or select it and click Edit to be able to modify the entry's settings.
Remove	To remove an entry, select it and click Remove . The ZyWALL confirms you want to remove it before doing so.
Object References	Select an entry and click Object References to open a screen that shows which settings use the entry. See Section 11.3.2 on page 232 for an example.
#	This field is a sequential value, and it is not associated with a specific service group.
Name	This field displays the name of each service group. By default, the ZyWALL uses services starting with "Default-Allow_" in the firewall rules to allow certain services to connect to the ZyWALL.
Description	This field displays the description of each service group, if any.

35.3.1 The Service Group Add/Edit Screen

The **Service Group Add/Edit** screen allows you to create a new service group or edit an existing one. To access this screen, go to the **Service Group** screen (see [Section 35.3 on page 564](#)), and click either the **Add** icon or an **Edit** icon.

Figure 335 Configuration > Object > Service > Service Group > Edit

The following table describes the labels in this screen.

Table 167 Configuration > Object > Service > Service Group > Edit

LABEL	DESCRIPTION
Name	Enter the name of the service group. You may use 1-31 alphanumeric characters, underscores(_), or dashes (-), but the first character cannot be a number. This value is case-sensitive.
Description	Enter a description of the service group, if any. You can use up to 60 printable ASCII characters.
Member List	<p>The Member list displays the names of the service and service group objects that have been added to the service group. The order of members is not important.</p> <p>Select items from the Available list that you want to be members and move them to the Member list. You can double-click a single entry to move it or use the [Shift] or [Ctrl] key to select multiple entries and use the arrow button to move them.</p> <p>Move any members you do not want included to the Available list.</p>
OK	Click OK to save your changes back to the ZyWALL.
Cancel	Click Cancel to exit this screen without saving your changes.

Schedules

36.1 Overview

Use schedules to set up one-time and recurring schedules for policy routes, firewall rules, and content filtering. The ZyWALL supports one-time and recurring schedules. One-time schedules are effective only once, while recurring schedules usually repeat. Both types of schedules are based on the current date and time in the ZyWALL.

Note: Schedules are based on the ZyWALL's current date and time.

36.1.1 What You Can Do in this Chapter

- Use the **Schedule** summary screen ([Section 36.2 on page 568](#)) to see a list of all schedules in the ZyWALL.
- Use the **One-Time Schedule Add/Edit** screen ([Section 36.2.1 on page 569](#)) to create or edit a one-time schedule.
- Use the **Recurring Schedule Add/Edit** screen ([Section 36.2.2 on page 570](#)) to create or edit a recurring schedule.

36.1.2 What You Need to Know

One-time Schedules

One-time schedules begin on a specific start date and time and end on a specific stop date and time. One-time schedules are useful for long holidays and vacation periods.

Recurring Schedules

Recurring schedules begin at a specific start time and end at a specific stop time on selected days of the week (Sunday, Monday, Tuesday, Wednesday, Thursday, Friday, and Saturday). Recurring schedules always begin and end in the same day. Recurring schedules are useful for defining the workday and off-work hours.

Finding Out More

- See [Section 6.6 on page 103](#) for related information on these screens.
- See [Section 43.4 on page 631](#) for information about the ZyWALL's current date and time.

36.2 The Schedule Summary Screen

The **Schedule** summary screen provides a summary of all schedules in the ZyWALL. To access this screen, click **Configuration > Object > Schedule**.

Figure 336 Configuration > Object > Schedule

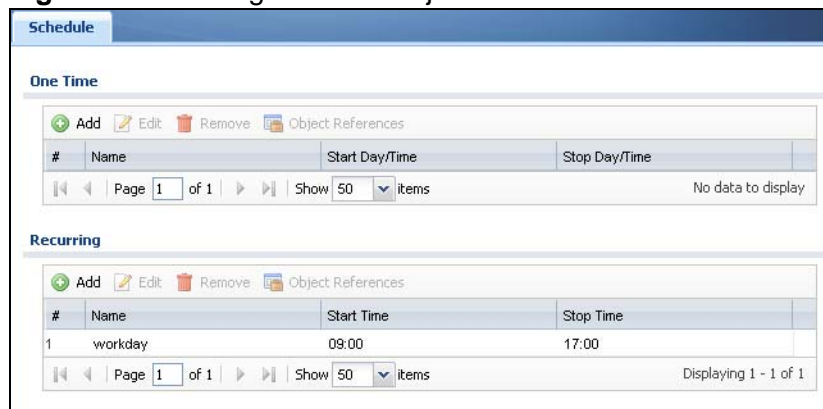

The following table describes the labels in this screen. See [Section 36.2.1 on page 569](#) and [Section 36.2.2 on page 570](#) for more information as well.

Table 168 Configuration > Object > Schedule

LABEL	DESCRIPTION
One Time	
Add	Click this to create a new entry.
Edit	Double-click an entry or select it and click Edit to be able to modify the entry's settings.
Remove	To remove an entry, select it and click Remove . The ZyWALL confirms you want to remove it before doing so.
Object References	Select an entry and click Object References to open a screen that shows which settings use the entry. See Section 11.3.2 on page 232 for an example.
#	This field is a sequential value, and it is not associated with a specific schedule.
Name	This field displays the name of the schedule, which is used to refer to the schedule.
Start Day / Time	This field displays the date and time at which the schedule begins.
Stop Day / Time	This field displays the date and time at which the schedule ends.

Table 168 Configuration > Object > Schedule (continued)

LABEL	DESCRIPTION
Recurring	
Add	Click this to create a new entry.
Edit	Double-click an entry or select it and click Edit to be able to modify the entry's settings.
Remove	To remove an entry, select it and click Remove . The ZyWALL confirms you want to remove it before doing so.
Object References	Select an entry and click Object References to open a screen that shows which settings use the entry. See Section 11.3.2 on page 232 for an example.
#	This field is a sequential value, and it is not associated with a specific schedule.
Name	This field displays the name of the schedule, which is used to refer to the schedule.
Start Time	This field displays the time at which the schedule begins.
Stop Time	This field displays the time at which the schedule ends.

36.2.1 The One-Time Schedule Add/Edit Screen

The **One-Time Schedule Add/Edit** screen allows you to define a one-time schedule or edit an existing one. To access this screen, go to the **Schedule** screen (see [Section 36.2 on page 568](#)), and click either the **Add** icon or an **Edit** icon in the **One Time** section.

Figure 337 Configuration > Object > Schedule > Edit (One Time)

The following table describes the labels in this screen.

Table 169 Configuration > Object > Schedule > Edit (One Time)

LABEL	DESCRIPTION
Configuration	
Name	Type the name used to refer to the one-time schedule. You may use 1-31 alphanumeric characters, underscores(_), or dashes (-), but the first character cannot be a number. This value is case-sensitive.

Table 169 Configuration > Object > Schedule > Edit (One Time) (continued)

LABEL	DESCRIPTION
Date Time	
StartDate	Specify the year, month, and day when the schedule begins. Year - 1900 - 2999 Month - 1 - 12 Day - 1 - 31 (it is not possible to specify illegal dates, such as February 31.) Hour - 0 - 23 Minute - 0 - 59
StartTime	Specify the hour and minute when the schedule begins. Hour - 0 - 23 Minute - 0 - 59
StopDate	Specify the year, month, and day when the schedule ends. Year - 1900 - 2999 Month - 1 - 12 Day - 1 - 31 (it is not possible to specify illegal dates, such as February 31.) Hour - 0 - 23 Minute - 0 - 59
StopTime	Specify the hour and minute when the schedule ends. Hour - 0 - 23 Minute - 0 - 59
OK	Click OK to save your changes back to the ZyWALL.
Cancel	Click Cancel to exit this screen without saving your changes.

36.2.2 The Recurring Schedule Add/Edit Screen

The **Recurring Schedule Add/Edit** screen allows you to define a recurring schedule or edit an existing one. To access this screen, go to the **Schedule** screen

(see [Section 36.2 on page 568](#)), and click either the **Add** icon or an **Edit** icon in the **Recurring** section.

Figure 338 Configuration > Object > Schedule > Edit (Recurring)

The screenshot shows a dialog box titled "Add Schedule Recurring Rule". It is divided into three main sections: "Configuration", "Day Time", and "Weekly".

- Configuration:** Contains a "Name:" label followed by a text input field. A red exclamation mark icon is visible to the right of the field.
- Day Time:** Contains "StartTime:" and "StopTime:" labels, each followed by a time selection control (hour and minute spinners) and a red exclamation mark icon.
- Weekly:** Contains a "Week Days:" label followed by seven checkboxes, each with a day name: Monday, Tuesday, Wednesday, Thursday, Friday, Saturday, and Sunday. All checkboxes are checked.

At the bottom right of the dialog are "OK" and "Cancel" buttons.

The **Year**, **Month**, and **Day** columns are not used in recurring schedules and are disabled in this screen. The following table describes the remaining labels in this screen.

Table 170 Configuration > Object > Schedule > Edit (Recurring)

LABEL	DESCRIPTION
Configuration	
Name	Type the name used to refer to the recurring schedule. You may use 1-31 alphanumeric characters, underscores(_), or dashes (-), but the first character cannot be a number. This value is case-sensitive.
Date Time	
StartTime	Specify the hour and minute when the schedule begins each day. Hour - 0 - 23 Minute - 0 - 59
StopTime	Specify the hour and minute when the schedule ends each day. Hour - 0 - 23 Minute - 0 - 59
Weekly	
Week Days	Select each day of the week the recurring schedule is effective.
OK	Click OK to save your changes back to the ZyWALL.
Cancel	Click Cancel to exit this screen without saving your changes.

AAA Server

37.1 Overview

You can use a AAA (Authentication, Authorization, Accounting) server to provide access control to your network. The AAA server can be a Active Directory, LDAP, or RADIUS server. Use the **AAA Server** screens to create and manage objects that contain settings for using AAA servers. You use AAA server objects in configuring ext-group-user user objects and authentication method objects (see [Chapter 38 on page 583](#)).

37.1.1 Directory Service (AD/LDAP)

LDAP/AD allows a client (the ZyWALL) to connect to a server to retrieve information from a directory. A network example is shown next.

Figure 339 Example: Directory Service Client and Server



The following describes the user authentication procedure via an LDAP/AD server.

- 1 A user logs in with a user name and password pair.
- 2 The ZyWALL tries to bind (or log in) to the LDAP/AD server.
- 3 When the binding process is successful, the ZyWALL checks the user information in the directory against the user name and password pair.
- 4 If it matches, the user is allowed access. Otherwise, access is blocked.

37.1.2 RADIUS Server

RADIUS (Remote Authentication Dial-In User Service) authentication is a popular protocol used to authenticate users by means of an external server instead of (or in addition to) an internal device user database that is limited to the memory capacity of the device. In essence, RADIUS authentication allows you to validate a large number of users from a central location.

Figure 340 RADIUS Server Network Example



37.1.3 ASAS

ASAS (Authenex Strong Authentication System) is a RADIUS server that works with the One-Time Password (OTP) feature. Purchase a ZyWALL OTP package in order to use this feature. The package contains server software and physical OTP tokens (PIN generators). Do the following to use OTP. See the documentation included on the ASAS' CD for details.

- 1 Install the ASAS server software on a computer.
- 2 Create user accounts on the ZyWALL and in the ASAS server.
- 3 Import each token's database file (located on the included CD) into the server.
- 4 Assign users to OTP tokens (on the ASAS server).
- 5 Configure the ASAS as a RADIUS server in the ZyWALL's **Configuration > Object > AAA Server** screens.
- 6 Give the OTP tokens to (local or remote) users.

37.1.4 What You Can Do in this Chapter

- Use the **Configuration > Object > AAA Server > Active Directory** (or **LDAP**) screens ([Section 37.2 on page 577](#)) to configure Active Directory or LDAP server objects.

- Use the **Configuration > Object > AAA Server > RADIUS** screen ([Section 37.3 on page 579](#)) to configure the default external RADIUS server to use for user authentication.

37.1.5 What You Need To Know

AAA Servers Supported by the ZyWALL

The following lists the types of authentication server the ZyWALL supports.

- Local user database

The ZyWALL uses the built-in local user database to authenticate administrative users logging into the ZyWALL's Web Configurator or network access users logging into the network through the ZyWALL. You can also use the local user database to authenticate VPN users.

- Directory Service (LDAP/AD)

LDAP (Lightweight Directory Access Protocol)/AD (Active Directory) is a directory service that is both a directory and a protocol for controlling access to a network. The directory consists of a database specialized for fast information retrieval and filtering activities. You create and store user profile and login information on the external server.

- RADIUS

RADIUS (Remote Authentication Dial-In User Service) authentication is a popular protocol used to authenticate users by means of an external or built-in RADIUS server. RADIUS authentication allows you to validate a large number of users from a central location.

Directory Structure

The directory entries are arranged in a hierarchical order much like a tree structure. Normally, the directory structure reflects the geographical or

organizational boundaries. The following figure shows a basic directory structure branching from countries to organizations to organizational units to individuals.

Figure 341 Basic Directory Structure

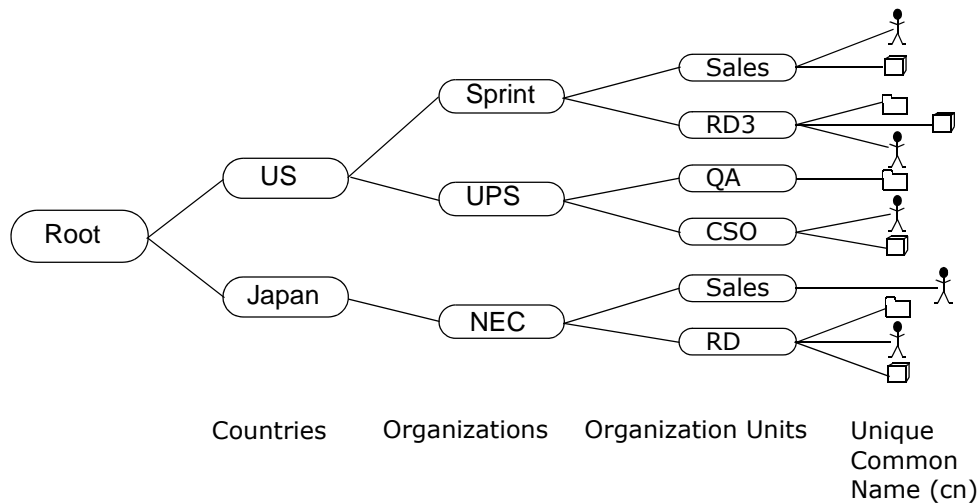

Distinguished Name (DN)

A DN uniquely identifies an entry in a directory. A DN consists of attribute-value pairs separated by commas. The leftmost attribute is the Relative Distinguished Name (RDN). This provides a unique name for entries that have the same "parent DN" ("cn=domain1.com, ou=Sales, o=MyCompany" in the following examples).

```
cn=domain1.com, ou = Sales, o=MyCompany, c=US
cn=domain1.com, ou = Sales, o=MyCompany, c=JP
```

Base DN

A base DN specifies a directory. A base DN usually contains information such as the name of an organization, a domain name and/or country. For example, o=MyCompany, c=UK where o means organization and c means country.

Bind DN

A bind DN is used to authenticate with an LDAP/AD server. For example a bind DN of cn=zywallAdmin allows the ZyWALL to log into the LDAP/AD server using the user name of zywallAdmin. The bind DN is used in conjunction with a bind password. When a bind DN is not specified, the ZyWALL will try to log in as an anonymous user. If the bind password is incorrect, the login will fail.

Finding Out More

- See [Section 7.5.3 on page 122](#) for an example of how to set up user authentication using a radius server.

- See [Section 7.6 on page 124](#) for an example of how to use a RADIUS server to authenticate user accounts based on groups.

37.2 Active Directory or LDAP Server Summary

Use the **Active Directory** or **LDAP** screen to manage the list of AD or LDAP servers the ZyWALL can use in authenticating users.

Click **Configuration > Object > AAA Server > Active Directory** (or **LDAP**) to display the **Active Directory** (or **LDAP**) screen.

Figure 342 Configuration > Object > AAA Server > Active Directory (or LDAP)

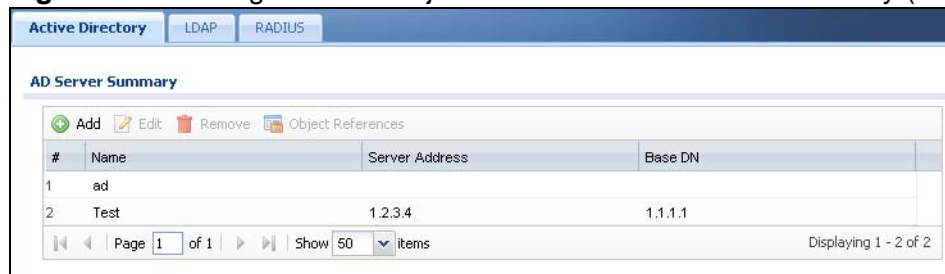

The following table describes the labels in this screen.

Table 171 Configuration > Object > AAA Server > Active Directory (or LDAP)

LABEL	DESCRIPTION
Add	Click this to create a new entry.
Edit	Double-click an entry or select it and click Edit to open a screen where you can modify the entry's settings.
Remove	To remove an entry, select it and click Remove . The ZyWALL confirms you want to remove it before doing so.
Object References	Select an entry and click Object References to open a screen that shows which settings use the entry. See Section 11.3.2 on page 232 for an example.
#	This field displays the index number.
Server Address	This is the address of the AD or LDAP server.
Base DN	This specifies a directory. For example, <code>o=ZYXEL, c=US</code> .

37.2.1 Adding an Active Directory or LDAP Server

Click **Object > AAA Server > Active Directory** (or **LDAP**) to display the **Active Directory** (or **LDAP**) screen. Click the **Add** icon or an **Edit** icon to display the

following screen. Use this screen to create a new AD or LDAP entry or edit an existing one.

Figure 343 Configuration > Object > AAA Server > Active Directory (or LDAP) > Add

The following table describes the labels in this screen.

Table 172 Configuration > Object > AAA Server > Active Directory (or LDAP) > Add

LABEL	DESCRIPTION
Name	Enter a descriptive name (up to 63 alphanumerical characters) for identification purposes.
Description	Enter the description of each server, if any. You can use up to 60 printable ASCII characters.
Server Address	Enter the address of the AD or LDAP server.
Backup Server Address	If the AD or LDAP server has a backup server, enter its address here.
Port	Specify the port number on the AD or LDAP server to which the ZyWALL sends authentication requests. Enter a number between 1 and 65535. This port number should be the same on all AD or LDAP server(s) in this group.

Table 172 Configuration > Object > AAA Server > Active Directory (or LDAP) > Add

LABEL	DESCRIPTION
Base DN	Specify the directory (up to 127 alphanumerical characters). For example, o=ZyXEL, c=US.
Use SSL	Select Use SSL to establish a secure connection to the AD or LDAP server(s).
Search time limit	Specify the timeout period (between 1 and 300 seconds) before the ZyWALL disconnects from the AD or LDAP server. In this case, user authentication fails. Search timeout occurs when either the user information is not in the AD or LDAP server(s) or the AD or LDAP server(s) is down.
Bind DN	Specify the bind DN for logging into the AD or LDAP server. Enter up to 127 alphanumerical characters. For example, cn=zywallAdmin specifies zywallAdmin as the user name.
Password	If required, enter the password (up to 15 alphanumerical characters) for the ZyWALL to bind (or log in) to the AD or LDAP server.
Base DN	Specify the directory (up to 127 alphanumerical characters). For example, o=ZyXEL, c=US.
Login Name Attribute	Enter the type of identifier the users are to use to log in. For example "name" or "e-mail address".
Alternative Login Name Attribute	If there is a second type of identifier that the users can use to log in, enter it here. For example "name" or "e-mail address".
Group Membership Attribute	An AD or LDAP server defines attributes for its accounts. Enter the name of the attribute that the ZyWALL is to check to determine to which group a user belongs. The value for this attribute is called a group identifier; it determines to which group a user belongs. You can add ext-group-user user objects to identify groups based on these group identifier values. For example you could have an attribute named "memberOf" with values like "sales", "RD", and "management". Then you could also create a ext-group-user user object for each group. One with "sales" as the group identifier, another for "RD" and a third for "management".
Configuration Validation	Use a user account from the server specified above to test if the configuration is correct. Enter the account's user name in the Username field and click Test .
OK	Click OK to save the changes.
Cancel	Click Cancel to discard the changes.

37.3 RADIUS Server Summary

Use the **RADIUS** screen to manage the list of RADIUS servers the ZyWALL can use in authenticating users.

Click **Configuration > Object > AAA Server > RADIUS** to display the **RADIUS** screen.

Figure 344 Configuration > Object > AAA Server > RADIUS



The following table describes the labels in this screen.

Table 173 Configuration > Object > AAA Server > RADIUS

LABEL	DESCRIPTION
Add	Click this to create a new entry.
Edit	Double-click an entry or select it and click Edit to open a screen where you can modify the entry's settings.
Remove	To remove an entry, select it and click Remove . The ZyWALL confirms you want to remove it before doing so.
Object References	Select an entry and click Object References to open a screen that shows which settings use the entry. See Section 11.3.2 on page 232 for an example.
#	This field displays the index number.
Name	This is the name of the RADIUS server entry.
Server Address	This is the address of the AD or LDAP server.
Base DN	This specifies a directory. For example, <code>o=ZYXEL, c=US</code> .
Host	Enter the IP address (in dotted decimal notation) or the domain name (up to 63 alphanumeric characters) of a RADIUS server.
Authentication Port	The default port of the RADIUS server for authentication is 1812 . You need not change this value unless your network administrator instructs you to do so with additional information.
Key	Enter a password (up to 15 alphanumeric characters) as the key to be shared between the external authentication server and the ZyWALL. The key is not sent over the network. This key must be the same on the external authentication server and the ZyWALL.
Timeout	Specify the timeout period (between 1 and 300 seconds) before the ZyWALL disconnects from the RADIUS server. In this case, user authentication fails. Search timeout occurs when either the user information is not in the RADIUS server or the RADIUS server is down.
Apply	Click Apply to save the changes.
Reset	Click Reset to return the screen to its last-saved settings.

37.3.1 Adding a RADIUS Server

Click **Configuration > Object > AAA Server > RADIUS** to display the **RADIUS** screen. Click the **Add** icon or an **Edit** icon to display the following screen. Use this screen to create a new AD or LDAP entry or edit an existing one.

Figure 345 Configuration > Object > AAA Server > RADIUS > Add

The screenshot shows the 'Add RADIUS' configuration window. It is divided into four main sections:

- General Settings:** Includes a 'Name' field with the value 'New' and a 'Description' field labeled as 'Optional'.
- Server Settings:** Includes 'Server Address' (IP or FQDN), 'Authentication Port' (1812), 'Backup Server Address' (Optional), 'Backup Authentication Port' (Optional), and 'Timeout' (5).
- Server Authentication:** Includes a 'Key' field.
- User Login Settings:** Includes a 'Group Membership Attribute' dropdown menu set to 'User Defined' and a value field set to '26'.

Buttons for 'OK' and 'Cancel' are located at the bottom right of the window.

The following table describes the labels in this screen.

Table 174 Configuration > Object > AAA Server > RADIUS > Add

LABEL	DESCRIPTION
Name	Enter a descriptive name (up to 63 alphanumerical characters) for identification purposes.
Description	Enter the description of each server, if any. You can use up to 60 printable ASCII characters.
Server Address	Enter the address of the RADIUS server.
Authentication Port	Specify the port number on the RADIUS server to which the ZyWALL sends authentication requests. Enter a number between 1 and 65535.
Backup Server Address	If the RADIUS server has a backup server, enter its address here.
Backup Authentication Port	Specify the port number on the RADIUS server to which the ZyWALL sends authentication requests. Enter a number between 1 and 65535.

Table 174 Configuration > Object > AAA Server > RADIUS > Add (continued)

LABEL	DESCRIPTION
Timeout	<p>Specify the timeout period (between 1 and 300 seconds) before the ZyWALL disconnects from the RADIUS server. In this case, user authentication fails.</p> <p>Search timeout occurs when either the user information is not in the RADIUS server or the RADIUS server is down.</p>
Key	<p>Enter a password (up to 15 alphanumeric characters) as the key to be shared between the external authentication server and the ZyWALL.</p> <p>The key is not sent over the network. This key must be the same on the external authentication server and the ZyWALL.</p>
Group Membership Attribute	<p>A RADIUS server defines attributes for its accounts. Select the name and number of the attribute that the ZyWALL is to check to determine to which group a user belongs. If it does not display, select user-defined and specify the attribute's number.</p> <p>This attribute's value is called a group identifier; it determines to which group a user belongs. You can add ext-group-user user objects to identify groups based on these group identifier values.</p> <p>For example you could have an attribute named "memberOf" with values like "sales", "RD", and "management". Then you could also create a ext-group-user user object for each group. One with "sales" as the group identifier, another for "RD" and a third for "management".</p>
OK	Click OK to save the changes.
Cancel	Click Cancel to discard the changes.

Authentication Method

38.1 Overview

Authentication method objects set how the ZyWALL authenticates wireless, HTTP/HTTPS clients, and peer IPSec routers (extended authentication) clients. Configure authentication method objects to have the ZyWALL use the local user database, and/or the authentication servers and authentication server groups specified by AAA server objects. By default, user accounts created and stored on the ZyWALL are authenticated locally.

38.1.1 What You Can Do in this Chapter

- Use the **Configuration > Object > Auth. Method** screens ([Section 38.2 on page 584](#)) to create and manage authentication method objects.

Finding Out More

See [Section 7.5.3 on page 122](#) for an example of how to set up user authentication using a radius server.

38.1.2 Before You Begin

Configure AAA server objects (see [Chapter 37 on page 573](#)) before you configure authentication method objects.

38.1.3 Example: Selecting a VPN Authentication Method

After you set up an authentication method object in the **Auth. Method** screens, you can use it in the **VPN Gateway** screen to authenticate VPN users for establishing a VPN connection. Refer to the chapter on VPN for more information.

Follow the steps below to specify the authentication method for a VPN connection.

- 1 Access the **Configuration > VPN > IPSec VPN > VPN Gateway > Edit** screen.
- 2 Click **Show Advance Setting** and select **Enable Extended Authentication**.

- 3 Select **Server Mode** and select an authentication method object from the drop-down list box.
- 4 Click **OK** to save the settings.

Figure 346 Example: Using Authentication Method in VPN

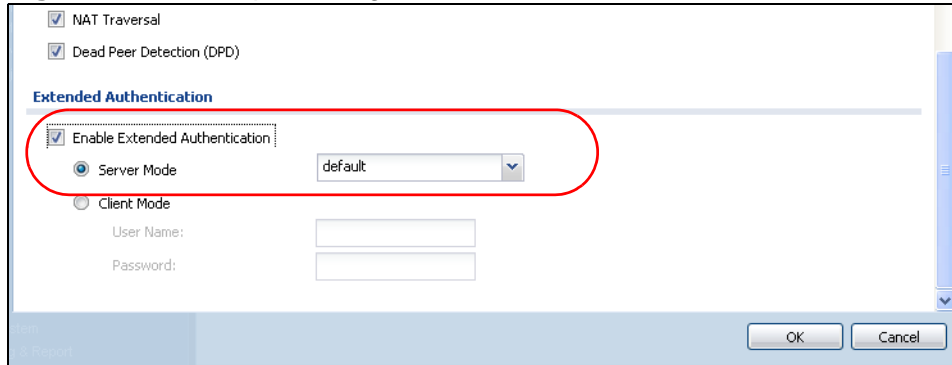

38.2 Authentication Method Objects

Click **Configuration > Object > Auth. Method** to display the screen as shown.

Note: You can create up to 16 authentication method objects.

Figure 347 Configuration > Object > Auth. Method

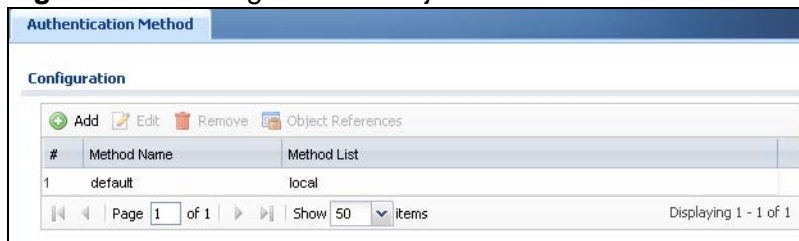

The following table describes the labels in this screen.

Table 175 Configuration > Object > Auth. Method

LABEL	DESCRIPTION
Add	Click this to create a new entry.
Edit	Double-click an entry or select it and click Edit to open a screen where you can modify the entry's settings.
Remove	To remove an entry, select it and click Remove . The ZyWALL confirms you want to remove it before doing so.
Object References	Select an entry and click Object References to open a screen that shows which settings use the entry. See Section 11.3.2 on page 232 for an example.
#	This field displays the index number.
Method Name	This field displays a descriptive name for identification purposes.

Table 175 Configuration > Object > Auth. Method (continued)

LABEL	DESCRIPTION
Method List	This field displays the authentication method(s) for this entry.
Add icon	Click Add to add a new entry. Click Edit to edit the settings of an entry. Click Delete to remove an entry.

38.2.1 Creating an Authentication Method Object

Follow the steps below to create an authentication method object.

- 1 Click **Configuration > Object > Auth. Method**.
- 2 Click **Add**.
- 3 Specify a descriptive name for identification purposes in the **Name** field. You may use 1-31 alphanumeric characters, underscores(_), or dashes (-), but the first character cannot be a number. This value is case-sensitive. For example, "My_Device".
- 4 Click **Add** to insert an authentication method in the table.
- 5 Select a server object from the **Method List** drop-down list box.
- 6 You can add up to four server objects to the table. The ordering of the **Method List** column is important. The ZyWALL authenticates the users using the databases (in the local user database or the external authentication server) in the order they appear in this screen.

If two accounts with the same username exist on two authentication servers you specify, the ZyWALL does not continue the search on the second authentication server when you enter the username and password that doesn't match the one on the first authentication server.

Note: You can NOT select two server objects of the same type.

- Click **OK** to save the settings or click **Cancel** to discard all changes and return to the previous screen.

Figure 348 Configuration > Object > Auth. Method > Add

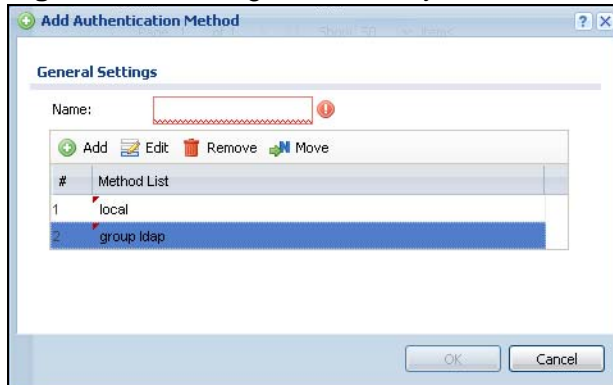

The following table describes the labels in this screen.

Table 176 Configuration > Object > Auth. Method > Add

LABEL	DESCRIPTION
Name	Specify a descriptive name for identification purposes. You may use 1-31 alphanumeric characters, underscores(_), or dashes (-), but the first character cannot be a number. This value is case-sensitive. For example, "My_Device".
Add	Click this to create a new entry. Select an entry and click Add to create a new entry after the selected entry.
Edit	Double-click an entry or select it and click Edit to open a screen where you can modify the entry's settings.
Remove	To remove an entry, select it and click Remove . The ZyWALL confirms you want to remove it before doing so.
Move	To change a method's position in the numbered list, select the method and click Move to display a field to type a number for where you want to put it and press [ENTER] to move the rule to the number that you typed. The ordering of your methods is important as ZyWALL authenticates the users using the authentication methods in the order they appear in this screen.
#	This field displays the index number.
Method List	Select a server object from the drop-down list box. You can create a server object in the AAA Server screen (see Chapter 37 on page 573 for more information). The ZyWALL authenticates the users using the databases (in the local user database or the external authentication server) in the order they appear in this screen. If two accounts with the same username exist on two authentication servers you specify, the ZyWALL does not continue the search on the second authentication server when you enter the username and password that doesn't match the one on the first authentication server.

Table 176 Configuration > Object > Auth. Method > Add (continued)

LABEL	DESCRIPTION
Add icon	Click Add to add a new entry. Click Edit to edit the settings of an entry. Click Delete to delete an entry.
OK	Click OK to save the changes.
Cancel	Click Cancel to discard the changes.

Certificates

39.1 Overview

The ZyWALL can use certificates (also called digital IDs) to authenticate users. Certificates are based on public-private key pairs. A certificate contains the certificate owner's identity and public key. Certificates provide a way to exchange public keys for use in authentication.

39.1.1 What You Can Do in this Chapter

- Use the **My Certificate** screens (see [Section 39.2 on page 593](#) to [Section 39.2.3 on page 602](#)) to generate and export self-signed certificates or certification requests and import the ZyWALL's CA-signed certificates.
- Use the **Trusted Certificates** screens (see [Section 39.3 on page 603](#) to [Section 39.3.2 on page 608](#)) to save CA certificates and trusted remote host certificates to the ZyWALL. The ZyWALL trusts any valid certificate that you have imported as a trusted certificate. It also trusts any valid certificate signed by any of the certificates that you have imported as a trusted certificate.

39.1.2 What You Need to Know

When using public-key cryptology for authentication, each host has two keys. One key is public and can be made openly available. The other key is private and must be kept secure.

These keys work like a handwritten signature (in fact, certificates are often referred to as "digital signatures"). Only you can write your signature exactly as it should look. When people know what your signature looks like, they can verify whether something was signed by you, or by someone else. In the same way, your private key "writes" your digital signature and your public key allows people to verify whether data was signed by you, or by someone else. This process works as follows.

- 1 Tim wants to send a message to Jenny. He needs her to be sure that it comes from him, and that the message content has not been altered by anyone else along the way. Tim generates a public key pair (one public key and one private key).

- 2 Tim keeps the private key and makes the public key openly available. This means that anyone who receives a message seeming to come from Tim can read it and verify whether it is really from him or not.
- 3 Tim uses his private key to sign the message and sends it to Jenny.
- 4 Jenny receives the message and uses Tim's public key to verify it. Jenny knows that the message is from Tim, and that although other people may have been able to read the message, no-one can have altered it (because they cannot re-sign the message with Tim's private key).
- 5 Additionally, Jenny uses her own private key to sign a message and Tim uses Jenny's public key to verify the message.

The ZyWALL uses certificates based on public-key cryptology to authenticate users attempting to establish a connection, not to encrypt the data that you send after establishing a connection. The method used to secure the data that you send through an established connection depends on the type of connection. For example, a VPN tunnel might use the triple DES encryption algorithm.

The certification authority uses its private key to sign certificates. Anyone can then use the certification authority's public key to verify the certificates.

A certification path is the hierarchy of certification authority certificates that validate a certificate. The ZyWALL does not trust a certificate if any certificate on its path has expired or been revoked.

Certification authorities maintain directory servers with databases of valid and revoked certificates. A directory of certificates that have been revoked before the scheduled expiration is called a CRL (Certificate Revocation List). The ZyWALL can check a peer's certificate against a directory server's list of revoked certificates. The framework of servers, software, procedures and policies that handles keys is called PKI (public-key infrastructure).

Advantages of Certificates

Certificates offer the following benefits.

- The ZyWALL only has to store the certificates of the certification authorities that you decide to trust, no matter how many devices you need to authenticate.
- Key distribution is simple and very secure since you can freely distribute public keys and you never need to transmit private keys.

Self-signed Certificates

You can have the ZyWALL act as a certification authority and sign its own certificates.

Factory Default Certificate

The ZyWALL generates its own unique self-signed certificate when you first turn it on. This certificate is referred to in the GUI as the factory default certificate.

Certificate File Formats

Any certificate that you want to import has to be in one of these file formats:

- Binary X.509: This is an ITU-T recommendation that defines the formats for X.509 certificates.
- PEM (Base-64) encoded X.509: This Privacy Enhanced Mail format uses lowercase letters, uppercase letters and numerals to convert a binary X.509 certificate into a printable form.
- Binary PKCS#7: This is a standard that defines the general syntax for data (including digital signatures) that may be encrypted. A PKCS #7 file is used to transfer a public key certificate. The private key is not included. The ZyWALL currently allows the importation of a PKCS#7 file that contains a single certificate.
- PEM (Base-64) encoded PKCS#7: This Privacy Enhanced Mail (PEM) format uses lowercase letters, uppercase letters and numerals to convert a binary PKCS#7 certificate into a printable form.
- Binary PKCS#12: This is a format for transferring public key and private key certificates. The private key in a PKCS #12 file is within a password-encrypted envelope. The file's password is not connected to your certificate's public or private passwords. Exporting a PKCS #12 file creates this and you must provide it to decrypt the contents when you import the file into the ZyWALL.

Note: Be careful not to convert a binary file to text during the transfer process. It is easy for this to occur since many programs use text files by default.

Finding Out More

- See [Section 6.6 on page 103](#) for related information on these screens.
- See [Section 39.4 on page 609](#) for certificate background information.

39.1.3 Verifying a Certificate

Before you import a trusted certificate into the ZyWALL, you should verify that you have the correct certificate. You can do this using the certificate's fingerprint. A certificate's fingerprint is a message digest calculated using the MD5 or SHA1 algorithm. The following procedure describes how to check a certificate's fingerprint to verify that you have the actual certificate.

- 1 Browse to where you have the certificate saved on your computer.

- 2 Make sure that the certificate has a ".cer" or ".crt" file name extension.

Figure 349 Remote Host Certificates

- 3 Double-click the certificate's icon to open the **Certificate** window. Click the **Details** tab and scroll down to the **Thumbprint Algorithm** and **Thumbprint** fields.

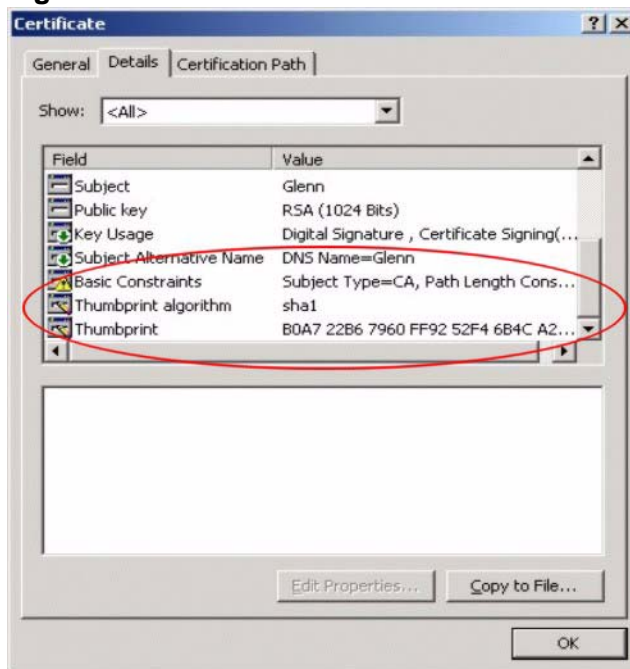
Figure 350 Certificate Details

- 4 Use a secure method to verify that the certificate owner has the same information in the **Thumbprint Algorithm** and **Thumbprint** fields. The secure method may vary based on your situation. Possible examples would be over the telephone or through an HTTPS connection.

39.2 The My Certificates Screen

Click **Configuration > Object > Certificate > My Certificates** to open the **My Certificates** screen. This is the ZyWALL's summary list of certificates and certification requests.

Figure 351 Configuration > Object > Certificate > My Certificates

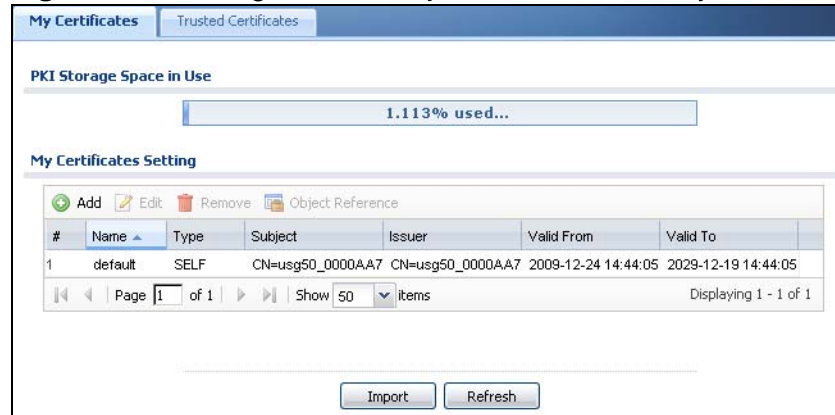

The following table describes the labels in this screen.

Table 177 Configuration > Object > Certificate > My Certificates

LABEL	DESCRIPTION
PKI Storage Space in Use	This bar displays the percentage of the ZyWALL's PKI storage space that is currently in use. When the storage space is almost full, you should consider deleting expired or unnecessary certificates before adding more certificates.
Add	Click this to go to the screen where you can have the ZyWALL generate a certificate or a certification request.
Edit	Double-click an entry or select it and click Edit to open a screen with an in-depth list of information about the certificate.
Remove	The ZyWALL keeps all of your certificates unless you specifically delete them. Uploading a new firmware or default configuration file does not delete your certificates. To remove an entry, select it and click Remove . The ZyWALL confirms you want to remove it before doing so. Subsequent certificates move up by one when you take this action.
Object References	You cannot delete certificates that any of the ZyWALL's features are configured to use. Select an entry and click Object References to open a screen that shows which settings use the entry. See Section 11.3.2 on page 232 for an example.
#	This field displays the certificate index number. The certificates are listed in alphabetical order.
Name	This field displays the name used to identify this certificate. It is recommended that you give each certificate a unique name.

Table 177 Configuration > Object > Certificate > My Certificates (continued)

LABEL	DESCRIPTION
Type	<p>This field displays what kind of certificate this is.</p> <p>REQ represents a certification request and is not yet a valid certificate. Send a certification request to a certification authority, which then issues a certificate. Use the My Certificate Import screen to import the certificate and replace the request.</p> <p>SELF represents a self-signed certificate.</p> <p>CERT represents a certificate issued by a certification authority.</p>
Subject	<p>This field displays identifying information about the certificate's owner, such as CN (Common Name), OU (Organizational Unit or department), O (Organization or company) and C (Country). It is recommended that each certificate have unique subject information.</p>
Issuer	<p>This field displays identifying information about the certificate's issuing certification authority, such as a common name, organizational unit or department, organization or company and country. With self-signed certificates, this is the same information as in the Subject field.</p>
Valid From	<p>This field displays the date that the certificate becomes applicable.</p>
Valid To	<p>This field displays the date that the certificate expires. The text displays in red and includes an Expired! message if the certificate has expired.</p>
Import	<p>Click Import to open a screen where you can save a certificate to the ZyWALL.</p>
Refresh	<p>Click Refresh to display the current validity status of the certificates.</p>

39.2.1 The My Certificates Add Screen

Click **Configuration > Object > Certificate > My Certificates** and then the **Add** icon to open the **My Certificates Add** screen. Use this screen to have the

ZyWALL create a self-signed certificate, enroll a certificate with a certification authority or generate a certification request.

Figure 352 Configuration > Object > Certificate > My Certificates > Add

Add My Certificates

Configuration

Name:

Subject Information

Host IP Address

Host Domain Name

E-Mail

Organizational Unit: (Optional)

Organization: (Optional)

Town(City): (Optional)

State(Province): (Optional)

Country: (Optional)

Key Type: RSA

Key Length: 512 bits

Create a self-signed certificate

Create a certification request and save it locally for later manual enrollment

Create a certification request and enroll for a certificate immediately online

Enrollment Protocol: Certificate Management Protocol(CMP)

CA Server Address:

CA Certificate: test.cer (See [Trusted CAs](#))

Request Authentication

Reference Number:

Key:

OK Cancel

The following table describes the labels in this screen.

Table 178 Configuration > Object > Certificate > My Certificates > Add

LABEL	DESCRIPTION
Name	Type a name to identify this certificate. You can use up to 31 alphanumeric and ;`~!@#\$%^&()_+[]{}',.= - characters.
Subject Information	<p>Use these fields to record information that identifies the owner of the certificate. You do not have to fill in every field, although you must specify a Host IP Address, Host Domain Name, or E-Mail. The certification authority may add fields (such as a serial number) to the subject information when it issues a certificate. It is recommended that each certificate have unique subject information.</p> <p>Select a radio button to identify the certificate's owner by IP address, domain name or e-mail address. Type the IP address (in dotted decimal notation), domain name or e-mail address in the field provided. The domain name or e-mail address is for identification purposes only and can be any string.</p> <p>A domain name can be up to 255 characters. You can use alphanumeric characters, the hyphen and periods.</p> <p>An e-mail address can be up to 63 characters. You can use alphanumeric characters, the hyphen, the @ symbol, periods and the underscore.</p>
Organizational Unit	Identify the organizational unit or department to which the certificate owner belongs. You can use up to 31 characters. You can use alphanumeric characters, the hyphen and the underscore.
Organization	Identify the company or group to which the certificate owner belongs. You can use up to 31 characters. You can use alphanumeric characters, the hyphen and the underscore.
Town (City)	Identify the town or city where the certificate owner is located. You can use up to 31 characters. You can use alphanumeric characters, the hyphen and the underscore.
State, (Province)	Identify the state or province where the certificate owner is located. You can use up to 31 characters. You can use alphanumeric characters, the hyphen and the underscore.
Country	Identify the nation where the certificate owner is located. You can use up to 31 characters. You can use alphanumeric characters, the hyphen and the underscore.
Key Type	<p>Select RSA to use the Rivest, Shamir and Adleman public-key algorithm.</p> <p>Select DSA to use the Digital Signature Algorithm public-key algorithm.</p>
Key Length	Select a number from the drop-down list box to determine how many bits the key should use (512 to 2048). The longer the key, the more secure it is. A longer key also uses more PKI storage space.
Enrollment Options	These radio buttons deal with how and when the certificate is to be generated.
Create a self-signed certificate	Select this to have the ZyWALL generate the certificate and act as the Certification Authority (CA) itself. This way you do not need to apply to a certification authority for certificates.

Table 178 Configuration > Object > Certificate > My Certificates > Add (continued)

LABEL	DESCRIPTION
Create a certification request and save it locally for later manual enrollment	<p>Select this to have the ZyWALL generate and store a request for a certificate. Use the My Certificate Details screen to view the certification request and copy it to send to the certification authority.</p> <p>Copy the certification request from the My Certificate Details screen (see Section 39.2.2 on page 599) and then send it to the certification authority.</p>
Create a certification request and enroll for a certificate immediately online	<p>Select this to have the ZyWALL generate a request for a certificate and apply to a certification authority for a certificate.</p> <p>You must have the certification authority's certificate already imported in the Trusted Certificates screen.</p> <p>When you select this option, you must select the certification authority's enrollment protocol and the certification authority's certificate from the drop-down list boxes and enter the certification authority's server address. You also need to fill in the Reference Number and Key if the certification authority requires them.</p>
Enrollment Protocol	<p>This field applies when you select Create a certification request and enroll for a certificate immediately online. Select the certification authority's enrollment protocol from the drop-down list box.</p> <p>Simple Certificate Enrollment Protocol (SCEP) is a TCP-based enrollment protocol that was developed by VeriSign and Cisco.</p> <p>Certificate Management Protocol (CMP) is a TCP-based enrollment protocol that was developed by the Public Key Infrastructure X.509 working group of the Internet Engineering Task Force (IETF) and is specified in RFC 2510.</p>
CA Server Address	<p>This field applies when you select Create a certification request and enroll for a certificate immediately online. Enter the IP address (or URL) of the certification authority server.</p> <p>For a URL, you can use up to 511 of the following characters. a-zA-Z0-9'()+,/:.=?;!*#@\$_% -</p>
CA Certificate	<p>This field applies when you select Create a certification request and enroll for a certificate immediately online. Select the certification authority's certificate from the CA Certificate drop-down list box.</p> <p>You must have the certification authority's certificate already imported in the Trusted Certificates screen. Click Trusted CAs to go to the Trusted Certificates screen where you can view (and manage) the ZyWALL's list of certificates of trusted certification authorities.</p>

Table 178 Configuration > Object > Certificate > My Certificates > Add (continued)

LABEL	DESCRIPTION
Request Authentication	<p>When you select Create a certification request and enroll for a certificate immediately online, the certification authority may want you to include a reference number and key to identify you when you send a certification request.</p> <p>Fill in both the Reference Number and the Key fields if your certification authority uses the CMP enrollment protocol. Just the Key field displays if your certification authority uses the SCEP enrollment protocol.</p> <p>For the reference number, use 0 to 99999999.</p> <p>For the key, use up to 31 of the following characters. a-zA-Z0-9; `~!@#\$%^&*()_+\\{}';,./<>=-</p>
OK	Click OK to begin certificate or certification request generation.
Cancel	Click Cancel to quit and return to the My Certificates screen.

If you configured the **My Certificate Create** screen to have the ZyWALL enroll a certificate and the certificate enrollment is not successful, you see a screen with a **Return** button that takes you back to the **My Certificate Create** screen. Click **Return** and check your information in the **My Certificate Create** screen. Make sure that the certification authority information is correct and that your Internet connection is working properly if you want the ZyWALL to enroll a certificate online.

The following table describes the labels in this screen.

Table 179 Configuration > Object > Certificate > My Certificates > Edit

LABEL	DESCRIPTION
Name	This field displays the identifying name of this certificate. You can use up to 31 alphanumeric and ;`~!@#\$\$%^&()_+[]{}',.- characters.
Certification Path	<p>This field displays for a certificate, not a certification request.</p> <p>Click the Refresh button to have this read-only text box display the hierarchy of certification authorities that validate the certificate (and the certificate itself).</p> <p>If the issuing certification authority is one that you have imported as a trusted certification authority, it may be the only certification authority in the list (along with the certificate itself). If the certificate is a self-signed certificate, the certificate itself is the only one in the list. The ZyWALL does not trust the certificate and displays "Not trusted" in this field if any certificate on the path has expired or been revoked.</p>
Refresh	Click Refresh to display the certification path.
Certificate Information	These read-only fields display detailed information about the certificate.
Type	This field displays general information about the certificate. CA-signed means that a Certification Authority signed the certificate. Self-signed means that the certificate's owner signed the certificate (not a certification authority). "X.509" means that this certificate was created and signed according to the ITU-T X.509 recommendation that defines the formats for public-key certificates.
Version	This field displays the X.509 version number. "
Serial Number	This field displays the certificate's identification number given by the certification authority or generated by the ZyWALL.
Subject	This field displays information that identifies the owner of the certificate, such as Common Name (CN), Organizational Unit (OU), Organization (O), State (ST), and Country (C).
Issuer	<p>This field displays identifying information about the certificate's issuing certification authority, such as Common Name, Organizational Unit, Organization and Country.</p> <p>With self-signed certificates, this is the same as the Subject Name field.</p> <p>"none" displays for a certification request.</p>
Signature Algorithm	This field displays the type of algorithm that was used to sign the certificate. The ZyWALL uses rsa-pkcs1-sha1 (RSA public-private key encryption algorithm and the SHA1 hash algorithm). Some certification authorities may use rsa-pkcs1-md5 (RSA public-private key encryption algorithm and the MD5 hash algorithm).
Valid From	This field displays the date that the certificate becomes applicable. "none" displays for a certification request.
Valid To	This field displays the date that the certificate expires. The text displays in red and includes an Expired! message if the certificate has expired. "none" displays for a certification request.

Table 179 Configuration > Object > Certificate > My Certificates > Edit

LABEL	DESCRIPTION
Key Algorithm	This field displays the type of algorithm that was used to generate the certificate's key pair (the ZyWALL uses RSA encryption) and the length of the key set in bits (1024 bits for example).
Subject Alternative Name	This field displays the certificate owner's IP address (IP), domain name (DNS) or e-mail address (EMAIL).
Key Usage	This field displays for what functions the certificate's key can be used. For example, "DigitalSignature" means that the key can be used to sign certificates and "KeyEncipherment" means that the key can be used to encrypt text.
Basic Constraint	This field displays general information about the certificate. For example, Subject Type=CA means that this is a certification authority's certificate and "Path Length Constraint=1" means that there can only be one certification authority in the certificate's path. This field does not display for a certification request.
MD5 Fingerprint	This is the certificate's message digest that the ZyWALL calculated using the MD5 algorithm.
SHA1 Fingerprint	This is the certificate's message digest that the ZyWALL calculated using the SHA1 algorithm.
Certificate in PEM (Base-64) Encoded Format	<p>This read-only text box displays the certificate or certification request in Privacy Enhanced Mail (PEM) format. PEM uses lowercase letters, uppercase letters and numerals to convert a binary certificate into a printable form.</p> <p>You can copy and paste a certification request into a certification authority's web page, an e-mail that you send to the certification authority or a text editor and save the file on a management computer for later manual enrollment.</p> <p>You can copy and paste a certificate into an e-mail to send to friends or colleagues or you can copy and paste a certificate into a text editor and save the file on a management computer for later distribution (via floppy disk for example).</p>
Export	This button displays for a certification request. Use this button to save a copy of the request without its private key. Click this button and then Save in the File Download screen. The Save As screen opens, browse to the location that you want to use and click Save .
Export Certificate Only	Use this button to save a copy of the certificate without its private key. Click this button and then Save in the File Download screen. The Save As screen opens, browse to the location that you want to use and click Save .
Password	If you want to export the certificate with its private key, create a password and type it here. Make sure you keep this password in a safe place. You will need to use it if you import the certificate to another device.
Export Certificate with Private Key	Use this button to save a copy of the certificate with its private key. Type the certificate's password and click this button. Click Save in the File Download screen. The Save As screen opens, browse to the location that you want to use and click Save .

Table 179 Configuration > Object > Certificate > My Certificates > Edit

LABEL	DESCRIPTION
OK	Click OK to save your changes back to the ZyWALL. You can only change the name.
Cancel	Click Cancel to quit and return to the My Certificates screen.

39.2.3 The My Certificates Import Screen

Click **Configuration > Object > Certificate > My Certificates > Import** to open the **My Certificate Import** screen. Follow the instructions in this screen to save an existing certificate to the ZyWALL.

Note: You can import a certificate that matches a corresponding certification request that was generated by the ZyWALL. You can also import a certificate in PKCS#12 format, including the certificate's public and private keys.

The certificate you import replaces the corresponding request in the **My Certificates** screen.

You must remove any spaces from the certificate's filename before you can import it.

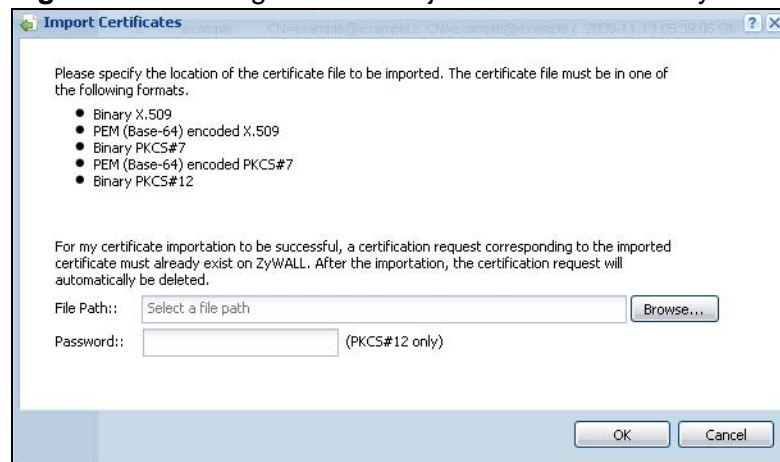
Figure 354 Configuration > Object > Certificate > My Certificates > Import

The following table describes the labels in this screen.

Table 180 Configuration > Object > Certificate > My Certificates > Import

LABEL	DESCRIPTION
File Path	Type in the location of the file you want to upload in this field or click Browse to find it. You cannot import a certificate with the same name as a certificate that is already in the ZyWALL.
Browse	Click Browse to find the certificate file you want to upload.

Table 180 Configuration > Object > Certificate > My Certificates > Import (continued)

LABEL	DESCRIPTION
Password	This field only applies when you import a binary PKCS#12 format file. Type the file's password that was created when the PKCS #12 file was exported.
OK	Click OK to save the certificate on the ZyWALL.
Cancel	Click Cancel to quit and return to the My Certificates screen.

39.3 The Trusted Certificates Screen

Click **Configuration > Object > Certificate > Trusted Certificates** to open the **Trusted Certificates** screen. This screen displays a summary list of certificates that you have set the ZyWALL to accept as trusted. The ZyWALL also accepts any valid certificate signed by a certificate on this list as being trustworthy; thus you do not need to import any certificate that is signed by one of these certificates.

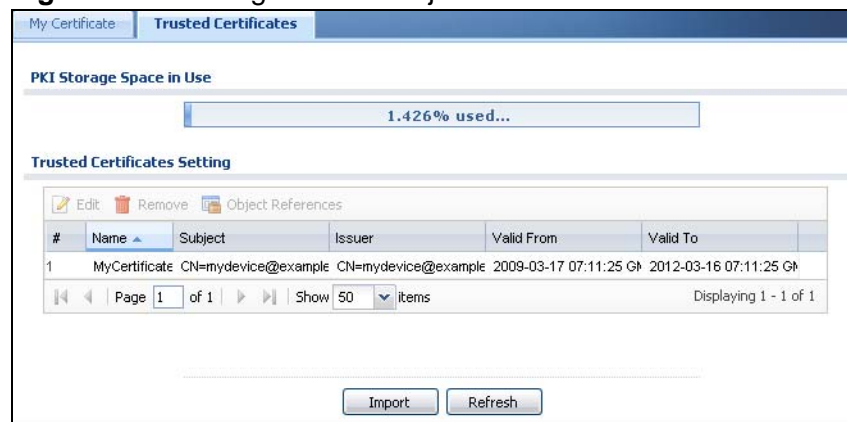
Figure 355 Configuration > Object > Certificate > Trusted Certificates

The following table describes the labels in this screen.

Table 181 Configuration > Object > Certificate > Trusted Certificates

LABEL	DESCRIPTION
PKI Storage Space in Use	This bar displays the percentage of the ZyWALL's PKI storage space that is currently in use. When the storage space is almost full, you should consider deleting expired or unnecessary certificates before adding more certificates.
Edit	Double-click an entry or select it and click Edit to open a screen with an in-depth list of information about the certificate.
Remove	The ZyWALL keeps all of your certificates unless you specifically delete them. Uploading a new firmware or default configuration file does not delete your certificates. To remove an entry, select it and click Remove . The ZyWALL confirms you want to remove it before doing so. Subsequent certificates move up by one when you take this action.

Table 181 Configuration > Object > Certificate > Trusted Certificates (continued)

LABEL	DESCRIPTION
Object References	You cannot delete certificates that any of the ZyWALL's features are configured to use. Select an entry and click Object References to open a screen that shows which settings use the entry. See Section 11.3.2 on page 232 for an example.
#	This field displays the certificate index number. The certificates are listed in alphabetical order.
Name	This field displays the name used to identify this certificate.
Subject	This field displays identifying information about the certificate's owner, such as CN (Common Name), OU (Organizational Unit or department), O (Organization or company) and C (Country). It is recommended that each certificate have unique subject information.
Issuer	This field displays identifying information about the certificate's issuing certification authority, such as a common name, organizational unit or department, organization or company and country. With self-signed certificates, this is the same information as in the Subject field.
Valid From	This field displays the date that the certificate becomes applicable.
Valid To	This field displays the date that the certificate expires. The text displays in red and includes an Expired! message if the certificate has expired.
Import	Click Import to open a screen where you can save the certificate of a certification authority that you trust, from your computer to the ZyWALL.
Refresh	Click this button to display the current validity status of the certificates.

39.3.1 The Trusted Certificates Edit Screen

Click **Configuration > Object > Certificate > Trusted Certificates** and then a certificate's **Edit** icon to open the **Trusted Certificates Edit** screen. Use this screen to view in-depth information about the certificate, change the certificate's name and set whether or not you want the ZyWALL to check a certification

The following table describes the labels in this screen.

Table 182 Configuration > Object > Certificate > Trusted Certificates > Edit

LABEL	DESCRIPTION
Name	This field displays the identifying name of this certificate. You can change the name. You can use up to 31 alphanumeric and ;~!@#\$\$%^&()_+[]{}',=- characters.
Certification Path	Click the Refresh button to have this read-only text box display the end entity's certificate and a list of certification authority certificates that shows the hierarchy of certification authorities that validate the end entity's certificate. If the issuing certification authority is one that you have imported as a trusted certificate, it may be the only certification authority in the list (along with the end entity's own certificate). The ZyWALL does not trust the end entity's certificate and displays "Not trusted" in this field if any certificate on the path has expired or been revoked.
Refresh	Click Refresh to display the certification path.
Enable X.509v3 CRL Distribution Points and OCSP checking	Select this check box to have the ZyWALL check incoming certificates that are signed by this certificate against a Certificate Revocation List (CRL) or an OCSP server. You also need to configure the OCSP or LDAP server details.
OCSP Server	Select this check box if the directory server uses OCSP (Online Certificate Status Protocol).
URL	Type the protocol, IP address and pathname of the OCSP server.
ID	The ZyWALL may need to authenticate itself in order to assess the OCSP server. Type the login name (up to 31 ASCII characters) from the entity maintaining the server (usually a certification authority).
Password	Type the password (up to 31 ASCII characters) from the entity maintaining the OCSP server (usually a certification authority).
LDAP Server	Select this check box if the directory server uses LDAP (Lightweight Directory Access Protocol). LDAP is a protocol over TCP that specifies how clients access directories of certificates and lists of revoked certificates.
Address	Type the IP address (in dotted decimal notation) of the directory server.
Port	Use this field to specify the LDAP server port number. You must use the same server port number that the directory server uses. 389 is the default server port number for LDAP.
ID	The ZyWALL may need to authenticate itself in order to assess the CRL directory server. Type the login name (up to 31 ASCII characters) from the entity maintaining the server (usually a certification authority).
Password	Type the password (up to 31 ASCII characters) from the entity maintaining the CRL directory server (usually a certification authority).
Certificate Information	These read-only fields display detailed information about the certificate.

Table 182 Configuration > Object > Certificate > Trusted Certificates > Edit

LABEL	DESCRIPTION
Type	This field displays general information about the certificate. CA-signed means that a Certification Authority signed the certificate. Self-signed means that the certificate's owner signed the certificate (not a certification authority). X.509 means that this certificate was created and signed according to the ITU-T X.509 recommendation that defines the formats for public-key certificates.
Version	This field displays the X.509 version number.
Serial Number	This field displays the certificate's identification number given by the certification authority.
Subject	This field displays information that identifies the owner of the certificate, such as Common Name (CN), Organizational Unit (OU), Organization (O) and Country (C).
Issuer	This field displays identifying information about the certificate's issuing certification authority, such as Common Name, Organizational Unit, Organization and Country. With self-signed certificates, this is the same information as in the Subject Name field.
Signature Algorithm	This field displays the type of algorithm that was used to sign the certificate. Some certification authorities use rsa-pkcs1-sha1 (RSA public-private key encryption algorithm and the SHA1 hash algorithm). Other certification authorities may use rsa-pkcs1-md5 (RSA public-private key encryption algorithm and the MD5 hash algorithm).
Valid From	This field displays the date that the certificate becomes applicable. The text displays in red and includes a Not Yet Valid! message if the certificate has not yet become applicable.
Valid To	This field displays the date that the certificate expires. The text displays in red and includes an Expiring! or Expired! message if the certificate is about to expire or has already expired.
Key Algorithm	This field displays the type of algorithm that was used to generate the certificate's key pair (the ZyWALL uses RSA encryption) and the length of the key set in bits (1024 bits for example).
Subject Alternative Name	This field displays the certificate's owner's IP address (IP), domain name (DNS) or e-mail address (EMAIL).
Key Usage	This field displays for what functions the certificate's key can be used. For example, "DigitalSignature" means that the key can be used to sign certificates and "KeyEncipherment" means that the key can be used to encrypt text.
Basic Constraint	This field displays general information about the certificate. For example, Subject Type=CA means that this is a certification authority's certificate and "Path Length Constraint=1" means that there can only be one certification authority in the certificate's path.
MD5 Fingerprint	This is the certificate's message digest that the ZyWALL calculated using the MD5 algorithm. You can use this value to verify with the certification authority (over the phone for example) that this is actually their certificate.

Table 182 Configuration > Object > Certificate > Trusted Certificates > Edit

LABEL	DESCRIPTION
SHA1 Fingerprint	This is the certificate's message digest that the ZyWALL calculated using the SHA1 algorithm. You can use this value to verify with the certification authority (over the phone for example) that this is actually their certificate.
Certificate in PEM (Base-64) Encoded Format	This read-only text box displays the certificate or certification request in Privacy Enhanced Mail (PEM) format. PEM uses lowercase letters, uppercase letters and numerals to convert a binary certificate into a printable form. You can copy and paste the certificate into an e-mail to send to friends or colleagues or you can copy and paste the certificate into a text editor and save the file on a management computer for later distribution (via floppy disk for example).
Export Certificate	Click this button and then Save in the File Download screen. The Save As screen opens, browse to the location that you want to use and click Save .
OK	Click OK to save your changes back to the ZyWALL. You can only change the name.
Cancel	Click Cancel to quit and return to the Trusted Certificates screen.

39.3.2 The Trusted Certificates Import Screen

Click **Configuration > Object > Certificate > Trusted Certificates > Import** to open the **Trusted Certificates Import** screen. Follow the instructions in this screen to save a trusted certificate to the ZyWALL.

Note: You must remove any spaces from the certificate's filename before you can import the certificate.

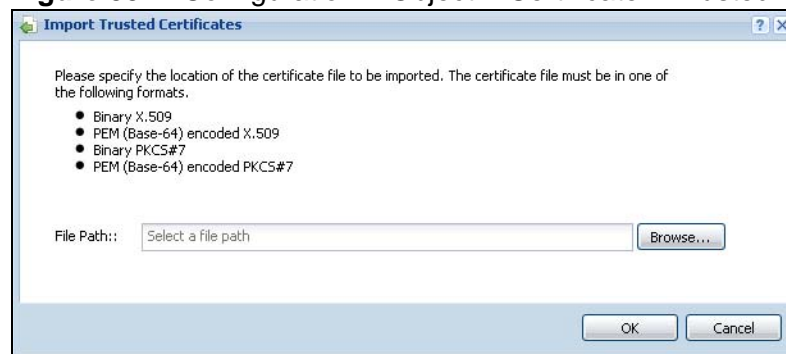
Figure 357 Configuration > Object > Certificate > Trusted Certificates > Import

The following table describes the labels in this screen.

Table 183 Configuration > Object > Certificate > Trusted Certificates > Import

LABEL	DESCRIPTION
File Path	Type in the location of the file you want to upload in this field or click Browse to find it. You cannot import a certificate with the same name as a certificate that is already in the ZyWALL.
Browse	Click Browse to find the certificate file you want to upload.
OK	Click OK to save the certificate on the ZyWALL.
Cancel	Click Cancel to quit and return to the previous screen.

39.4 Certificates Technical Reference

OCSP

OCSP (Online Certificate Status Protocol) allows an application or device to check whether a certificate is valid. With OCSP the ZyWALL checks the status of individual certificates instead of downloading a Certificate Revocation List (CRL). OCSP has two main advantages over a CRL. The first is real-time status information. The second is a reduction in network traffic since the ZyWALL only gets information on the certificates that it needs to verify, not a huge list. When the ZyWALL requests certificate status information, the OCSP server returns a "expired", "current" or "unknown" response.

ISP Accounts

40.1 Overview

Use ISP accounts to manage Internet Service Provider (ISP) account information for PPPoE/PPTP interfaces. An ISP account is a profile of settings for Internet access using PPPoE or PPTP.

Finding Out More

- See [Section 11.4 on page 233](#) for information about PPPoE/PPTP interfaces.
- See [Section 6.6 on page 103](#) for related information on these screens.

40.1.1 What You Can Do in this Chapter

Use the **Object > ISP Account** screens ([Section 40.2 on page 611](#)) to create and manage ISP accounts in the ZyWALL.

40.2 ISP Account Summary

This screen provides a summary of ISP accounts in the ZyWALL. To access this screen, click **Configuration > Object > ISP Account**.

Figure 358 Configuration > Object > ISP Account

#	Profile Name	Protocol	Authentication Type	User Name
1	some-ISP	pppoe	chap-pap	test

The following table describes the labels in this screen. See [the ISP Account Edit section](#) below for more information as well.

Table 184 Configuration > Object > ISP Account

LABEL	DESCRIPTION
Add	Click this to create a new entry.
Edit	Double-click an entry or select it and click Edit to be able to modify the entry's settings.
Remove	To remove an entry, select it and click Remove . The ZyWALL confirms you want to remove it before doing so.
Object References	Select an entry and click Object References to open a screen that shows which settings use the entry. See Section 11.3.2 on page 232 for an example.
#	This field is a sequential value, and it is not associated with a specific entry.
Profile Name	This field displays the profile name of the ISP account. This name is used to identify the ISP account.
Protocol	This field displays the protocol used by the ISP account.
Authentication Type	This field displays the authentication type used by the ISP account.
User Name	This field displays the user name of the ISP account.

40.2.1 ISP Account Edit

The **ISP Account Edit** screen lets you add information about new accounts and edit information about existing accounts. To open this window, open the **ISP Account** screen. (See [Section 40.2 on page 611](#).) Then, click on an **Add** icon or **Edit** icon to open the **ISP Account Edit** screen below.

Figure 359 Configuration > Object > ISP Account > Edit

The following table describes the labels in this screen.

Table 185 Configuration > Object > ISP Account > Edit

LABEL	DESCRIPTION
Profile Name	This field is read-only if you are editing an existing account. Type in the profile name of the ISP account. The profile name is used to refer to the ISP account. You may use 1-31 alphanumeric characters, underscores(_), or dashes (-), but the first character cannot be a number. This value is case-sensitive.
Protocol	This field is read-only if you are editing an existing account. Select the protocol used by the ISP account. Options are: pppoe - This ISP account uses the PPPoE protocol. pptp - This ISP account uses the PPTP protocol.
Authentication Type	Use the drop-down list box to select an authentication protocol for outgoing calls. Options are: CHAP/PAP - Your ZyWALL accepts either CHAP or PAP when requested by this remote node. CHAP - Your ZyWALL accepts CHAP only. PAP - Your ZyWALL accepts PAP only. MSCHAP - Your ZyWALL accepts MSCHAP only. MSCHAP-V2 - Your ZyWALL accepts MSCHAP-V2 only.
Encryption Method	This field is available if this ISP account uses the PPTP protocol. Use the drop-down list box to select the type of Microsoft Point-to-Point Encryption (MPPE). Options are: nomppe - This ISP account does not use MPPE. mppe-40 - This ISP account uses 40-bit MPPE. mppe-128 - This ISP account uses 128-bit MMPE.
User Name	Type the user name given to you by your ISP.
Password	Type the password associated with the user name above. The password can only consist of alphanumeric characters (A-Z, a-z, 0-9). This field can be blank.
Retype to Confirm	Type your password again to make sure that you have entered is correctly.
Server IP	If this ISP account uses the PPPoE protocol, this field is not displayed. If this ISP account uses the PPTP protocol, type the IP address of the PPTP server.
Connection ID	This field is available if this ISP account uses the PPTP protocol. Type your identification name for the PPTP server. This field can be blank.
Service Name	If this ISP account uses the PPPoE protocol, type the PPPoE service name to access. PPPoE uses the specified service name to identify and reach the PPPoE server. This field can be blank. If this ISP account uses the PPTP protocol, this field is not displayed.

Table 185 Configuration > Object > ISP Account > Edit (continued)

LABEL	DESCRIPTION
Compression	Select On button to turn on stac compression, and select Off to turn off stac compression. Stac compression is a data compression technique capable of compressing data by a factor of about four.
Idle Timeout	This value specifies the number of seconds that must elapse without outbound traffic before the ZyWALL automatically disconnects from the PPPoE/PPTP server. This value must be an integer between 0 and 360. If this value is zero, this timeout is disabled.
OK	Click OK to save your changes back to the ZyWALL. If there are no errors, the program returns to the ISP Account screen. If there are errors, a message box explains the error, and the program stays in the ISP Account Edit screen.
Cancel	Click Cancel to return to the ISP Account screen without creating the profile (if it is new) or saving any changes to the profile (if it already exists).

SSL Application

41.1 Overview

You use SSL application objects in SSL VPN. Configure an SSL application object to specify the type of application and the address of the local computer, server, or web site SSL users are to be able to access. You can apply one or more SSL application objects in the **VPN > SSL VPN** screen for a user account/user group.

41.1.1 What You Can Do in this Chapter

- Use the **SSL Application** screen ([Section 41.2 on page 617](#)) to view the ZyWALL's configured SSL application objects.
- Use the **SSL Application Edit** screen to create or edit web-based application objects to allow remote users to access an application via standard web browsers ([Section 41.2.1 on page 618](#)).
- You can also use the **SSL Application Edit** screen to specify the name of a folder on a Linux or Windows file server which remote users can access using a standard web browser ([Section 41.2.1 on page 618](#)).

41.1.2 What You Need to Know

Application Types

You can configure the following SSL application on the ZyWALL.

- **Web-based**
A web-based application allows remote users to access an intranet site using standard web browsers.

Remote User Screen Links

Available SSL application names are displayed as links in remote user screens. Depending on the application type, remote users can simply click the links or follow the steps in the pop-up dialog box to access.

Remote Desktop Connections

Use SSL VPN to allow remote users to manage LAN computers. Depending on the functions supported by the remote desktop software, they can install or remove software, run programs, change settings, and open, copy, create, and delete files. This is useful for troubleshooting, support, administration, and remote access to files and programs.

The LAN computer to be managed must have VNC (Virtual Network Computing) or RDP (Remote Desktop Protocol) server software installed. The remote user's computer does not use VNC or RDP client software. The ZyWALL works with the following remote desktop connection software:

RDP

- Windows Remote Desktop (supported in Internet Explorer)

VNC

- RealVNC
- TightVNC
- UltraVNC

For example, user A uses an SSL VPN connection to log into the ZyWALL. Then he manages LAN computer B which has RealVNC server software installed.

Figure 360 SSL-protected Remote Management

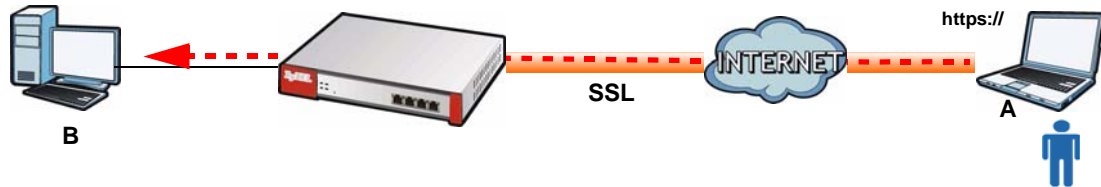

Weblinks

You can configure weblink SSL applications to allow remote users to access web sites.

41.1.3 Example: Specifying a Web Site for Access

This example shows you how to create a web-based application for an internal web site. The address of the web site is `http://info` with web page encryption.

- 1 Click **Configuration > Object > SSL Application** in the navigation panel.

- Click the **Add** button and select **Web Application** in the **Type** field.

In the **Server Type** field, select **Web Server**.

Enter a descriptive name in the **Display Name** field. For example, "CompanyIntranet".

In the **Address** field, enter "http://info".

Select **Web Page Encryption** to prevent users from saving the web content.

Click **Apply** to save the settings.

The configuration screen should look similar to the following figure.

Figure 361 Example: SSL Application: Specifying a Web Site for Access

The screenshot shows a dialog box titled "Add SSL Application". It has a "Create new Object" dropdown at the top. Below is the "Object" section with a "Type" dropdown set to "Web Application". Underneath is the "Web Application" section with fields for "Server Type" (set to "Web Server"), "Name" (set to "WebExample"), "URL" (set to "http://info"), and "Entry Point" (empty, with "(Optional)" text). There is a checked checkbox for "Web Page Encryption". At the bottom right are "OK" and "Cancel" buttons.

41.2 The SSL Application Screen

The main **SSL Application** screen displays a list of the configured SSL application objects. Click **Configuration > Object > SSL Application** in the navigation panel.

Figure 362 Configuration > Object > SSL Application

The screenshot shows the "SSL Application" configuration screen. It has a "Configuration" section with a table of SSL application objects. The table has columns for "#", "Name", "Address", and "Type". Below the table are navigation controls for page and item count.

#	Name	Address	Type
1	FileSharing_1	\example\example_1	file-sharing
2	OWA-example	http://mail.example	owa
3	VNC_Server1	DMZ2_SUBNET:5900-5900	vnc
4	WebExample	http://info	web-server
5	WebLink-Example	http://example.com	weblink

Navigation controls: Page 1 of 1, Show 50 items, Displaying 1 - 5 of 5

The following table describes the labels in this screen.

Table 186 Configuration > Object > SSL Application

LABEL	DESCRIPTION
Add	Click this to create a new entry.
Edit	Double-click an entry or select it and click Edit to be able to modify the entry's settings.
Remove	To remove an entry, select it and click Remove . The ZyWALL confirms you want to remove it before doing so.
Object Reference s	Select an entry and click Object References to open a screen that shows which settings use the entry. See Section 11.3.2 on page 232 for an example.
#	This field displays the index number.
Name	This field displays the name of the object.
Address	This field displays the IP address/URL of the application server or the location of a file share.
Type	This field shows whether the object is a file-sharing, web-server, Outlook Web Access, Virtual Network Computing, or Remote Desktop Protocol SSL application.

41.2.1 Creating/Editing a Web-based SSL Application Object

A web-based application allows remote users to access an application via standard web browsers.

To configure a web-based application, click the **Add** or **Edit** button in the **SSL Application** screen and select **Web Application** in the **Type** field to display the configuration screen as shown.

Figure 363 Configuration > Object > SSL Application > Add/Edit: Web Application

The following table describes the labels in this screen.

Table 187 Configuration > Object > SSL Application > Add/Edit: Web Application

LABEL	DESCRIPTION
Show Advance Settings / Hide Advance Settings	This displays for VNC or RDP type web application objects. Click this button to display a greater or lesser number of configuration fields.
Create new Object	Use this to configure any new settings objects that you need to use in this screen.
Object	
Type	Select Web Application from the drop-down list box.
Web Application	Click Advanced to display more configuration fields and edit the details of your SSL application setup. Click Basic to display fewer fields.
Server Type	<p>Specify the type of service for this SSL application.</p> <p>Select Web Server to allow access to the specified web site hosted on the local network.</p> <p>Select OWA (Outlook Web Access) to allow users to access e-mails, contacts, calendars via Microsoft Outlook-like interface using supported web browsers. The ZyWALL supports one OWA object.</p> <p>Select VNC to allow users to manage LAN computers that have Virtual Network Computing remote desktop server software installed.</p> <p>Select RDP to allow users to manage LAN computers that have Remote Desktop Protocol remote desktop server software installed.</p> <p>Select Weblink to create a link to a web site that you expect the SSL VPN users to commonly use.</p>
Name	Enter a descriptive name to identify this object. You can enter up to 31 characters ("0-9", "a-z", "A-Z", "-" and "_"). Spaces are not allowed.
URL	<p>This field displays if the Server Type is set to Web Server, OWA, or Weblink.</p> <p>Enter the Fully-Qualified Domain Name (FQDN) or IP address of the application server.</p> <p>Note: You must enter the "http://" or "https://" prefix.</p> <p>Remote users are restricted to access only files in this directory. For example, if you enter "\\remote\" in this field, remote users can only access files in the "remote" directory.</p> <p>If a link contains a file that is not within this domain, then remote users cannot access it.</p>
Preview	<p>This field displays if the Server Type is set to Web Server, OWA or Weblink.</p> <p>Click Preview to access the URL you specified in a new IE web browser.</p>

Table 187 Configuration > Object > SSL Application > Add/Edit: Web Application

LABEL	DESCRIPTION
Entry Point	<p>This field displays if the Server Type is set to Web Server or OWA.</p> <p>This field is optional. You only need to configure this field if you need to specify the name of the directory or file on the local server as the home page or home directory on the user screen.</p>
Server Address(es)	<p>This field displays if the Server Type is set to RDP or VNC.</p> <p>Specify the IP address or Fully-Qualified Domain Name (FQDN) of the computer(s) that you want to allow the remote users to manage.</p>
Starting Port Ending Port	<p>This field displays if the Server Type is set to RDP or VNC.</p> <p>Specify the listening ports of the LAN computer(s) running remote desktop server software. The ZyWALL uses a port number from this range to send traffic to the LAN computer that is being remotely managed.</p>
Program Path	<p>This field displays if the Server Type is set to RDP.</p> <p>You can specify an application to open when a remote user logs into the remote desktop application.</p>
Web Page Encryption	<p>Select this option to prevent users from saving the web content.</p>
Ok	<p>Click Ok to save the changes and return to the main SSL Application Configuration screen.</p>
Cancel	<p>Click Cancel to discard the changes and return to the main SSL Application Configuration screen.</p>

Endpoint Security

42.1 Overview

Use Endpoint Security (EPS), also known as endpoint control, to make sure users' computers comply with defined corporate policies before they can access the network or an SSL VPN tunnel. After a successful user authentication, a user's computer must meet the endpoint security object's Operating System (OS) option and security requirements to gain access. You can configure the endpoint security object to require a user's computer to match just one of the endpoint security object's checking criteria or all of them. Configure endpoint security objects to use with the authentication policy and SSL VPN features.

For example, an authentication policy could use an endpoint security object that requires a LAN user's computer to pass all of the object's checking items in order to access the network. LAN user **A** passes all of the checks and is given access. An SSL VPN tunnel could use a different endpoint security profile that only requires the user's computer to match at least one checked item. SSL VPN user **B** matches at least one of the items checked by the SSL VPN's endpoint security object and is granted access to the system resource defined in the SSL VPN access policy; in this example a web server. SSL VPN user **C** fails all of the SSL VPN's endpoint security check and is not given any access.

Figure 364 Endpoint Security

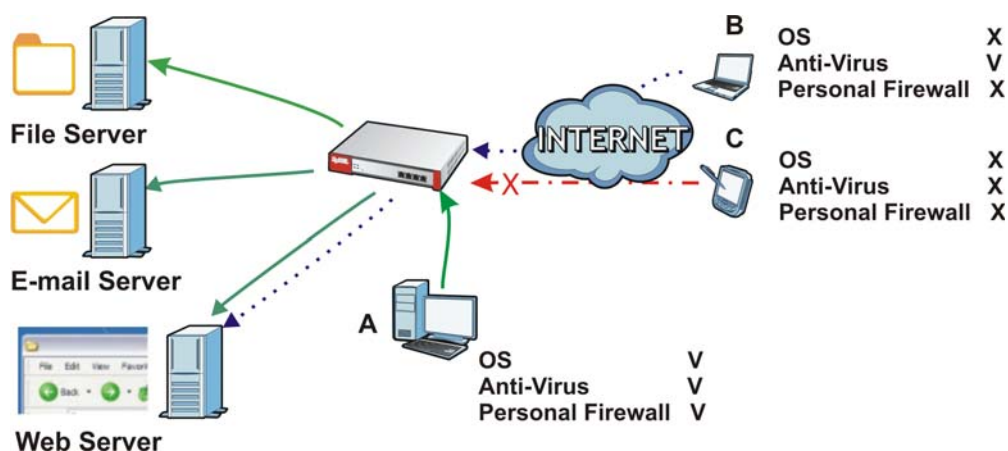

42.1.1 What You Can Do in this Chapter

Use the **Configuration > Object > Endpoint Security** screens ([Section 42.2 on page 623](#)) to create and manage endpoint security objects.

42.1.2 What You Need to Know

What Endpoint Security Can Check

The settings endpoint security can check vary depending on the OS of the user's computer. Depending on the OS, EPS can check user computers for the following:

- Windows Auto Update setting
- Installed security patches
- Personal firewall installation and activation
- Anti-virus installation and activation
- Windows registry settings
- Processes that the endpoint must execute
- Processes that the endpoint cannot execute
- The size and version of specific files

Multiple Endpoint Security Objects

You can configure an authentication policy or SSL VPN policy to use multiple endpoint security objects. This allows checking of computers with different OSs or security settings. When a client attempts to log in, the ZyWALL checks the client's computer against the endpoint security objects one-by-one. The client's computer must match one of the force authentication or SSL VPN policy's endpoint security objects in order to gain access.

Requirements

User computers must have Sun's Java (Java Runtime Environment or 'JRE') installed and enabled with a minimum version of 1.4.

Finding Out More

See [Section 7.7 on page 126](#) for an example of how to use endpoint security and authentication policies.

42.2 Endpoint Security Screen

The **Endpoint Security** screen displays the endpoint security objects you have configured on the ZyWALL.

Click **Configuration > Object > Endpoint Security** to display the screen.

Figure 365 Configuration > Object > Endpoint Security

The following table gives an overview of the objects you can configure.

Table 188 Configuration > Object > Endpoint Security

LABEL	DESCRIPTION
Add	Click this to create a new entry.
Edit	Double-click an entry or select it and click Edit to open a screen where you can modify the entry's settings.
Remove	To remove an entry, select it and click Remove . The ZyWALL confirms you want to remove it before doing so.
Object References	Select an entry and click Object References to open a screen that shows which settings use the object. See Section 11.3.2 on page 232 for an example.
Object Name	This field displays the descriptive name that identifies this object.
Description	If the entry has a description configured, it displays here.
Endpoint Operating System	This is the type of operating system that the user's computer must be using.
Checking Failure Message	Enter a message to display when a user's computer fails the endpoint security check. Use up to 1023 characters (0-9a-zA-Z;/?:@=+\$\._!*'()%,"). For example, "Endpoint Security checking failed. Please contact your network administrator for help."

Table 188 Configuration > Object > Endpoint Security (continued)

LABEL	DESCRIPTION
Apply	Click this button to save your changes to the ZyWALL.
Reset	Click this button to return the screen to its last-saved settings.

42.3 Endpoint Security Add/Edit

Click **Configuration > Object > Endpoint Security** and then the **Add** (or **Edit**) icon to open the **Endpoint Security Edit** screen. Use this screen to configure an endpoint security object.

Figure 366 Configuration > Object > Endpoint Security > Add

Add EPS

Hide Advanced Settings

General Settings

Object Name:

Description:

Endpoint Operating System: Windows

Window Version: Windows 2000

Endpoint must update to Windows Service Pack: (ex: 2 for at least SP2 update, blank for don't care)

Passing Criterion

Endpoint must comply with all checking items

Endpoint must comply with at least one checking item

Note:
If you do not select any checking items, the endpoints only need to be using the selected operating system.

Checking Item - Windows Update

Windows Update Settings

Endpoint must enable Windows Auto Update

Checking Item - Security Patch

Required Windows Security Patches on Endpoints

#	Windows Security Patch
1	Windows Security Patch

Page 1 of 1 Show 50 items No data to display

Endpoint needs to match all of the windows security patch

Example:
"Windows Security Patch* : KB5682

Checking Item - Personal Firewall

Endpoint must have Personal Firewall installed

Available

- Kaspersky_Internet_Security_v2009
- Kaspersky_Internet_Security_v2010
- Microsoft_Security_Center
- TrendMicro_PC-cillin_Internet_Security_Pro_v2010
- TrendMicro_PC-cillin_Internet_Security_v2010
- Windows_Firewall

Allowed Personal Firewall List

Endpoint needs to match any of the personal firewall

Checking Item - Anti-Virus Software

Endpoint must have Anti-Virus software installed

Available

- Avira_Antivir_Personal_v2009
- Kaspersky_Anti-Virus_v2009
- Kaspersky_Anti-Virus_v2010
- Kaspersky_Internet_Security_v2009
- Kaspersky_Internet_Security_v2010

Allowed Anti-Virus Software List

Checking Item - Windows Registry

+ Add - Remove

#	Windows Registry Name	Operation	Windows Registry Value
No data to display			

Endpoint needs to match all of the windows registry

Example:
 "Windows Registry Name": HKEY_LOCAL_MACHINE\SOFTWARE\Microsoft\Internet Explorer\Build
 "Windows Registry Value": 62900.21

Checking Item - Required Processes

Processes Endpoints Must Have Running

+ Add - Remove

#	Trusted Process
No data to display	

Endpoint needs to match all of trusted process

Note:
 Filename extension is unnecessary on process check when OS type is "Windows".

Checking Item - Forbidden Processes

Processes Endpoints Must NOT Have Running

+ Add - Remove

#	Forbidden Process
No data to display	

Endpoint needs to unmatch all of forbidden process

Note:
 Filename extension is unnecessary on process check when OS type is "Windows".

Checking Item - File Information

+ Add - Remove

#	File Path	Operation	File Size	Operation	File Version
No data to display					

Endpoint needs to match any of the selected files

Example:
 "File Path": C:\Program Files\Internet Explorer\explore.exe
 "File Size": 1-1073741824 bytes
 "File Version": 6.0.2900.2180

OK
Cancel

The following table gives an overview of the objects you can configure.

Table 189 Configuration > Object > Endpoint Security > Add

LABEL	DESCRIPTION
Show Advance Settings / Hide Advance Settings	Click this button to display a greater or lesser number of configuration fields.
General Settings	
Object Name	Specify a descriptive name for identification purposes. You can enter up to 31 characters ("0-9", "a-z", "A-Z", "-", "_ " with no spaces allowed).
Description	Enter a description of this object. It is not used elsewhere. You can use alphanumeric and () + / : = ? ! * # @ \$ _ % - characters, and it can be up to 60 characters long.
Endpoint Operating System	<p>Select the type of operating system the user's computer must be using. The checking items in the rest of the screen vary depending on the selected operating system. If you select Mac OSX, there are no other checking items.</p> <p>Others allows access for computers not using Windows, Linux, or Mac OSX operating systems. For example you create Windows, Linux, and Mac OSX endpoint security objects to apply to your LAN users. An "others" object allows access for LAN computers using Solaris, HP, Android, or other operating systems.</p>
Windows Version	If you selected Windows as the operating system, select the version of Windows here.
Endpoint must update to Windows Service Pack	If you selected Windows as the operating system, you can enter the minimum Windows service pack number the user's computer must have installed. The user's computer must have this service pack or higher. For example, "2" means service pack 2. Leave the field blank to have the ZyWALL ignore the Windows service pack number.
Passing Criterion	Select whether the user's computer has to match just one of the endpoint security object's checking criteria or all of them.
Checking Item - Windows Update	If you selected Windows as the operating system, you can select whether or not the user's computer must have the Windows Auto Update feature activated.
Checking Item - Security Patch	Use the table to list Windows security patches that the user's computer must have installed. The user's computer must have all of the listed Windows security patches installed to pass this checking item. Click Add to create a new entry. Select one or more entries and click Remove to delete it or them.
Checking Item - Personal Firewall	If you selected Windows as the operating system, you can select whether or not the user's computer is required to have personal firewall software installed. Move the permitted personal firewalls from the Available list to the Allowed Personal Firewall List . Use the [Shift] and/or [Ctrl] key to select multiple entries. The user's computer must have one of the listed personal firewalls to pass this checking item. For some personal firewalls the ZyWALL can also detect whether or not the firewall is activated; in those cases it must also be activated.

Table 189 Configuration > Object > Endpoint Security > Add (continued)

LABEL	DESCRIPTION
Checking Item - Anti-Virus Software	<p>If you selected Windows as the operating system, you can select whether or not the user's computer is required to have anti-virus software installed. Move the permitted anti-virus software packages from the Available list to the Allowed Anti-Virus Software List. Use the [Shift] and/or [Ctrl] key to select multiple entries. The user's computer must have one of the listed anti-virus software packages to pass this checking item. For some anti-virus software the ZyWALL can also detect whether or not the anti-virus software is activated; in those cases it must also be activated.</p>
Checking Item - Windows Registry	<p>If you selected Windows as the operating system, you can use the table to list Windows registry values to check on the user's computer.</p> <p>Use the Operation field to set whether the value for the registry item in the user's computer has to be equal to (=), greater than (>), less than (<), greater than or equal to (>=), less than or equal to (<=), or not equal to (!=) the value listed in the entry.</p> <p>Click Add to create a new entry. Select one or more entries and click Remove to delete it or them.</p> <p>The user's computer must pass all of the listed Windows registry value checks to pass this checking item.</p>
Checking Item - Required Processes	<p>If you selected Windows or Linux as the operating system, you can use this section to list applications that a user's computer must be running.</p> <p>Use the Processes Endpoints Must Have Running table to list processes that the user's computer must have running. The user's computer must have all of the listed applications running to pass this checking item.</p> <p>Include the filename extension for Linux operating systems.</p> <p>Click Add to create a new entry. Select one or more entries and click Remove to delete it or them.</p>
Checking Item - Forbidden Processes	<p>If you selected Windows or Linux as the operating system, you can use this section to list applications that a user's computer cannot be running.</p> <p>Use the Processes Endpoints Must NOT Have Running table to list processes that the user's computer are not permitted to have running. The user's computer must not have any of the listed applications running to pass this checking item.</p> <p>Include the filename extension for Linux operating systems.</p> <p>Click Add to create a new entry. Select one or more entries and click Remove to delete it or them.</p>

Table 189 Configuration > Object > Endpoint Security > Add (continued)

LABEL	DESCRIPTION
Checking Item - File Information	<p>If you selected Windows or Linux as the operating system, you can use this table to check details of specific files on the user's computer.</p> <p>Use the Operation field to set whether the size or version of the file on the user's computer has to be equal to (=), greater than (>), less than (<), greater than or equal to (>=), less than or equal to (<=), or not equal to (!=) the size or version of the file listed in the entry.</p> <p>Click Add to create a new entry. Select one or more entries and click Remove to delete it or them.</p> <p>The user's computer must pass one of the listed file information checks to pass this checking item.</p>
OK	Click OK to save your changes back to the ZyWALL.
Cancel	Click Cancel to exit this screen without saving.

43.1 Overview

Use the system screens to configure general ZyWALL settings.

43.1.1 What You Can Do in this Chapter

- Use the **System > Host Name** screen (see [Section 43.2 on page 630](#)) to configure a unique name for the ZyWALL in your network.
- Use the **System > USB Storage** screen (see [Section 43.2 on page 630](#)) to configure the settings for the connected USB devices.
- Use the **System > Date/Time** screen (see [Section 43.4 on page 631](#)) to configure the date and time for the ZyWALL.
- Use the **System > Console Speed** screen (see [Section 43.5 on page 636](#)) to configure the console port speed when you connect to the ZyWALL via the console port using a terminal emulation program.
- Use the **System > DNS** screen (see [Section 43.6 on page 636](#)) to configure the DNS (Domain Name System) server used for mapping a domain name to its corresponding IP address and vice versa.
- Use the **System > WWW** screens (see [Section 43.7 on page 644](#)) to configure settings for HTTP or HTTPS access to the ZyWALL and how the login and access user screens look.
- Use the **System > SSH** screen (see [Section 43.8 on page 661](#)) to configure SSH (Secure SHell) used to securely access the ZyWALL's command line interface. You can specify which zones allow SSH access and from which IP address the access can come.
- Use the **System > TELNET** screen (see [Section 43.9 on page 666](#)) to configure Telnet to access the ZyWALL's command line interface. Specify which zones allow Telnet access and from which IP address the access can come.
- Use the **System > FTP** screen (see [Section 43.10 on page 668](#)) to specify from which zones FTP can be used to access the ZyWALL. You can also specify from which IP addresses the access can come. You can upload and download the ZyWALL's firmware and configuration files using FTP. Please also see [Chapter 45 on page 693](#) for more information about firmware and configuration files.

- Your ZyWALL can act as an SNMP agent, which allows a manager station to manage and monitor the ZyWALL through the network. Use the **System > SNMP** screen (see [Section 43.11 on page 670](#)) to configure SNMP settings, including from which zones SNMP can be used to access the ZyWALL. You can also specify from which IP addresses the access can come.
- Vantage CNM (Centralized Network Management) is a browser-based global management tool that allows an administrator to manage ZyXEL devices. Use the **System > Vantage CNM** screen (see [Section 43.12 on page 674](#)) to allow your ZyWALL to be managed by the Vantage CNM server.
- Use the **System > Language** screen (see [Section 43.13 on page 677](#)) to set a language for the ZyWALL's Web Configurator screens.

Note: See each section for related background information and term definitions.

43.2 Host Name

A host name is the unique name by which a device is known on a network. Click **Configuration > System > Host Name** to open the **Host Name** screen.

Figure 367 Configuration > System > Host Name

The following table describes the labels in this screen.

Table 190 Configuration > System > Host Name

LABEL	DESCRIPTION
System Name	Choose a descriptive name to identify your ZyWALL device. This name can be up to 64 alphanumeric characters long. Spaces are not allowed, but dashes (-) underscores (_) and periods (.) are accepted.
Domain Name	Enter the domain name (if you know it) here. This name is propagated to DHCP clients connected to interfaces with the DHCP server enabled. This name can be up to 254 alphanumeric characters long. Spaces are not allowed, but dashes "-" are accepted.
Apply	Click Apply to save your changes back to the ZyWALL.
Reset	Click Reset to return the screen to its last-saved settings.

43.3 USB Storage

The ZyWALL can use a connected USB device to store the system log and other diagnostic information. Use this screen to turn on this feature and set a disk full warning limit.

Note: Only connect one USB device. It must allow writing (it cannot be read-only) and use the FAT16, FAT32, EXT2, or EXT3 file system. The ZyWALL uses the partition identified as “sda1”.

Click **Configuration > System > USB Storage** to open the screen as shown next.

Figure 368 Configuration > System > USB Storage

The following table describes the labels in this screen.

Table 191 Configuration > System > USB Storage

LABEL	DESCRIPTION
Activate USB storage service	Select this if you want to use the connected USB device(s).
Disk full warning when remaining space is less than	Set a number and select a unit (MB or %) to have the ZyWALL send a warning message when the remaining USB storage space is less than the value you set here.
Apply	Click Apply to save your changes back to the ZyWALL.
Reset	Click Reset to return the screen to its last-saved settings.

43.4 Date and Time

For effective scheduling and logging, the ZyWALL system time must be accurate. The ZyWALL’s Real Time Chip (RTC) keeps track of the time and date. There is also

a software mechanism to set the time manually or get the current time and date from an external server.

To change your ZyWALL's time based on your local time zone and date, click **Configuration > System > Date/Time**. The screen displays as shown. You can manually set the ZyWALL's time and date or have the ZyWALL get the date and time from a time server.

Figure 369 Configuration > System > Date and Time

The following table describes the labels in this screen.

Table 192 Configuration > System > Date and Time

LABEL	DESCRIPTION
Current Time and Date	
Current Time	This field displays the present time of your ZyWALL.
Current Date	This field displays the present date of your ZyWALL.
Time and Date Setup	
Manual	Select this radio button to enter the time and date manually. If you configure a new time and date, time zone and daylight saving at the same time, the time zone and daylight saving will affect the new time and date you entered. When you enter the time settings manually, the ZyWALL uses the new setting once you click Apply .

Table 192 Configuration > System > Date and Time (continued)

LABEL	DESCRIPTION
New Time (hh-mm-ss)	This field displays the last updated time from the time server or the last time configured manually. When you set Time and Date Setup to Manual , enter the new time in this field and then click Apply .
New Date (yyyy-mm-dd)	This field displays the last updated date from the time server or the last date configured manually. When you set Time and Date Setup to Manual , enter the new date in this field and then click Apply .
Get from Time Server	Select this radio button to have the ZyWALL get the time and date from the time server you specify below. The ZyWALL requests time and date settings from the time server under the following circumstances. <ul style="list-style-type: none"> • When the ZyWALL starts up. • When you click Apply or Synchronize Now in this screen. • 24-hour intervals after starting up.
Time Server Address	Enter the IP address or URL of your time server. Check with your ISP/network administrator if you are unsure of this information.
Sync. Now	Click this button to have the ZyWALL get the time and date from a time server (see the Time Server Address field). This also saves your changes (except the daylight saving settings).
Time Zone Setup	
Time Zone	Choose the time zone of your location. This will set the time difference between your time zone and Greenwich Mean Time (GMT).
Enable Daylight Saving	Daylight saving is a period from late spring to early fall when many countries set their clocks ahead of normal local time by one hour to give more daytime light in the evening. Select this option if you use Daylight Saving Time.
Start Date	Configure the day and time when Daylight Saving Time starts if you selected Enable Daylight Saving . The at field uses the 24 hour format. Here are a couple of examples: Daylight Saving Time starts in most parts of the United States on the second Sunday of March. Each time zone in the United States starts using Daylight Saving Time at 2 A.M. local time. So in the United States you would select Second, Sunday, March and type 2 in the at field. Daylight Saving Time starts in the European Union on the last Sunday of March. All of the time zones in the European Union start using Daylight Saving Time at the same moment (1 A.M. GMT or UTC). So in the European Union you would select Last, Sunday, March . The time you type in the at field depends on your time zone. In Germany for instance, you would type 2 because Germany's time zone is one hour ahead of GMT or UTC (GMT+1).

Table 192 Configuration > System > Date and Time (continued)

LABEL	DESCRIPTION
End Date	<p>Configure the day and time when Daylight Saving Time ends if you selected Enable Daylight Saving. The at field uses the 24 hour format. Here are a couple of examples:</p> <p>Daylight Saving Time ends in the United States on the first Sunday of November. Each time zone in the United States stops using Daylight Saving Time at 2 A.M. local time. So in the United States you would select First, Sunday, November and type 2 in the at field.</p> <p>Daylight Saving Time ends in the European Union on the last Sunday of October. All of the time zones in the European Union stop using Daylight Saving Time at the same moment (1 A.M. GMT or UTC). So in the European Union you would select Last, Sunday, October. The time you type in the at field depends on your time zone. In Germany for instance, you would type 2 because Germany's time zone is one hour ahead of GMT or UTC (GMT+1).</p>
Offset	<p>Specify how much the clock changes when daylight saving begins and ends.</p> <p>Enter a number from 1 to 5.5 (by 0.5 increments).</p> <p>For example, if you set this field to 3.5, a log occurred at 6 PM. in local official time will appear as if it had occurred at 10:30 P.M.</p>
Apply	Click Apply to save your changes back to the ZyWALL.
Reset	Click Reset to return the screen to its last-saved settings.

43.4.1 Pre-defined NTP Time Servers List

When you turn on the ZyWALL for the first time, the date and time start at 2003-01-01 00:00:00. The ZyWALL then attempts to synchronize with one of the following pre-defined list of Network Time Protocol (NTP) time servers.

The ZyWALL continues to use the following pre-defined list of NTP time servers if you do not specify a time server or it cannot synchronize with the time server you specified.

Table 193 Default Time Servers

0.pool.ntp.org
1.pool.ntp.org
2.pool.ntp.org

When the ZyWALL uses the pre-defined list of NTP time servers, it randomly selects one server and tries to synchronize with it. If the synchronization fails, then the ZyWALL goes through the rest of the list in order from the first one tried until either it is successful or all the pre-defined NTP time servers have been tried.

43.4.2 Time Server Synchronization

Click the **Synchronize Now** button to get the time and date from the time server you specified in the **Time Server Address** field.

When the **Please Wait...** screen appears, you may have to wait up to one minute.

Figure 370 Synchronization in Process



The **Current Time** and **Current Date** fields will display the appropriate settings if the synchronization is successful.

If the synchronization was not successful, a log displays in the **View Log** screen. Try re-configuring the **Date/Time** screen.

To manually set the ZyWALL date and time.

- 1 Click **System > Date/Time**.
- 2 Select **Manual** under **Time and Date Setup**.
- 3 Enter the ZyWALL's time in the **New Time** field.
- 4 Enter the ZyWALL's date in the **New Date** field.
- 5 Under **Time Zone Setup**, select your **Time Zone** from the list.
- 6 As an option you can select the **Enable Daylight Saving** check box to adjust the ZyWALL clock for daylight savings.
- 7 Click **Apply**.

To get the ZyWALL date and time from a time server

- 1 Click **System > Date/Time**.
- 2 Select **Get from Time Server** under **Time and Date Setup**.
- 3 Under **Time Zone Setup**, select your **Time Zone** from the list.
- 4 As an option you can select the **Enable Daylight Saving** check box to adjust the ZyWALL clock for daylight savings.

- 5 Under **Time and Date Setup**, enter a **Time Server Address** ([Table 193 on page 634](#)).
- 6 Click **Apply**.

43.5 Console Port Speed

This section shows you how to set the console port speed when you connect to the ZyWALL via the console port using a terminal emulation program. See [Table 2 on page 34](#) for default console port settings.

Click **Configuration > System > Console Speed** to open the **Console Speed** screen.

Figure 371 Configuration > System > Console Speed

The following table describes the labels in this screen.

Table 194 Configuration > System > Console Speed

LABEL	DESCRIPTION
Console Port Speed	Use the drop-down list box to change the speed of the console port. Your ZyWALL supports 9600, 19200, 38400, 57600, and 115200 bps (default) for the console port. The Console Port Speed applies to a console port connection using terminal emulation software and NOT the Console in the ZyWALL Web Configurator Status screen.
Apply	Click Apply to save your changes back to the ZyWALL.
Reset	Click Reset to return the screen to its last-saved settings.

43.6 DNS Overview

DNS (Domain Name System) is for mapping a domain name to its corresponding IP address and vice versa. The DNS server is extremely important because without it, you must know the IP address of a machine before you can access it.

43.6.1 DNS Server Address Assignment

The ZyWALL can get the DNS server addresses in the following ways.

- The ISP tells you the DNS server addresses, usually in the form of an information sheet, when you sign up. If your ISP gives you DNS server addresses, manually enter them in the DNS server fields.
- If your ISP dynamically assigns the DNS server IP addresses (along with the ZyWALL's WAN IP address), set the DNS server fields to get the DNS server address from the ISP.
- You can manually enter the IP addresses of other DNS servers.

43.6.2 Configuring the DNS Screen

Click **Configuration > System > DNS** to change your ZyWALL's DNS settings. Use the **DNS** screen to configure the ZyWALL to use a DNS server to resolve domain names for ZyWALL system features like VPN, DDNS and the time server. You can also configure the ZyWALL to accept or discard DNS queries. Use the **Network > Interface** screens to configure the DNS server information that the ZyWALL sends to the specified DHCP client devices.

Figure 372 Configuration > System > DNS

The screenshot shows the DNS configuration interface with the following sections:

- Address/PTR Record:** A table with columns '#', 'FQDN', and 'IP Address'. It is currently empty, showing 'No data to display'.
- Domain Zone Forwarder:** A table with columns '#', 'Domain Zone', 'Type', 'DNS Server', and 'Query via'. It contains one entry:

#	Domain Zone	Type	DNS Server	Query via
-	*	Default	10.5.5.1	wan2
- MX Record (for My FQDN):** A table with columns '#', 'Domain Name', and 'IP/FQDN'. It is currently empty, showing 'No data to display'.
- Service Control:** A table with columns '#', 'Zone', 'Address', and 'Action'. It contains one entry:

#	Zone	Address	Action
-	ALL	ALL	Accept

The following table describes the labels in this screen.

Table 195 Configuration > System > DNS

LABEL	DESCRIPTION
Address/PTR Record	This record specifies the mapping of a Fully-Qualified Domain Name (FQDN) to an IP address. An FQDN consists of a host and domain name. For example, www.zyxel.com.tw is a fully qualified domain name, where "www" is the host, "zyxel" is the third-level domain, "com" is the second-level domain, and "tw" is the top level domain.
Add	Click this to create a new entry.
Edit	Double-click an entry or select it and click Edit to be able to modify the entry's settings.
Remove	To remove an entry, select it and click Remove . The ZyWALL confirms you want to remove it before doing so. Note that subsequent entries move up by one when you take this action.
#	This is the index number of the address/PTR record.
FQDN	This is a host's fully qualified domain name.
IP Address	This is the IP address of a host.
Domain Zone Forwarder	This specifies a DNS server's IP address. The ZyWALL can query the DNS server to resolve domain zones for features like VPN, DDNS and the time server. When the ZyWALL needs to resolve a domain zone, it checks it against the domain zone forwarder entries in the order that they appear in this list.
Add	Click this to create a new entry. Select an entry and click Add to create a new entry after the selected entry.
Edit	Double-click an entry or select it and click Edit to be able to modify the entry's settings.
Remove	To remove an entry, select it and click Remove . The ZyWALL confirms you want to remove it before doing so. Note that subsequent entries move up by one when you take this action.
Move	To change an entry's position in the numbered list, select the method and click Move to display a field to type a number for where you want to put it and press [ENTER] to move the rule to the number that you typed.
#	This is the index number of the domain zone forwarder record. The ordering of your rules is important as rules are applied in sequence. A hyphen (-) displays for the default domain zone forwarder record. The default record is not configurable. The ZyWALL uses this default record if the domain zone that needs to be resolved does not match any of the other domain zone forwarder records.
Domain Zone	A domain zone is a fully qualified domain name without the host. For example, zyxel.com.tw is the domain zone for the www.zyxel.com.tw fully qualified domain name. A "*" means all domain zones.
Type	This displays whether the DNS server IP address is assigned by the ISP dynamically through a specified interface or configured manually (User-Defined).

Table 195 Configuration > System > DNS (continued)

LABEL	DESCRIPTION
DNS Server	This is the IP address of a DNS server. This field displays N/A if you have the ZyWALL get a DNS server IP address from the ISP dynamically but the specified interface is not active.
Query Via	This is the interface through which the ZyWALL sends DNS queries to the entry's DNS server. If the ZyWALL connects through a VPN tunnel, tunnel displays.
MX Record (for My FQDN)	A MX (Mail eXchange) record identifies a mail server that handles the mail for a particular domain.
Add	Click this to create a new entry.
Edit	Double-click an entry or select it and click Edit to be able to modify the entry's settings.
Remove	To remove an entry, select it and click Remove . The ZyWALL confirms you want to remove it before doing so. Note that subsequent entries move up by one when you take this action.
#	This is the index number of the MX record.
Domain Name	This is the domain name where the mail is destined for.
IP/FQDN	This is the IP address or Fully-Qualified Domain Name (FQDN) of a mail server that handles the mail for the domain specified in the field above.
Service Control	This specifies from which computers and zones you can send DNS queries to the ZyWALL.
Add	Click this to create a new entry. Select an entry and click Add to create a new entry after the selected entry.
Edit	Double-click an entry or select it and click Edit to be able to modify the entry's settings.
Remove	To remove an entry, select it and click Remove . The ZyWALL confirms you want to remove it before doing so. Note that subsequent entries move up by one when you take this action.
Move	To change an entry's position in the numbered list, select the method and click Move to display a field to type a number for where you want to put it and press [ENTER] to move the rule to the number that you typed.
#	This the index number of the service control rule. The ordering of your rules is important as rules are applied in sequence. The entry with a hyphen (-) instead of a number is the ZyWALL's (non-configurable) default policy. The ZyWALL applies this to traffic that does not match any other configured rule. It is not an editable rule. To apply other behavior, configure a rule that traffic will match so the ZyWALL will not have to use the default policy.
Zone	This is the zone on the ZyWALL the user is allowed or denied to access.
Address	This is the object name of the IP address(es) with which the computer is allowed or denied to send DNS queries.
Action	This displays whether the ZyWALL accepts DNS queries from the computer with the IP address specified above through the specified zone (Accept) or discards them (Deny).

43.6.3 Address Record

An address record contains the mapping of a Fully-Qualified Domain Name (FQDN) to an IP address. An FQDN consists of a host and domain name. For example, `www.zyxel.com` is a fully qualified domain name, where “www” is the host, “zyxel” is the second-level domain, and “com” is the top level domain. `mail.myZyXEL.com.tw` is also a FQDN, where “mail” is the host, “myZyXEL” is the third-level domain, “com” is the second-level domain, and “tw” is the top level domain.

The ZyWALL allows you to configure address records about the ZyWALL itself or another device. This way you can keep a record of DNS names and addresses that people on your network may use frequently. If the ZyWALL receives a DNS query for an FQDN for which the ZyWALL has an address record, the ZyWALL can send the IP address in a DNS response without having to query a DNS name server.

43.6.4 PTR Record

A PTR (pointer) record is also called a reverse record or a reverse lookup record. It is a mapping of an IP address to a domain name.

43.6.5 Adding an Address/PTR Record

Click the **Add** icon in the **Address/PTR Record** table to add an address/PTR record.

Figure 373 Configuration > System > DNS > Address/PTR Record Edit

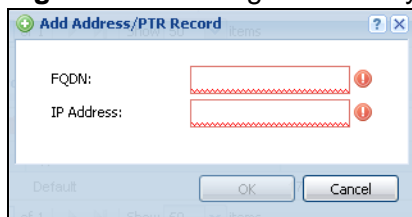

The following table describes the labels in this screen.

Table 196 Configuration > System > DNS > Address/PTR Record Edit

LABEL	DESCRIPTION
FQDN	Type a Fully-Qualified Domain Name (FQDN) of a server. An FQDN starts with a host name and continues all the way up to the top-level domain name. For example, www.zyxel.com.tw is a fully qualified domain name, where "www" is the host, "zyxel" is the third-level domain, "com" is the second-level domain, and "tw" is the top level domain. Underscores are not allowed. Use "*" as a prefix in the FQDN for a wildcard domain name (for example, *.example.com).
IP Address	Enter the IP address of the host in dotted decimal notation.
OK	Click OK to save your customized settings and exit this screen.
Cancel	Click Cancel to exit this screen without saving

43.6.6 Domain Zone Forwarder

A domain zone forwarder contains a DNS server's IP address. The ZyWALL can query the DNS server to resolve domain zones for features like VPN, DDNS and the time server. A domain zone is a fully qualified domain name without the host. For example, zyxel.com.tw is the domain zone for the www.zyxel.com.tw fully qualified domain name.

43.6.7 Adding a Domain Zone Forwarder

Click the **Add** icon in the **Domain Zone Forwarder** table to add a domain zone forwarder record.

Figure 374 Configuration > System > DNS > Domain Zone Forwarder Add

The following table describes the labels in this screen.

Table 197 Configuration > System > DNS > Domain Zone Forwarder Add

LABEL	DESCRIPTION
Domain Zone	<p>A domain zone is a fully qualified domain name without the host. For example, zyxel.com.tw is the domain zone for the www.zyxel.com.tw fully qualified domain name. For example, whenever the ZyWALL receives needs to resolve a zyxel.com.tw domain name, it can send a query to the recorded name server IP address.</p> <p>Enter * if all domain zones are served by the specified DNS server(s).</p>
DNS Server	<p>Select DNS Server(s) from ISP if your ISP dynamically assigns DNS server information. You also need to select an interface through which the ISP provides the DNS server IP address(es). The interface should be activated and set to be a DHCP client. The fields below display the (read-only) DNS server IP address(es) that the ISP assigns. N/A displays for any DNS server IP address fields for which the ISP does not assign an IP address.</p> <p>Select Public DNS Server if you have the IP address of a DNS server. Enter the DNS server's IP address in the field to the right. The ZyWALL must be able to connect to the DNS server without using a VPN tunnel. The DNS server could be on the Internet or one of the ZyWALL's local networks. You cannot use 0.0.0.0. Use the Query via field to select the interface through which the ZyWALL sends DNS queries to a DNS server.</p> <p>Select Private DNS Server if you have the IP address of a DNS server to which the ZyWALL connects through a VPN tunnel. Enter the DNS server's IP address in the field to the right. You cannot use 0.0.0.0.</p>
OK	Click OK to save your customized settings and exit this screen.
Cancel	Click Cancel to exit this screen without saving

43.6.8 MX Record

A MX (Mail eXchange) record indicates which host is responsible for the mail for a particular domain, that is, controls where mail is sent for that domain. If you do not configure proper MX records for your domain or other domain, external e-mail from other mail servers will not be able to be delivered to your mail server and vice versa. Each host or domain can have only one MX record, that is, one domain is mapping to one host.

43.6.9 Adding a MX Record

Click the **Add** icon in the **MX Record** table to add a MX record.

Figure 375 Configuration > System > DNS > MX Record Add

The following table describes the labels in this screen.

Table 198 Configuration > System > DNS > MX Record Add

LABEL	DESCRIPTION
Domain Name	Enter the domain name where the mail is destined for.
IP Address/ FQDN	Enter the IP address or Fully-Qualified Domain Name (FQDN) of a mail server that handles the mail for the domain specified in the field above.
OK	Click OK to save your customized settings and exit this screen.
Cancel	Click Cancel to exit this screen without saving

43.6.10 Adding a DNS Service Control Rule

Click the **Add** icon in the **Service Control** table to add a service control rule.

Figure 376 Configuration > System > DNS > Service Control Rule Add

The following table describes the labels in this screen.

Table 199 Configuration > System > DNS > Service Control Rule Add

LABEL	DESCRIPTION
Create new Object	Use this to configure any new settings objects that you need to use in this screen.
Address Object	Select ALL to allow or deny any computer to send DNS queries to the ZyWALL. Select a predefined address object to just allow or deny the computer with the IP address that you specified to send DNS queries to the ZyWALL.
Zone	Select ALL to allow or prevent DNS queries through any zones. Select a predefined zone on which a DNS query to the ZyWALL is allowed or denied.
Action	Select Accept to have the ZyWALL allow the DNS queries from the specified computer. Select Deny to have the ZyWALL reject the DNS queries from the specified computer.
OK	Click OK to save your customized settings and exit this screen.
Cancel	Click Cancel to exit this screen without saving

43.7 WWW Overview

The following figure shows secure and insecure management of the ZyWALL coming in from the WAN. HTTPS and SSH access are secure. HTTP and Telnet access are not secure.

- See [Section 6.7.1 on page 105](#) for related information on these screens.

Note: To allow the ZyWALL to be accessed from a specified computer using a service, make sure you do not have a service control rule or to-ZyWALL firewall rule to block that traffic.

- See [To-ZyWALL Rules on page 375](#) for more on To-ZyWALL firewall rules.
- See [Section 7.8 on page 129](#) for an example of configuring service control to block administrator HTTPS access from all zones except the LAN.

To stop a service from accessing the ZyWALL, clear **Enable** in the corresponding service screen.

43.7.1 Service Access Limitations

A service cannot be used to access the ZyWALL when:

- 1 You have disabled that service in the corresponding screen.
- 2 The allowed IP address (address object) in the **Service Control** table does not match the client IP address (the ZyWALL disallows the session).
- 3 The IP address (address object) in the **Service Control** table is not in the allowed zone or the action is set to **Deny**.
- 4 There is a firewall rule that blocks it.

43.7.2 System Timeout

There is a lease timeout for administrators. The ZyWALL automatically logs you out if the management session remains idle for longer than this timeout period. The management session does not time out when a statistics screen is polling.

Each user is also forced to log in the ZyWALL for authentication again when the reauthentication time expires.

You can change the timeout settings in the **User/Group** screens.

43.7.3 HTTPS

You can set the ZyWALL to use HTTP or HTTPS (HTTPS adds security) for Web Configurator sessions. Specify which zones allow Web Configurator access and from which IP address the access can come.

HTTPS (HyperText Transfer Protocol over Secure Socket Layer, or HTTP over SSL) is a web protocol that encrypts and decrypts web pages. Secure Socket Layer (SSL) is an application-level protocol that enables secure transactions of data by ensuring confidentiality (an unauthorized party cannot read the transferred data), authentication (one party can identify the other party) and data integrity (you know if data has been changed).

It relies upon certificates, public keys, and private keys (see [Chapter 39 on page 589](#) for more information).

HTTPS on the ZyWALL is used so that you can securely access the ZyWALL using the Web Configurator. The SSL protocol specifies that the HTTPS server (the ZyWALL) must always authenticate itself to the HTTPS client (the computer which requests the HTTPS connection with the ZyWALL), whereas the HTTPS client only should authenticate itself when the HTTPS server requires it to do so (select **Authenticate Client Certificates** in the **WWW** screen). **Authenticate Client Certificates** is optional and if selected means the HTTPS client must send the ZyWALL a certificate. You must apply for a certificate for the browser from a CA that is a trusted CA on the ZyWALL.

Please refer to the following figure.

- 1 HTTPS connection requests from an SSL-aware web browser go to port 443 (by default) on the ZyWALL's web server.
- 2 HTTP connection requests from a web browser go to port 80 (by default) on the ZyWALL's web server.

Figure 377 HTTP/HTTPS Implementation

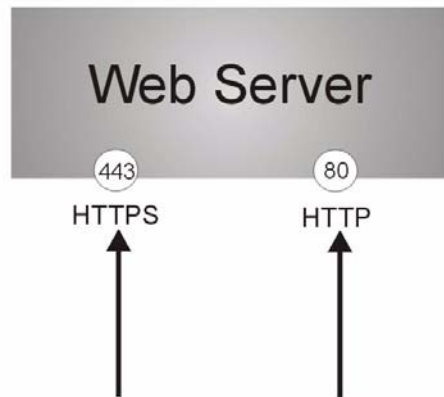

Note: If you disable **HTTP** in the **WWW** screen, then the ZyWALL blocks all HTTP connection attempts.

43.7.4 Configuring WWW Service Control

Click **Configuration > System > WWW** to open the **WWW** screen. Use this screen to specify from which zones you can access the ZyWALL using HTTP or HTTPS. You can also specify which IP addresses the access can come from.

Note: **Admin Service Control** deals with management access (to the Web Configurator).
User Service Control deals with user access to the ZyWALL (logging into SSL VPN for example).

Figure 378 Configuration > System > WWW > Service Control

The screenshot shows the 'Service Control' configuration page. It is organized into three main sections: HTTPS, HTTP, and Authentication. Each section contains an 'Enable' checkbox and a 'Server Port' input field. Below these are two tables: 'Admin Service Control' and 'User Service Control'. Each table has columns for '#', 'Zone', 'Address', and 'Action'. The 'ALL' zone is listed in both tables with an 'accept' action. At the bottom of the page are 'Apply' and 'Reset' buttons.

The following table describes the labels in this screen.

Table 200 Configuration > System > WWW > Service Control

LABEL	DESCRIPTION
HTTPS	
Enable	Select the check box to allow or disallow the computer with the IP address that matches the IP address(es) in the Service Control table to access the ZyWALL Web Configurator using secure HTTPS connections.

Table 200 Configuration > System > WWW > Service Control (continued)

LABEL	DESCRIPTION
Server Port	The HTTPS server listens on port 443 by default. If you change the HTTPS server port to a different number on the ZyWALL, for example 8443, then you must notify people who need to access the ZyWALL Web Configurator to use "https://ZyWALL IP Address: 8443 " as the URL.
Authenticate Client Certificates	Select Authenticate Client Certificates (optional) to require the SSL client to authenticate itself to the ZyWALL by sending the ZyWALL a certificate. To do that the SSL client must have a CA-signed certificate from a CA that has been imported as a trusted CA on the ZyWALL (see Section 43.7.7.5 on page 656 on importing certificates for details).
Server Certificate	Select a certificate the HTTPS server (the ZyWALL) uses to authenticate itself to the HTTPS client. You must have certificates already configured in the My Certificates screen.
Redirect HTTP to HTTPS	To allow only secure Web Configurator access, select this to redirect all HTTP connection requests to the HTTPS server.
Admin/User Service Control	Admin Service Control specifies from which zones an administrator can use HTTPS to manage the ZyWALL (using the Web Configurator). You can also specify the IP addresses from which the administrators can manage the ZyWALL. User Service Control specifies from which zones a user can use HTTPS to log into the ZyWALL (to log into SSL VPN for example). You can also specify the IP addresses from which the users can access the ZyWALL.
Add	Click this to create a new entry. Select an entry and click Add to create a new entry after the selected entry.
Edit	Double-click an entry or select it and click Edit to be able to modify the entry's settings.
Remove	To remove an entry, select it and click Remove . The ZyWALL confirms you want to remove it before doing so. Note that subsequent entries move up by one when you take this action.
Move	To change an entry's position in the numbered list, select the method and click Move to display a field to type a number for where you want to put it and press [ENTER] to move the rule to the number that you typed.
#	This is the index number of the service control rule. The entry with a hyphen (-) instead of a number is the ZyWALL's (non-configurable) default policy. The ZyWALL applies this to traffic that does not match any other configured rule. It is not an editable rule. To apply other behavior, configure a rule that traffic will match so the ZyWALL will not have to use the default policy.
Zone	This is the zone on the ZyWALL the user is allowed or denied to access.
Address	This is the object name of the IP address(es) with which the computer is allowed or denied to access.
Action	This displays whether the computer with the IP address specified above can access the ZyWALL zone(s) configured in the Zone field (Accept) or not (Deny).

Table 200 Configuration > System > WWW > Service Control (continued)

LABEL	DESCRIPTION
HTTP	
Enable	Select the check box to allow or disallow the computer with the IP address that matches the IP address(es) in the Service Control table to access the ZyWALL Web Configurator using HTTP connections.
Server Port	You may change the server port number for a service if needed, however you must use the same port number in order to use that service to access the ZyWALL.
Admin/User Service Control	<p>Admin Service Control specifies from which zones an administrator can use HTTP to manage the ZyWALL (using the Web Configurator). You can also specify the IP addresses from which the administrators can manage the ZyWALL.</p> <p>User Service Control specifies from which zones a user can use HTTP to log into the ZyWALL (to log into SSL VPN for example). You can also specify the IP addresses from which the users can access the ZyWALL.</p>
Add	Click this to create a new entry. Select an entry and click Add to create a new entry after the selected entry.
Edit	Double-click an entry or select it and click Edit to be able to modify the entry's settings.
Remove	To remove an entry, select it and click Remove . The ZyWALL confirms you want to remove it before doing so. Note that subsequent entries move up by one when you take this action.
Move	To change an entry's position in the numbered list, select the method and click Move to display a field to type a number for where you want to put it and press [ENTER] to move the rule to the number that you typed.
#	<p>This is the index number of the service control rule.</p> <p>The entry with a hyphen (-) instead of a number is the ZyWALL's (non-configurable) default policy. The ZyWALL applies this to traffic that does not match any other configured rule. It is not an editable rule. To apply other behavior, configure a rule that traffic will match so the ZyWALL will not have to use the default policy.</p>
Zone	This is the zone on the ZyWALL the user is allowed or denied to access.
Address	This is the object name of the IP address(es) with which the computer is allowed or denied to access.
Action	This displays whether the computer with the IP address specified above can access the ZyWALL zone(s) configured in the Zone field (Accept) or not (Deny).
Authentication	
Client Authentication Method	<p>Select a method the HTTPS or HTTP server uses to authenticate a client.</p> <p>You must have configured the authentication methods in the Auth. method screen.</p>

Table 200 Configuration > System > WWW > Service Control (continued)

LABEL	DESCRIPTION
Apply	Click Apply to save your changes back to the ZyWALL.
Reset	Click Reset to return the screen to its last-saved settings.

43.7.5 Service Control Rules

Click **Add** or **Edit** in the **Service Control** table in a **WWW, SSH, Telnet, FTP** or **SNMP** screen to add a service control rule.

Figure 379 Configuration > System > Service Control Rule > Edit

The following table describes the labels in this screen.

Table 201 Configuration > System > Service Control Rule > Edit

LABEL	DESCRIPTION
Create new Object	Use this to configure any new settings objects that you need to use in this screen.
Address Object	Select ALL to allow or deny any computer to communicate with the ZyWALL using this service. Select a predefined address object to just allow or deny the computer with the IP address that you specified to access the ZyWALL using this service.
Zone	Select ALL to allow or prevent any ZyWALL zones from being accessed using this service. Select a predefined ZyWALL zone on which a incoming service is allowed or denied.
Action	Select Accept to allow the user to access the ZyWALL from the specified computers. Select Deny to block the user's access to the ZyWALL from the specified computers.
OK	Click OK to save your customized settings and exit this screen.
Cancel	Click Cancel to exit this screen without saving

43.7.6 Customizing the WWW Login Page

Click **Configuration > System > WWW > Login Page** to open the **Login Page** screen. Use this screen to customize the Web Configurator login screen. You can

also customize the page that displays after an access user logs into the Web Configurator to access network services like the Internet. See [Chapter 33 on page 539](#) for more on access user accounts.

Figure 380 Configuration > System > WWW > Login Page

Service Control | **Login Page**

Select Type

Use Default Login Page

Use Customized Login Page

Logo File

To upload a logo file (*.gif/png/jpg), browse to the location of the file and then click Upload.

File Path: Select a file path

Customized Login Page

Title:

Title Color: (CSS color code)

Message Color: (CSS color code)

Note Message:

Background

Picture

Color (CSS color code)

Customized Access Page

Title:

Message Color: (CSS color code)

Note Message:

Window Background

Picture

Color (CSS color code)

My Device

Enter User Name/Password and click to login.

User Name:

Password:

One-Time Password: (Optional)
(max. 31 alphanumeric, printable characters and no spaces)

Error Message

Note:

1. Turn on Javascript and Cookie setting in your web browser.
2. Turn off Popup Window Blocking in your web browser.
3. Turn on Java Runtime Environment (JRE) in your web browser.

This is the note you can configure.

You now have logged in.

Click the logout button to terminate the access session.
undefined
For security reason you must login in again after

User-defined lease time (max

Remaining time before lease timeout (hh:mm:ss): 23:03:39

Remaining time before auth. timeout (hh:mm):

none

The following figures identify the parts you can customize in the login and access pages.

Figure 381 Login Page Customization

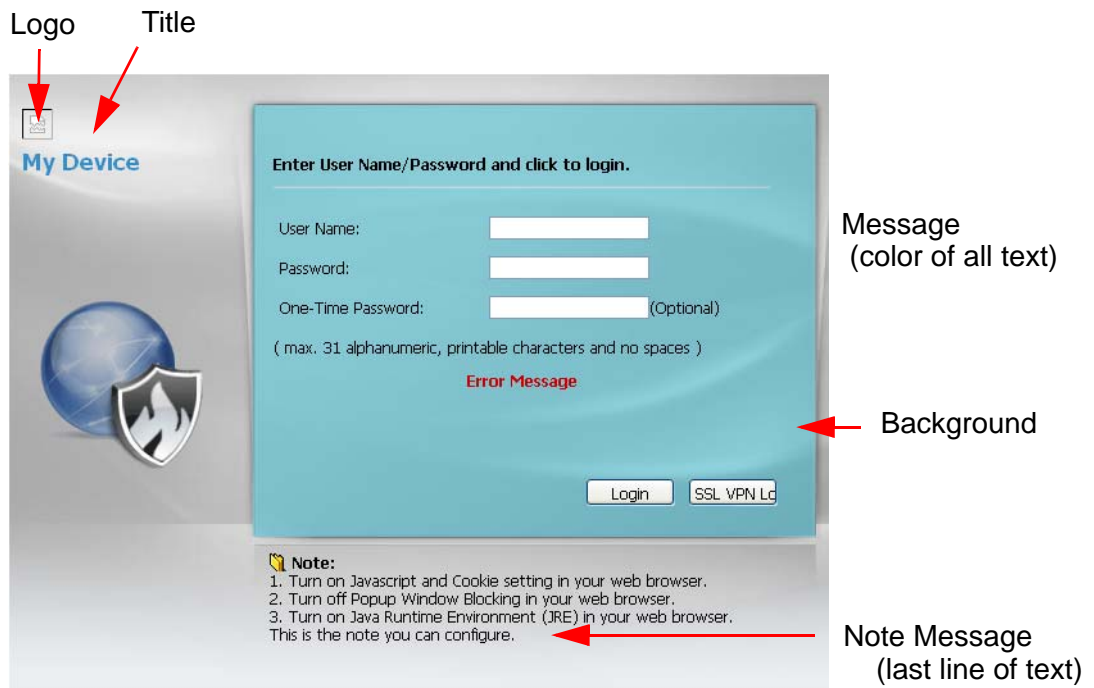
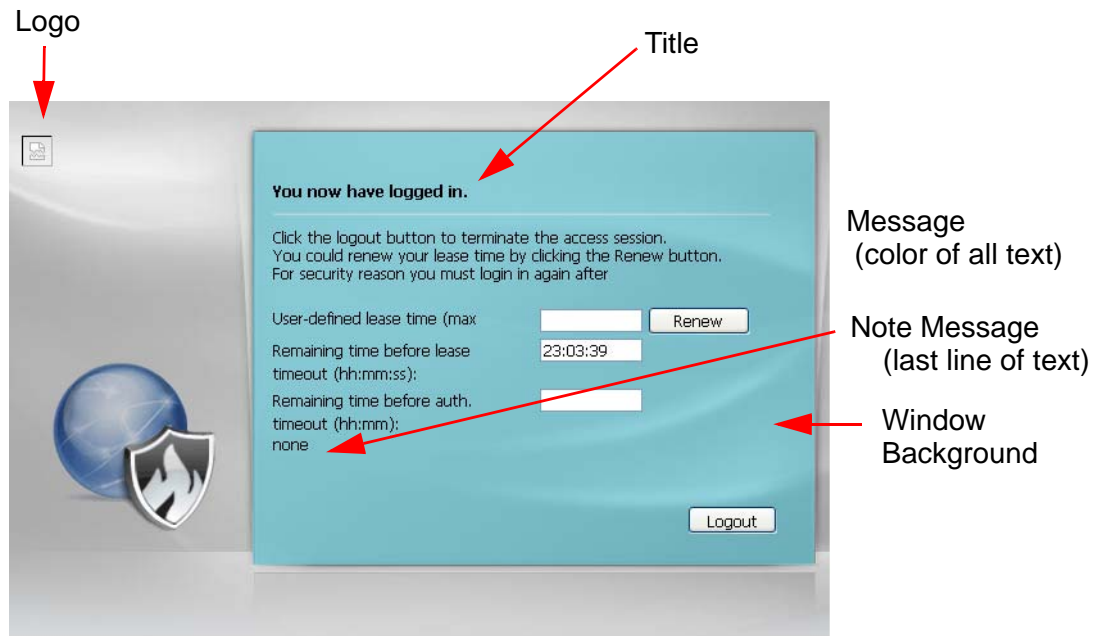

Figure 382 Access Page Customization



You can specify colors in one of the following ways:

- Click **Color** to display a screen of web-safe colors from which to choose.
- Enter the name of the desired color.
- Enter a pound sign (#) followed by the six-digit hexadecimal number that represents the desired color. For example, use "#000000" for black.
- Enter "rgb" followed by red, green, and blue values in parenthesis and separate by commas. For example, use "rgb(0,0,0)" for black.

Your desired color should display in the preview screen on the right after you click in another field, click **Apply**, or press [ENTER]. If your desired color does not display, your browser may not support it. Try selecting another color.

The following table describes the labels in the screen.

Table 202 Configuration > System > WWW > Login Page

LABEL	DESCRIPTION
Select Type	Select whether the Web Configurator uses the default login screen or one that you customize in the rest of this screen.
Logo File	You can upload a graphic logo to be displayed on the upper left corner of the Web Configurator login screen and access page. Specify the location and file name of the logo graphic or click Browse to locate it. Note: Use a GIF, JPG, or PNG of 100 kilobytes or less. Click Upload to transfer the specified graphic file from your computer to the ZyWALL.
Customized Login Page	Use this section to set how the Web Configurator login screen looks.
Title	Enter the title for the top of the screen. Use up to 64 printable ASCII characters. Spaces are allowed.
Title Color	Specify the color of the screen's title text.
Message Color	Specify the color of the screen's text.
Note Message	Enter a note to display at the bottom of the screen. Use up to 64 printable ASCII characters. Spaces are allowed.
Background	Set how the screen background looks. To use a graphic, select Picture and upload a graphic. Specify the location and file name of the logo graphic or click Browse to locate it. Note: Use a GIF, JPG, or PNG of 100 kilobytes or less. To use a color, select Color and specify the color.
Customized Access Page	Use this section to customize the page that displays after an access user logs into the Web Configurator to access network services like the Internet.
Title	Enter the title for the top of the screen. Use up to 64 printable ASCII characters. Spaces are allowed.
Message Color	Specify the color of the screen's text.

Table 202 Configuration > System > WWW > Login Page

LABEL	DESCRIPTION
Note Message	Enter a note to display below the title. Use up to 64 printable ASCII characters. Spaces are allowed.
Window Background	Set how the window's background looks. To use a graphic, select Picture and upload a graphic. Specify the location and file name of the logo graphic or click Browse to locate it. Note: Use a GIF, JPG, or PNG of 100 kilobytes or less. To use a color, select Color and specify the color.
Apply	Click Apply to save your changes back to the ZyWALL.
Reset	Click Reset to return the screen to its last-saved settings.

43.7.7 HTTPS Example

If you haven't changed the default HTTPS port on the ZyWALL, then in your browser enter "https://ZyWALL IP Address/" as the web site address where "ZyWALL IP Address" is the IP address or domain name of the ZyWALL you wish to access.

43.7.7.1 Internet Explorer Warning Messages

When you attempt to access the ZyWALL HTTPS server, a Windows dialog box pops up asking if you trust the server certificate. Click **View Certificate** if you want to verify that the certificate is from the ZyWALL.

You see the following **Security Alert** screen in Internet Explorer. Select **Yes** to proceed to the Web Configurator login screen; if you select **No**, then Web Configurator access is blocked.

Figure 383 Security Alert Dialog Box (Internet Explorer)

43.7.7.2 Netscape Navigator Warning Messages

When you attempt to access the ZyWALL HTTPS server, a **Website Certified by an Unknown Authority** screen pops up asking if you trust the server certificate. Click **Examine Certificate** if you want to verify that the certificate is from the ZyWALL.

If **Accept this certificate temporarily for this session** is selected, then click **OK** to continue in Netscape.

Select **Accept this certificate permanently** to import the ZyWALL's certificate into the SSL client.

Figure 384 Security Certificate 1 (Netscape)



Figure 385 Security Certificate 2 (Netscape)



43.7.7.3 Avoiding Browser Warning Messages

Here are the main reasons your browser displays warnings about the ZyWALL's HTTPS server certificate and what you can do to avoid seeing the warnings:

- The issuing certificate authority of the ZyWALL's HTTPS server certificate is not one of the browser's trusted certificate authorities. The issuing certificate authority of the ZyWALL's factory default certificate is the ZyWALL itself since the certificate is a self-signed certificate.
- For the browser to trust a self-signed certificate, import the self-signed certificate into your operating system as a trusted certificate.
- To have the browser trust the certificates issued by a certificate authority, import the certificate authority's certificate into your operating system as a trusted certificate. Refer to [Appendix D on page 819](#) for details.

43.7.7.4 Login Screen

After you accept the certificate, the ZyWALL login screen appears. The lock displayed in the bottom of the browser status bar denotes a secure connection.

Figure 386 Login Screen (Internet Explorer)

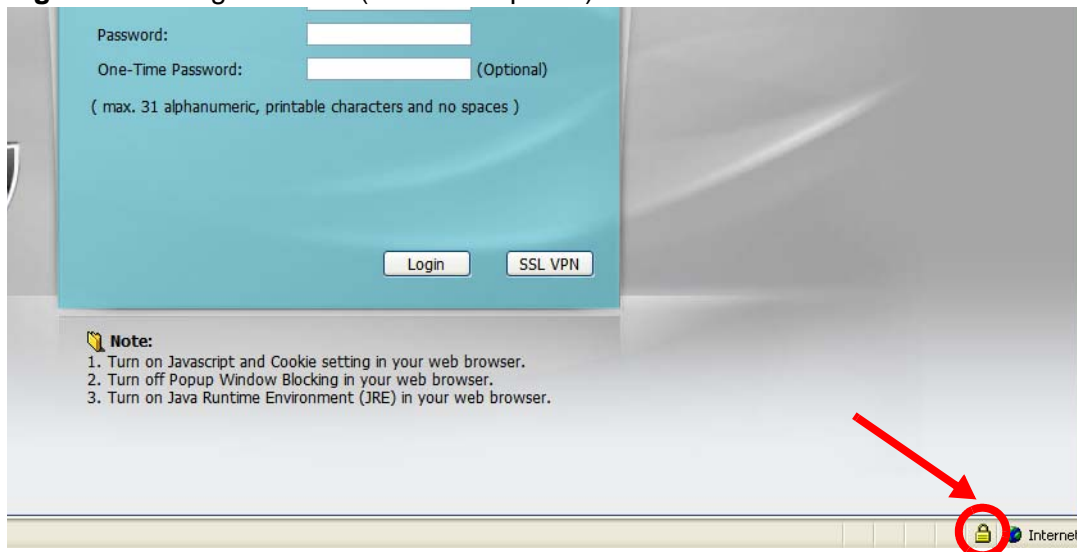

43.7.7.5 Enrolling and Importing SSL Client Certificates

The SSL client needs a certificate if **Authenticate Client Certificates** is selected on the ZyWALL.

You must have imported at least one trusted CA to the ZyWALL in order for the **Authenticate Client Certificates** to be active (see the Certificates chapter for details).

Apply for a certificate from a Certification Authority (CA) that is trusted by the ZyWALL (see the ZyWALL's **Trusted CA** Web Configurator screen).

Figure 387 ZyWALL Trusted CA Screen

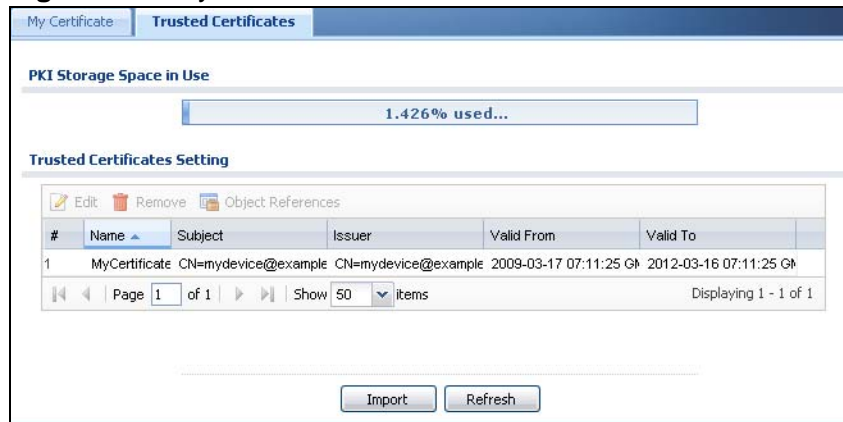

The CA sends you a package containing the CA's trusted certificate(s), your personal certificate(s) and a password to install the personal certificate(s).

43.7.7.5.1 Installing the CA's Certificate

- 1 Double click the CA's trusted certificate to produce a screen similar to the one shown next.

Figure 388 CA Certificate Example

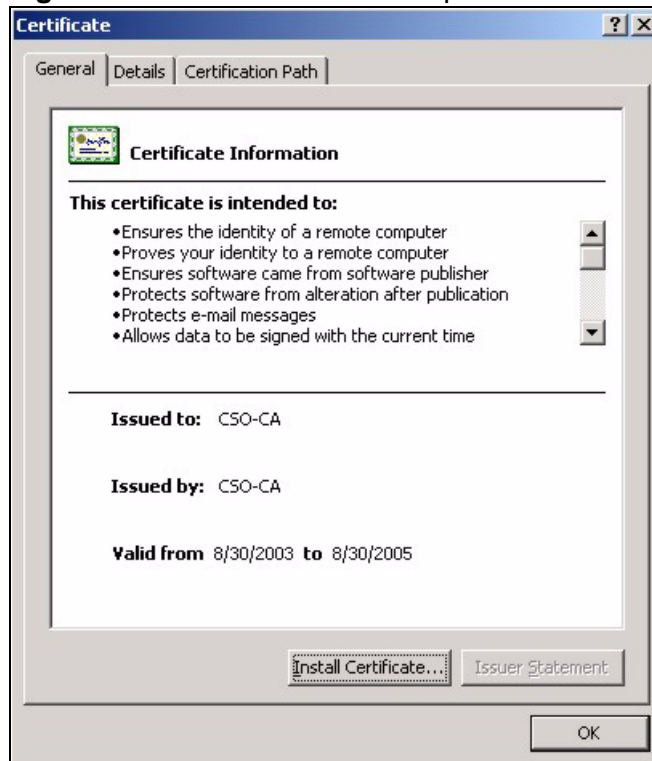

- 2 Click **Install Certificate** and follow the wizard as shown earlier in this appendix.

43.7.7.5.2 Installing Your Personal Certificate(s)

You need a password in advance. The CA may issue the password or you may have to specify it during the enrollment. Double-click the personal certificate given to you by the CA to produce a screen similar to the one shown next

- 1 Click **Next** to begin the wizard.

Figure 389 Personal Certificate Import Wizard 1



- 2 The file name and path of the certificate you double-clicked should automatically appear in the **File name** text box. Click **Browse** if you wish to import a different certificate.

Figure 390 Personal Certificate Import Wizard 2



- 3 Enter the password given to you by the CA.

Figure 391 Personal Certificate Import Wizard 3



The screenshot shows the 'Certificate Import Wizard' dialog box at the 'Password' step. The title bar reads 'Certificate Import Wizard'. The main text says 'To maintain security, the private key was protected with a password.' Below this, it prompts the user to 'Type the password for the private key.' There is a text input field labeled 'Password:'. Two checkboxes are present: 'Enable strong private key protection. You will be prompted every time the private key is used by an application if you enable this option.' and 'Mark the private key as exportable'. At the bottom, there are three buttons: '< Back', 'Next >', and 'Cancel'.

- 4 Have the wizard determine where the certificate should be saved on your computer or select **Place all certificates in the following store** and choose a different location.

Figure 392 Personal Certificate Import Wizard 4



The screenshot shows the 'Certificate Import Wizard' dialog box at the 'Certificate Store' step. The title bar reads 'Certificate Import Wizard'. The main text says 'Certificate stores are system areas where certificates are kept.' Below this, it prompts the user: 'Windows can automatically select a certificate store, or you can specify a location for'. There are two radio button options: 'Automatically select the certificate store based on the type of certificate' (which is selected) and 'Place all certificates in the following store'. Below the second option is a text input field labeled 'Certificate store:' with a 'Browse...' button to its right. At the bottom, there are three buttons: '< Back', 'Next >', and 'Cancel'.

- Click **Finish** to complete the wizard and begin the import process.

Figure 393 Personal Certificate Import Wizard 5



- You should see the following screen when the certificate is correctly installed on your computer.

Figure 394 Personal Certificate Import Wizard 6



43.7.7.6 Using a Certificate When Accessing the ZyWALL Example

Use the following procedure to access the ZyWALL via HTTPS.

- Enter 'https://ZyWALL IP Address/' in your browser's web address field.

Figure 395 Access the ZyWALL Via HTTPS



- When **Authenticate Client Certificates** is selected on the ZyWALL, the following screen asks you to select a personal certificate to send to the ZyWALL. This screen displays even if you only have a single certificate as in the example.

Figure 396 SSL Client Authentication

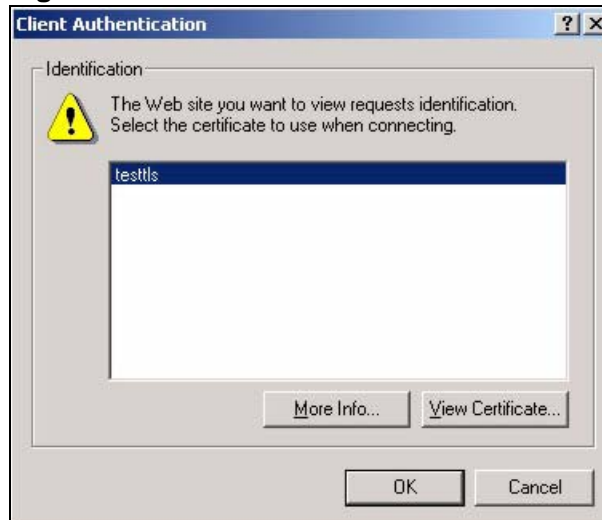

- You next see the Web Configurator login screen.

Figure 397 Secure Web Configurator Login Screen

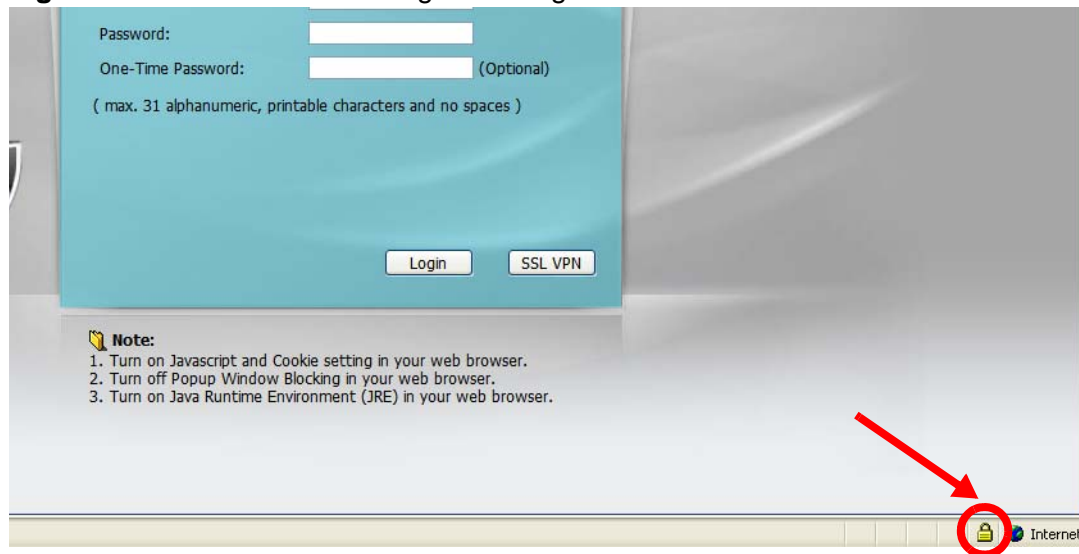

43.8 SSH

You can use SSH (Secure SHell) to securely access the ZyWALL's command line interface. Specify which zones allow SSH access and from which IP address the access can come.

SSH is a secure communication protocol that combines authentication and data encryption to provide secure encrypted communication between two hosts over an unsecured network. In the following figure, computer A on the Internet uses SSH to securely connect to the WAN port of the ZyWALL for a management session.

Figure 398 SSH Communication Over the WAN Example



43.8.1 How SSH Works

The following figure is an example of how a secure connection is established between two remote hosts using SSH v1.

Figure 399 How SSH v1 Works Example

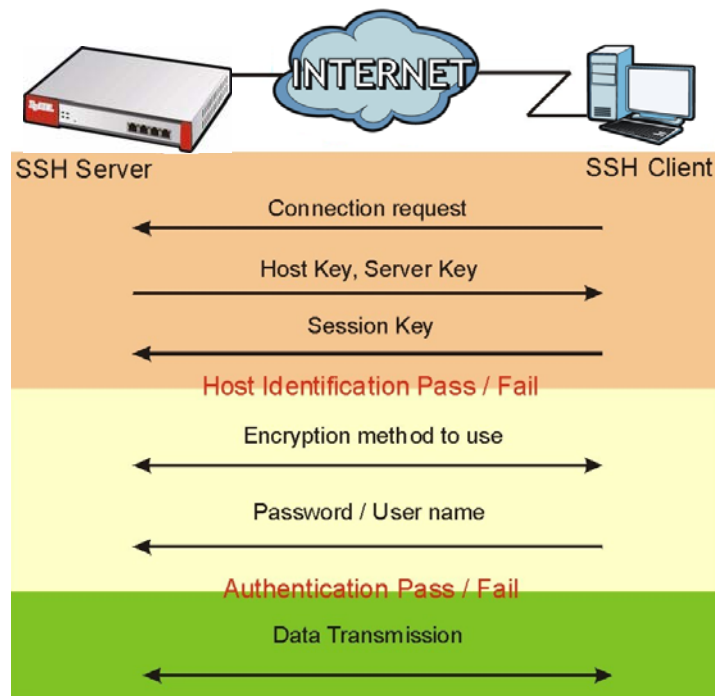

1 Host Identification

The SSH client sends a connection request to the SSH server. The server identifies itself with a host key. The client encrypts a randomly generated session key with the host key and server key and sends the result back to the server.

The client automatically saves any new server public keys. In subsequent connections, the server public key is checked against the saved version on the client computer.

2 Encryption Method

Once the identification is verified, both the client and server must agree on the type of encryption method to use.

3 Authentication and Data Transmission

After the identification is verified and data encryption activated, a secure tunnel is established between the client and the server. The client then sends its authentication information (user name and password) to the server to log in to the server.

43.8.2 SSH Implementation on the ZyWALL

Your ZyWALL supports SSH versions 1 and 2 using RSA authentication and four encryption methods (AES, 3DES, Archfour, and Blowfish). The SSH server is implemented on the ZyWALL for management using port 22 (by default).

43.8.3 Requirements for Using SSH

You must install an SSH client program on a client computer (Windows or Linux operating system) that is used to connect to the ZyWALL over SSH.

43.8.4 Configuring SSH

Click **Configuration > System > SSH** to change your ZyWALL's Secure Shell settings. Use this screen to specify from which zones SSH can be used to manage the ZyWALL. You can also specify from which IP addresses the access can come.

Note: It is recommended that you disable Telnet and FTP when you configure SSH for secure connections.

Figure 400 Configuration > System > SSH

The following table describes the labels in this screen.

Table 203 Configuration > System > SSH

LABEL	DESCRIPTION
Enable	Select the check box to allow or disallow the computer with the IP address that matches the IP address(es) in the Service Control table to access the ZyWALL CLI using this service.
Version 1	Select the check box to have the ZyWALL use both SSH version 1 and version 2 protocols. If you clear the check box, the ZyWALL uses only SSH version 2 protocol.
Server Port	You may change the server port number for a service if needed, however you must use the same port number in order to use that service for remote management.
Server Certificate	Select the certificate whose corresponding private key is to be used to identify the ZyWALL for SSH connections. You must have certificates already configured in the My Certificates screen (Click My Certificates and see Chapter 39 on page 589 for details).
Service Control	This specifies from which computers you can access which ZyWALL zones.
Add	Click this to create a new entry. Select an entry and click Add to create a new entry after the selected entry. Refer to Table 201 on page 650 for details on the screen that opens.
Edit	Double-click an entry or select it and click Edit to be able to modify the entry's settings.
Remove	To remove an entry, select it and click Remove . The ZyWALL confirms you want to remove it before doing so. Note that subsequent entries move up by one when you take this action.

Table 203 Configuration > System > SSH (continued)

LABEL	DESCRIPTION
Move	To change an entry's position in the numbered list, select the method and click Move to display a field to type a number for where you want to put it and press [ENTER] to move the rule to the number that you typed.
#	This the index number of the service control rule.
Zone	This is the zone on the ZyWALL the user is allowed or denied to access.
Address	This is the object name of the IP address(es) with which the computer is allowed or denied to access.
Action	This displays whether the computer with the IP address specified above can access the ZyWALL zone(s) configured in the Zone field (Accept) or not (Deny).
Apply	Click Apply to save your changes back to the ZyWALL.
Reset	Click Reset to return the screen to its last-saved settings.

43.8.5 Secure Telnet Using SSH Examples

This section shows two examples using a command interface and a graphical interface SSH client program to remotely access the ZyWALL. The configuration and connection steps are similar for most SSH client programs. Refer to your SSH client program user's guide.

43.8.5.1 Example 1: Microsoft Windows

This section describes how to access the ZyWALL using the Secure Shell Client program.

- 1 Launch the SSH client and specify the connection information (IP address, port number) for the ZyWALL.
- 2 Configure the SSH client to accept connection using SSH version 1.
- 3 A window displays prompting you to store the host key in you computer. Click **Yes** to continue.

Figure 401 SSH Example 1: Store Host Key

Enter the password to log in to the ZyWALL. The CLI screen displays next.

43.8.5.2 Example 2: Linux

This section describes how to access the ZyWALL using the OpenSSH client program that comes with most Linux distributions.

- 1 Test whether the SSH service is available on the ZyWALL.

Enter `telnet 192.168.1.1 22` at a terminal prompt and press [ENTER]. The computer attempts to connect to port 22 on the ZyWALL (using the default IP address of 192.168.1.1).

A message displays indicating the SSH protocol version supported by the ZyWALL.

Figure 402 SSH Example 2: Test

```
$ telnet 192.168.1.1 22
Trying 192.168.1.1...
Connected to 192.168.1.1.
Escape character is '^]'.
SSH-1.5-1.0.0
```

- 2 Enter `ssh -1 192.168.1.1`. This command forces your computer to connect to the ZyWALL using SSH version 1. If this is the first time you are connecting to the ZyWALL using SSH, a message displays prompting you to save the host information of the ZyWALL. Type `yes` and press [ENTER].

Then enter the password to log in to the ZyWALL.

Figure 403 SSH Example 2: Log in

```
$ ssh -1 192.168.1.1
The authenticity of host '192.168.1.1 (192.168.1.1)' can't be established.
RSA1 key fingerprint is 21:6c:07:25:7e:f4:75:80:ec:af:bd:d4:3d:80:53:d1.
Are you sure you want to continue connecting (yes/no)? yes
Warning: Permanently added '192.168.1.1' (RSA1) to the list of known hosts.
Administrator@192.168.1.1's password:
```

- 3 The CLI screen displays next.

43.9 Telnet

You can use Telnet to access the ZyWALL's command line interface. Specify which zones allow Telnet access and from which IP address the access can come.

43.9.1 Configuring Telnet

Click **Configuration > System > TELNET** to configure your ZyWALL for remote Telnet access. Use this screen to specify from which zones Telnet can be used to manage the ZyWALL. You can also specify from which IP addresses the access can come.

Figure 404 Configuration > System > TELNET

The following table describes the labels in this screen.

Table 204 Configuration > System > TELNET

LABEL	DESCRIPTION
Enable	Select the check box to allow or disallow the computer with the IP address that matches the IP address(es) in the Service Control table to access the ZyWALL CLI using this service.
Server Port	You may change the server port number for a service if needed, however you must use the same port number in order to use that service for remote management.
Service Control	This specifies from which computers you can access which ZyWALL zones.
Add	Click this to create a new entry. Select an entry and click Add to create a new entry after the selected entry. Refer to Table 201 on page 650 for details on the screen that opens.
Edit	Double-click an entry or select it and click Edit to be able to modify the entry's settings.
Remove	To remove an entry, select it and click Remove . The ZyWALL confirms you want to remove it before doing so. Note that subsequent entries move up by one when you take this action.
Move	To change an entry's position in the numbered list, select the method and click Move to display a field to type a number for where you want to put it and press [ENTER] to move the rule to the number that you typed.

Table 204 Configuration > System > TELNET (continued)

LABEL	DESCRIPTION
#	This the index number of the service control rule. The entry with a hyphen (-) instead of a number is the ZyWALL's (non-configurable) default policy. The ZyWALL applies this to traffic that does not match any other configured rule. It is not an editable rule. To apply other behavior, configure a rule that traffic will match so the ZyWALL will not have to use the default policy.
Zone	This is the zone on the ZyWALL the user is allowed or denied to access.
Address	This is the object name of the IP address(es) with which the computer is allowed or denied to access.
Action	This displays whether the computer with the IP address specified above can access the ZyWALL zone(s) configured in the Zone field (Accept) or not (Deny).
Apply	Click Apply to save your changes back to the ZyWALL.
Reset	Click Reset to return the screen to its last-saved settings.

43.10 FTP

You can upload and download the ZyWALL's firmware and configuration files using FTP. To use this feature, your computer must have an FTP client. Please see [Chapter 45 on page 693](#) for more information about firmware and configuration files.

43.10.1 Configuring FTP

To change your ZyWALL's FTP settings, click **Configuration > System > FTP** tab. The screen appears as shown. Use this screen to specify from which zones FTP can

be used to access the ZyWALL. You can also specify from which IP addresses the access can come.

Figure 405 Configuration > System > FTP

The screenshot shows the FTP configuration page. Under 'General Settings', the 'Enable' checkbox is checked, 'Server Port' is set to 21, and 'Server Certificate' is set to 'default'. The 'Service Control' section contains a table with one entry: Zone: ALL, Address: ALL, Action: Accept. The table has columns for #, Zone, Address, and Action. Below the table are navigation controls for page 1 of 1 and a 'Show 50 items' dropdown. At the bottom are 'Apply' and 'Reset' buttons.

The following table describes the labels in this screen.

Table 205 Configuration > System > FTP

LABEL	DESCRIPTION
Enable	Select the check box to allow or disallow the computer with the IP address that matches the IP address(es) in the Service Control table to access the ZyWALL using this service.
TLS required	Select the check box to use FTP over TLS (Transport Layer Security) to encrypt communication. This implements TLS as a security mechanism to secure FTP clients and/or servers.
Server Port	You may change the server port number for a service if needed, however you must use the same port number in order to use that service for remote management.
Server Certificate	Select the certificate whose corresponding private key is to be used to identify the ZyWALL for FTP connections. You must have certificates already configured in the My Certificates screen (Click My Certificates and see Chapter 39 on page 589 for details).
Service Control	This specifies from which computers you can access which ZyWALL zones.
Add	Click this to create a new entry. Select an entry and click Add to create a new entry after the selected entry. Refer to Table 201 on page 650 for details on the screen that opens.
Edit	Double-click an entry or select it and click Edit to be able to modify the entry's settings.
Remove	To remove an entry, select it and click Remove . The ZyWALL confirms you want to remove it before doing so. Note that subsequent entries move up by one when you take this action.

Table 205 Configuration > System > FTP (continued)

LABEL	DESCRIPTION
Move	To change an entry's position in the numbered list, select the method and click Move to display a field to type a number for where you want to put it and press [ENTER] to move the rule to the number that you typed.
#	This the index number of the service control rule. The entry with a hyphen (-) instead of a number is the ZyWALL's (non-configurable) default policy. The ZyWALL applies this to traffic that does not match any other configured rule. It is not an editable rule. To apply other behavior, configure a rule that traffic will match so the ZyWALL will not have to use the default policy.
Zone	This is the zone on the ZyWALL the user is allowed or denied to access.
Address	This is the object name of the IP address(es) with which the computer is allowed or denied to access.
Action	This displays whether the computer with the IP address specified above can access the ZyWALL zone(s) configured in the Zone field (Accept) or not (Deny).
Apply	Click Apply to save your changes back to the ZyWALL.
Reset	Click Reset to return the screen to its last-saved settings.

43.11 SNMP

Simple Network Management Protocol is a protocol used for exchanging management information between network devices. Your ZyWALL supports SNMP agent functionality, which allows a manager station to manage and monitor the ZyWALL through the network. The ZyWALL supports SNMP version one (SNMPv1)

and version two (SNMPv2c). The next figure illustrates an SNMP management operation.

Figure 406 SNMP Management Model

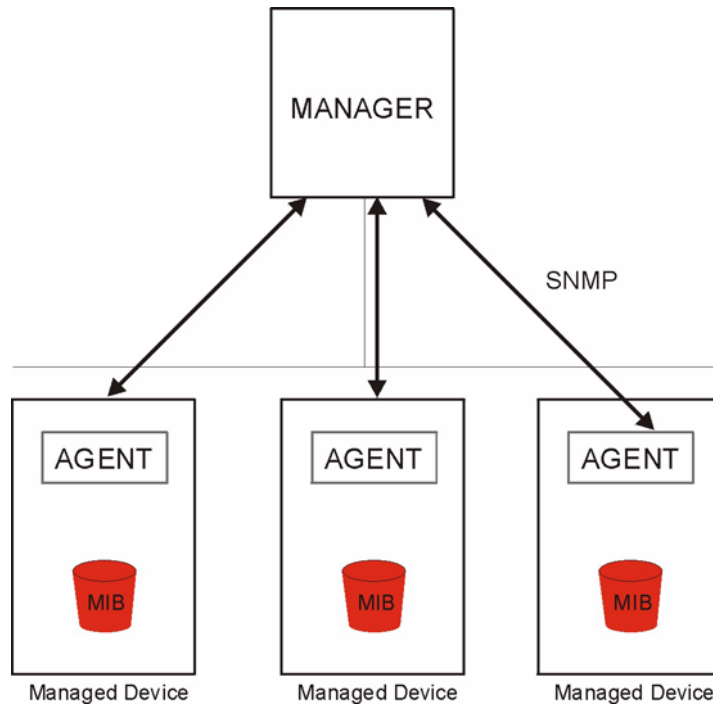

An SNMP managed network consists of two main types of component: agents and a manager.

An agent is a management software module that resides in a managed device (the ZyWALL). An agent translates the local management information from the managed device into a form compatible with SNMP. The manager is the console through which network administrators perform network management functions. It executes applications that control and monitor managed devices.

The managed devices contain object variables/managed objects that define each piece of information to be collected about a device. Examples of variables include such as number of packets received, node port status etc. A Management Information Base (MIB) is a collection of managed objects. SNMP allows a manager and agents to communicate for the purpose of accessing these objects.

SNMP itself is a simple request/response protocol based on the manager/agent model. The manager issues a request and the agent returns responses using the following protocol operations:

- Get - Allows the manager to retrieve an object variable from the agent.

- GetNext - Allows the manager to retrieve the next object variable from a table or list within an agent. In SNMPv1, when a manager wants to retrieve all elements of a table from an agent, it initiates a Get operation, followed by a series of GetNext operations.
- Set - Allows the manager to set values for object variables within an agent.
- Trap - Used by the agent to inform the manager of some events.

43.11.1 Supported MIBs

The ZyWALL supports MIB II that is defined in RFC-1213 and RFC-1215. The ZyWALL also supports private MIBs (zywall.mib and zyxel-zywall-ZLD-Common.mib) to collect information about CPU and memory usage and VPN total throughput. The focus of the MIBs is to let administrators collect statistical data and monitor status and performance. You can download the ZyWALL's MIBs from www.zyxel.com.

43.11.2 SNMP Traps

The ZyWALL will send traps to the SNMP manager when any one of the following events occurs.

Table 206 SNMP Traps

OBJECT LABEL	OBJECT ID	DESCRIPTION
Cold Start	1.3.6.1.6.3.1.1.5.1	This trap is sent when the ZyWALL is turned on or an agent restarts.
linkDown	1.3.6.1.6.3.1.1.5.3	This trap is sent when the Ethernet link is down.
linkUp	1.3.6.1.6.3.1.1.5.4	This trap is sent when the Ethernet link is up.
authenticationFailure	1.3.6.1.6.3.1.1.5.5	This trap is sent when an SNMP request comes from non-authenticated hosts.

43.11.3 Configuring SNMP

To change your ZyWALL's SNMP settings, click **Configuration > System > SNMP** tab. The screen appears as shown. Use this screen to configure your SNMP

settings, including from which zones SNMP can be used to access the ZyWALL. You can also specify from which IP addresses the access can come.

Figure 407 Configuration > System > SNMP

The screenshot shows the SNMP configuration page. Under 'General Settings', the 'Enable' checkbox is checked. The 'Server Port' is set to 161, 'Get Community' to public, and 'Set Community' to private. There are optional fields for 'Trap: Community' and 'Destination'. The 'Service Control' section contains a table with one row: Zone: ALL, Address: ALL, Action: Accept. The table has columns for #, Zone, Address, and Action. Below the table are 'Apply' and 'Reset' buttons.

The following table describes the labels in this screen.

Table 207 Configuration > System > SNMP

LABEL	DESCRIPTION
Enable	Select the check box to allow or disallow the computer with the IP address that matches the IP address(es) in the Service Control table to access the ZyWALL using this service.
Server Port	You may change the server port number for a service if needed, however you must use the same port number in order to use that service for remote management.
Get Community	Enter the Get Community , which is the password for the incoming Get and GetNext requests from the management station. The default is public and allows all requests.
Set Community	Enter the Set community , which is the password for incoming Set requests from the management station. The default is private and allows all requests.
Trap	
Community	Type the trap community, which is the password sent with each trap to the SNMP manager. The default is public and allows all requests.
Destination	Type the IP address of the station to send your SNMP traps to.
Service Control	This specifies from which computers you can access which ZyWALL zones.

Table 207 Configuration > System > SNMP (continued)

LABEL	DESCRIPTION
Add	Click this to create a new entry. Select an entry and click Add to create a new entry after the selected entry. Refer to Table 201 on page 650 for details on the screen that opens.
Edit	Double-click an entry or select it and click Edit to be able to modify the entry's settings.
Remove	To remove an entry, select it and click Remove . The ZyWALL confirms you want to remove it before doing so. Note that subsequent entries move up by one when you take this action.
Move	To change an entry's position in the numbered list, select the method and click Move to display a field to type a number for where you want to put it and press [ENTER] to move the rule to the number that you typed.
#	This is the index number of the service control rule. The entry with a hyphen (-) instead of a number is the ZyWALL's (non-configurable) default policy. The ZyWALL applies this to traffic that does not match any other configured rule. It is not an editable rule. To apply other behavior, configure a rule that traffic will match so the ZyWALL will not have to use the default policy.
Zone	This is the zone on the ZyWALL the user is allowed or denied to access.
Address	This is the object name of the IP address(es) with which the computer is allowed or denied to access.
Action	This displays whether the computer with the IP address specified above can access the ZyWALL zone(s) configured in the Zone field (Accept) or not (Deny).
Apply	Click Apply to save your changes back to the ZyWALL.
Reset	Click Reset to return the screen to its last-saved settings.

43.12 Vantage CNM

Vantage CNM (Centralized Network Management) is a browser-based global management solution that allows an administrator from any location to easily configure, manage, monitor and troubleshoot ZyXEL devices located worldwide. See the Vantage CNM User's Guide for details.

If you allow your ZyWALL to be managed by the Vantage CNM server, then you should not do any configurations directly to the ZyWALL (using either the Web Configurator or commands) without notifying the Vantage CNM administrator.

43.12.1 Configuring Vantage CNM

Vantage CNM is disabled on the device by default. Click **Configuration > System > Vantage CNM** to configure your device's Vantage CNM settings.

Figure 408 Configuration > System > Vantage CNM

The following table describes the labels in this screen.

Table 208 Configuration > System > Vantage CNM

LABEL	DESCRIPTION
Show Advance Settings / Hide Advance Settings	Click this button to display a greater or lesser number of configuration fields.
Vantage CNM	Click Advanced to display more configuration fields or click Basic to display fewer fields.
Enable	Select this check box to allow Vantage CNM to manage your ZyWALL.
Server IP Address/FQDN	<p>Enter the IP address or fully qualified domain name of the Vantage server.</p> <p>If the Vantage CNM server is on a different subnet to the ZyWALL and is behind a NAT router, enter the WAN IP address of the NAT router here and configure the NAT router to forward UDP port 11864 traffic to the Vantage CNM server.</p> <p>If the Vantage CNM server is behind a firewall, you may have to create a rule on the firewall to allow UDP port 11864 traffic through to the Vantage CNM server (most (new) ZyXEL firewalls automatically allow this).</p>

Table 208 Configuration > System > Vantage CNM (continued)

LABEL	DESCRIPTION
Transfer Protocol	<p>Select whether the Vantage CNM sessions should use regular HTTP connections or secure HTTPS connections.</p> <p>Note: HTTPS is recommended.</p> <p>The Vantage CNM server must use the same setting.</p>
Device Management IP	<p>Select Auto to have the ZyWALL allow Vantage CNM sessions to connect to any of the ZyWALL's IP addresses.</p> <p>Select Custom to specify the ZyWALL's IP address that allows Vantage CNM sessions. Configure the Custom IP field if you select this. You might for example need to specify the IP address when using a WAN trunk that uses multiple WAN IP addresses.</p>
Custom IP	Specify the ZyWALL's IP address that allows Vantage CNM sessions. This field applies when you select Custom in the Device Management IP field.
Keepalive Interval	Set how often the ZyWALL sends a keep alive packet to the Vantage CNM server if there is no other traffic. The keep alive packets maintain the Vantage CNM server's control session.
Periodic Inform Interval	Select this option to have the ZyWALL periodically send "Inform" messages to the Vantage CNM server.
HTTPS Authentication	When you are using HTTPSs, select this option to have the ZyWALL authenticate the Vantage CNM server's certificate. In order to do this you need to import the Vantage CNM server's public key (certificate) into the ZyWALL's trusted certificates.
Vantage Certificate	Select the Vantage CNM server's certificate. This applies when you enable HTTPS authentication.
Apply	Click Apply to save your changes back to the ZyWALL.
Reset	Click Reset to return the screen to its last-saved settings.

43.13 Language Screen

Click **Configuration > System > Language** to open the following screen. Use this screen to select a display language for the ZyWALL's Web Configurator screens.

Figure 409 Configuration > System > Language

The following table describes the labels in this screen.

Table 209 Configuration > System > Language

LABEL	DESCRIPTION
Language Setting	Select a display language for the ZyWALL's Web Configurator screens. You also need to open a new browser session to display the screens in the new language.
Apply	Click Apply to save your changes back to the ZyWALL.
Reset	Click Reset to return the screen to its last-saved settings.

Log and Report

44.1 Overview

Use these screens to configure daily reporting and log settings.

44.1.1 What You Can Do In this Chapter

- Use the **Email Daily Report** screen ([Section 44.2 on page 679](#)) to configure where and how to send daily reports and what reports to send.
- Use the **Maintenance > Log Setting** screens ([Section 44.3 on page 681](#)) to specify which log messages are e-mailed, where they are e-mailed, and how often they are e-mailed.

44.2 Email Daily Report

Use the **Email Daily Report** screen to start or stop data collection and view various statistics about traffic passing through your ZyWALL.

Note: Data collection may decrease the ZyWALL's traffic throughput rate.

Click **Configuration > Log & Report > Email Daily Report** to display the following screen. Configure this screen to have the ZyWALL e-mail you system statistics every day.

Figure 410 Configuration > Log & Report > Email Daily Report

Email Daily Report

General Settings

Enable Email Daily Report

Email Settings

Mail Server: (Outgoing SMTP Server Name or IP Address)

Mail Subject:

Append system name Append date time

Mail From: (Email Address)

Mail To: (Email Address)
 (Email Address)
 (Email Address)
 (Email Address)

SMTP Authentication

User Name:

Password:

Schedule

Time for sending report: (hours) (minutes)

Report Items

System Resource Usage

CPU Usage

Memory Usage

Session Usage

Port Usage

Threat Report

Intrusion Detection Prevention

Anti-Virus

Anti-Spam

Content Filter

Interface Traffic Statistics

Reset counters after sending report successfully

The following table describes the labels in this screen.

Table 210 Configuration > Log & Report > Email Daily Report

LABEL	DESCRIPTION
Enable Email Daily Report	Select this to send reports by e-mail every day.
Mail Server	Type the name or IP address of the outgoing SMTP server.
Mail Subject	Type the subject line for the outgoing e-mail. Select Append system name to add the ZyWALL's system name to the subject. Select Append date time to add the ZyWALL's system date and time to the subject.
Mail From	Type the e-mail address from which the outgoing e-mail is delivered. This address is used in replies.
Mail To	Type the e-mail address (or addresses) to which the outgoing e-mail is delivered.
SMTP Authentication	Select this check box if it is necessary to provide a user name and password to the SMTP server.
User Name	This box is effective when you select the SMTP Authentication check box. Type the user name to provide to the SMTP server when the log is e-mailed.
Password	This box is effective when you select the SMTP Authentication check box. Type the password to provide to the SMTP server when the log is e-mailed.
Send Report Now	Click this button to have the ZyWALL send the daily e-mail report immediately.
Time for sending report	Select the time of day (hours and minutes) when the log is e-mailed. Use 24-hour notation.
Report Items	Select the information to include in the report. Select Reset counters after sending report successfully if you only want to see statistics for a 24 hour period.
Reset All Counters	Click this to discard all report data and start all of the counters over at zero.
Apply	Click Apply to save your changes back to the ZyWALL.
Reset	Click Reset to return the screen to its last-saved settings.

44.3 Log Setting Screens

The **Log Setting** screens control log messages and alerts. A log message stores the information for viewing (for example, in the **View Log** tab) or regular e-mailing later, and an alert is e-mailed immediately. Usually, alerts are used for events that require more serious attention, such as system errors and attacks.

The ZyWALL provides a system log and supports e-mail profiles and remote syslog servers. The system log is available on the **View Log** tab, the e-mail profiles are used to mail log messages to the specified destinations, and the other four logs are stored on specified syslog servers.

The **Log Setting** tab also controls what information is saved in each log. For the system log, you can also specify which log messages are e-mailed, where they are e-mailed, and how often they are e-mailed.

For alerts, the **Log Settings** tab controls which events generate alerts and where alerts are e-mailed.

The **Log Settings Summary** screen provides a summary of all the settings. You can use the **Log Settings Edit** screen to maintain the detailed settings (such as log categories, e-mail addresses, server names, etc.) for any log. Alternatively, if you want to edit what events is included in each log, you can also use the **Active Log Summary** screen to edit this information for all logs at the same time.

44.3.1 Log Setting Summary

To access this screen, click **Configuration > Log & Report > Log Setting**.

Figure 411 Configuration > Log & Report > Log Setting

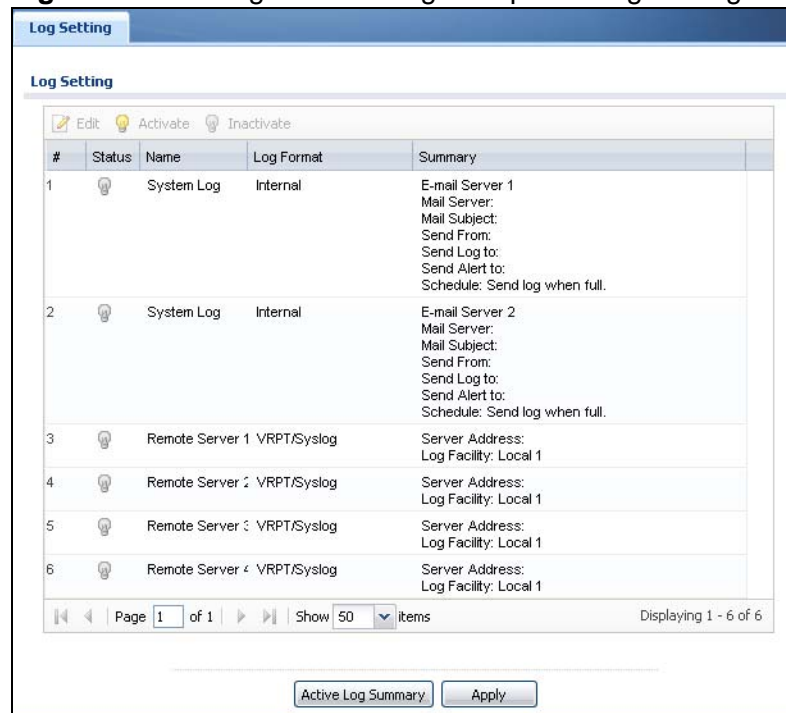

The following table describes the labels in this screen.

Table 211 Configuration > Log & Report > Log Setting

LABEL	DESCRIPTION
Edit	Double-click an entry or select it and click Edit to open a screen where you can modify the entry's settings.
Activate	To turn on an entry, select it and click Activate .
Inactivate	To turn off an entry, select it and click Inactivate .

Table 211 Configuration > Log & Report > Log Setting (continued)

LABEL	DESCRIPTION
#	This field is a sequential value, and it is not associated with a specific log.
Name	This field displays the name of the log (system log or one of the remote servers).
Log Format	This field displays the format of the log. Internal - system log; you can view the log on the View Log tab. VRPT/Syslog - ZyXEL's Vantage Report, syslog-compatible format. CEF/Syslog - Common Event Format, syslog-compatible format.
Summary	This field is a summary of the settings for each log. Please see Section 44.3.2 on page 683 for more information.
Active Log Summary	Click this button to open the Active Log Summary Edit screen.
Apply	Click this button to save your changes (activate and deactivate logs) and make them take effect.

44.3.2 Edit System Log Settings

The **Log Settings Edit** screen controls the detailed settings for each log in the system log (which includes the e-mail profiles). Go to the **Log Settings Summary** screen (see [Section 44.3.1 on page 682](#)), and click the system log **Edit** icon.

Figure 412 Configuration > Log & Report > Log Setting > Edit (System Log)

E-mail Server 1

Active

Mail Server: (Outgoing SMTP Server Name or IP Address)

Mail Subject:

Send From: (E-Mail Address)

Send Log to: (E-Mail Address)

Send Alerts to: (E-Mail Address)

Sending Log:

Day For Sending Log:

Time For Sending Log:

SMTP Authentication

User Name:

Password:

E-mail Server 2

Active

Mail Server: (Outgoing SMTP Server Name or IP Address)

Mail Subject:

Send From: (E-Mail Address)

Send Log to: (E-Mail Address)

Send Alerts to: (E-Mail Address)

Sending Log:

Day For Sending Log:

Time For Sending Log:

SMTP Authentication

User Name:

Password:

Active Log and Alert

System Log | E-mail Server 1 | E-mail Server 2

#	Log Category	System Log	E-mail Server 1	E-mail Server 2
1	Account	<input checked="" type="checkbox"/>	<input checked="" type="checkbox"/>	<input checked="" type="checkbox"/>
2	ADP	<input checked="" type="checkbox"/>	<input checked="" type="checkbox"/>	<input checked="" type="checkbox"/>
3	Anti-Spam	<input checked="" type="checkbox"/>	<input checked="" type="checkbox"/>	<input checked="" type="checkbox"/>
4	Anti-Virus	<input checked="" type="checkbox"/>	<input checked="" type="checkbox"/>	<input checked="" type="checkbox"/>
5	Application Patrol	<input checked="" type="checkbox"/>	<input checked="" type="checkbox"/>	<input checked="" type="checkbox"/>
6	Auth. Policy	<input checked="" type="checkbox"/>	<input checked="" type="checkbox"/>	<input checked="" type="checkbox"/>
7	Blocked web sites	<input checked="" type="checkbox"/>	<input checked="" type="checkbox"/>	<input checked="" type="checkbox"/>
8	Built-in Service	<input checked="" type="checkbox"/>	<input checked="" type="checkbox"/>	<input checked="" type="checkbox"/>
9	Cellular	<input checked="" type="checkbox"/>	<input checked="" type="checkbox"/>	<input checked="" type="checkbox"/>
10	Connectivity Check	<input checked="" type="checkbox"/>	<input checked="" type="checkbox"/>	<input checked="" type="checkbox"/>
11	Content Filter	<input checked="" type="checkbox"/>	<input checked="" type="checkbox"/>	<input checked="" type="checkbox"/>
12	Content Filter Forward	<input checked="" type="checkbox"/>	<input type="checkbox"/>	<input type="checkbox"/>
13	Daily Report	<input checked="" type="checkbox"/>	<input checked="" type="checkbox"/>	<input checked="" type="checkbox"/>
14	Default	<input checked="" type="checkbox"/>	<input checked="" type="checkbox"/>	<input checked="" type="checkbox"/>
15	Device HA	<input checked="" type="checkbox"/>	<input checked="" type="checkbox"/>	<input checked="" type="checkbox"/>
16	DHCP	<input checked="" type="checkbox"/>	<input checked="" type="checkbox"/>	<input checked="" type="checkbox"/>
17	Dial-in Mgmt.	<input checked="" type="checkbox"/>	<input checked="" type="checkbox"/>	<input checked="" type="checkbox"/>
18	EPS	<input checked="" type="checkbox"/>	<input checked="" type="checkbox"/>	<input checked="" type="checkbox"/>
19	File Manager	<input checked="" type="checkbox"/>	<input checked="" type="checkbox"/>	<input checked="" type="checkbox"/>
20	Firewall	<input checked="" type="checkbox"/>	<input checked="" type="checkbox"/>	<input checked="" type="checkbox"/>
21	Force Authentication	<input checked="" type="checkbox"/>	<input checked="" type="checkbox"/>	<input checked="" type="checkbox"/>
22	Forward web sites	<input checked="" type="checkbox"/>	<input type="checkbox"/>	<input type="checkbox"/>
23	IDP	<input checked="" type="checkbox"/>	<input checked="" type="checkbox"/>	<input checked="" type="checkbox"/>
24	IKE	<input checked="" type="checkbox"/>	<input checked="" type="checkbox"/>	<input checked="" type="checkbox"/>
25	Interface	<input checked="" type="checkbox"/>	<input checked="" type="checkbox"/>	<input checked="" type="checkbox"/>
26	IP-MAC Binding	<input checked="" type="checkbox"/>	<input checked="" type="checkbox"/>	<input checked="" type="checkbox"/>
27	IPSec	<input checked="" type="checkbox"/>	<input checked="" type="checkbox"/>	<input checked="" type="checkbox"/>
28	L2TP Over IPSec	<input checked="" type="checkbox"/>	<input checked="" type="checkbox"/>	<input checked="" type="checkbox"/>
29	myZyWALL.com	<input checked="" type="checkbox"/>	<input checked="" type="checkbox"/>	<input checked="" type="checkbox"/>
30	NAT	<input checked="" type="checkbox"/>	<input checked="" type="checkbox"/>	<input checked="" type="checkbox"/>
31	PD	<input checked="" type="checkbox"/>	<input checked="" type="checkbox"/>	<input checked="" type="checkbox"/>
32	Policy Route	<input checked="" type="checkbox"/>	<input checked="" type="checkbox"/>	<input checked="" type="checkbox"/>
33	Port Grouping	<input checked="" type="checkbox"/>	<input checked="" type="checkbox"/>	<input checked="" type="checkbox"/>
34	Routing Protocol	<input checked="" type="checkbox"/>	<input checked="" type="checkbox"/>	<input checked="" type="checkbox"/>
35	Sessions Limit	<input checked="" type="checkbox"/>	<input checked="" type="checkbox"/>	<input checked="" type="checkbox"/>
36	SSL VPN	<input checked="" type="checkbox"/>	<input checked="" type="checkbox"/>	<input checked="" type="checkbox"/>
37	System	<input checked="" type="checkbox"/>	<input checked="" type="checkbox"/>	<input checked="" type="checkbox"/>
38	User	<input checked="" type="checkbox"/>	<input checked="" type="checkbox"/>	<input checked="" type="checkbox"/>
39	Virtual CHM	<input checked="" type="checkbox"/>	<input checked="" type="checkbox"/>	<input checked="" type="checkbox"/>
40	Warning web sites	<input checked="" type="checkbox"/>	<input checked="" type="checkbox"/>	<input checked="" type="checkbox"/>
41	Wireless LAN	<input checked="" type="checkbox"/>	<input checked="" type="checkbox"/>	<input checked="" type="checkbox"/>
42	ZySH	<input checked="" type="checkbox"/>	<input checked="" type="checkbox"/>	<input checked="" type="checkbox"/>

Page 1 of 1 | Show 50 items | Displaying 1 - 42 of 42

Log Consolidation

Active

Log Consolidation Interval (seconds): (10 - 600)

OK Cancel

The following table describes the labels in this screen.

Table 212 Configuration > Log & Report > Log Setting > Edit (System Log)

LABEL	DESCRIPTION
E-Mail Server 1/2	
Active	Select this to send log messages and alerts according to the information in this section. You specify what kinds of log messages are included in log information and what kinds of log messages are included in alerts in the Active Log and Alert section.
Mail Server	Type the name or IP address of the outgoing SMTP server.
Mail Subject	Type the subject line for the outgoing e-mail.
Send From	Type the e-mail address from which the outgoing e-mail is delivered. This address is used in replies.
Send Log To	Type the e-mail address to which the outgoing e-mail is delivered.
Send Alerts To	Type the e-mail address to which alerts are delivered.
Sending Log	Select how often log information is e-mailed. Choices are: When Full, Hourly and When Full, Daily and When Full, and Weekly and When Full.
Day for Sending Log	This field is available if the log is e-mailed weekly. Select the day of the week the log is e-mailed.
Time for Sending Log	This field is available if the log is e-mailed weekly or daily. Select the time of day (hours and minutes) when the log is e-mailed. Use 24-hour notation.
SMTP Authentication	Select this check box if it is necessary to provide a user name and password to the SMTP server.
User Name	This box is effective when you select the SMTP Authentication check box. Type the user name to provide to the SMTP server when the log is e-mailed.
Password	This box is effective when you select the SMTP Authentication check box. Type the password to provide to the SMTP server when the log is e-mailed.
Active Log and Alert	
System log	Use the System Log drop-down list to change the log settings for all of the log categories. disable all logs (red X) - do not log any information for any category for the system log or e-mail any logs to e-mail server 1 or 2. enable normal logs (green check mark) - create log messages and alerts for all categories for the system log. If e-mail server 1 or 2 also has normal logs enabled, the ZyWALL will e-mail logs to them. enable normal logs and debug logs (yellow check mark) - create log messages, alerts, and debugging information for all categories. The ZyWALL does not e-mail debugging information, even if this setting is selected.

Table 212 Configuration > Log & Report > Log Setting > Edit (System Log)

LABEL	DESCRIPTION
E-mail Server 1	<p>Use the E-Mail Server 1 drop-down list to change the settings for e-mailing logs to e-mail server 1 for all log categories.</p> <p>Using the System Log drop-down list to disable all logs overrides your e-mail server 1 settings.</p> <p>enable normal logs (green check mark) - e-mail log messages for all categories to e-mail server 1.</p> <p>enable alert logs (red exclamation point) - e-mail alerts for all categories to e-mail server 1.</p>
E-mail Server 2	<p>Use the E-Mail Server 2 drop-down list to change the settings for e-mailing logs to e-mail server 2 for all log categories.</p> <p>Using the System Log drop-down list to disable all logs overrides your e-mail server 2 settings.</p> <p>enable normal logs (green check mark) - e-mail log messages for all categories to e-mail server 2.</p> <p>enable alert logs (red exclamation point) - e-mail alerts for all categories to e-mail server 2.</p>
#	This field is a sequential value, and it is not associated with a specific address.
Log Category	This field displays each category of messages. It is the same value used in the Display and Category fields in the View Log tab. The Default category includes debugging messages generated by open source software.
System log	<p>Select which events you want to log by Log Category. There are three choices:</p> <p>disable all logs (red X) - do not log any information from this category</p> <p>enable normal logs (green checkmark) - create log messages and alerts from this category</p> <p>enable normal logs and debug logs (yellow check mark) - create log messages, alerts, and debugging information from this category; the ZyWALL does not e-mail debugging information, however, even if this setting is selected.</p>
E-mail Server 1	Select whether each category of events should be included in the log messages when it is e-mailed (green check mark) and/or in alerts (red exclamation point) for the e-mail settings specified in E-Mail Server 1 . The ZyWALL does not e-mail debugging information, even if it is recorded in the System log .
E-mail Server 2	Select whether each category of events should be included in log messages when it is e-mailed (green check mark) and/or in alerts (red exclamation point) for the e-mail settings specified in E-Mail Server 2 . The ZyWALL does not e-mail debugging information, even if it is recorded in the System log .
Log Consolidation	

Table 212 Configuration > Log & Report > Log Setting > Edit (System Log)

LABEL	DESCRIPTION
Active	Select this to activate log consolidation. Log consolidation aggregates multiple log messages that arrive within the specified Log Consolidation Interval . In the View Log tab, the text "[count= <i>x</i>]", where <i>x</i> is the number of original log messages, is appended at the end of the Message field, when multiple log messages were aggregated.
Log Consolidation Interval	Type how often, in seconds, to consolidate log information. If the same log message appears multiple times, it is aggregated into one log message with the text "[count= <i>x</i>]", where <i>x</i> is the number of original log messages, appended at the end of the Message field.
OK	Click this to save your changes and return to the previous screen.
Cancel	Click this to return to the previous screen without saving your changes.

44.3.3 Edit Remote Server Log Settings

The **Log Settings Edit** screen controls the detailed settings for each log in the remote server (syslog). Go to the **Log Settings Summary** screen (see [Section 44.3.1 on page 682](#)), and click a remote server **Edit** icon.

Figure 413 Configuration > Log & Report > Log Setting > Edit (Remote Server)

Log Settings for Remote Server

Active

Log Format:

Server Address: (Server Name or IP Address)

Log Facility:

Active Log

#	Log Category	Selection
1	Account	<input checked="" type="radio"/> <input type="radio"/> <input type="radio"/>
2	ADP	<input checked="" type="radio"/> <input type="radio"/> <input type="radio"/>
3	Anti-Spam	<input checked="" type="radio"/> <input type="radio"/> <input type="radio"/>
4	Anti-Virus	<input checked="" type="radio"/> <input type="radio"/> <input type="radio"/>
5	Application Patrol	<input checked="" type="radio"/> <input type="radio"/> <input type="radio"/>
6	Auth. Policy	<input checked="" type="radio"/> <input type="radio"/> <input type="radio"/>
7	Blocked web sites	<input checked="" type="radio"/> <input type="radio"/> <input type="radio"/>
8	Built-in Service	<input checked="" type="radio"/> <input type="radio"/> <input type="radio"/>
9	Cellular	<input checked="" type="radio"/> <input type="radio"/> <input type="radio"/>
10	Connectivity Check	<input checked="" type="radio"/> <input type="radio"/> <input type="radio"/>
11	Content Filter	<input checked="" type="radio"/> <input type="radio"/> <input type="radio"/>
12	Content Filter Forward	<input checked="" type="radio"/> <input type="radio"/> <input type="radio"/>
13	Daily Report	<input checked="" type="radio"/> <input type="radio"/> <input type="radio"/>
14	Default	<input checked="" type="radio"/> <input type="radio"/> <input type="radio"/>
15	Device HA	<input checked="" type="radio"/> <input type="radio"/> <input type="radio"/>
16	DHCP	<input checked="" type="radio"/> <input type="radio"/> <input type="radio"/>
17	Dial-in Mgmt.	<input checked="" type="radio"/> <input type="radio"/> <input type="radio"/>
18	EPS	<input checked="" type="radio"/> <input type="radio"/> <input type="radio"/>
19	File Manager	<input checked="" type="radio"/> <input type="radio"/> <input type="radio"/>
20	Firewall	<input checked="" type="radio"/> <input type="radio"/> <input type="radio"/>
21	Force Authentication	<input checked="" type="radio"/> <input type="radio"/> <input type="radio"/>
22	Forward web sites	<input checked="" type="radio"/> <input type="radio"/> <input type="radio"/>
23	IDP	<input checked="" type="radio"/> <input type="radio"/> <input type="radio"/>
24	IKE	<input checked="" type="radio"/> <input type="radio"/> <input type="radio"/>
25	Interface	<input checked="" type="radio"/> <input type="radio"/> <input type="radio"/>
26	Interface Statistics	<input checked="" type="radio"/> <input type="radio"/> <input type="radio"/>
27	IP-MAC Binding	<input checked="" type="radio"/> <input type="radio"/> <input type="radio"/>
28	IPSec	<input checked="" type="radio"/> <input type="radio"/> <input type="radio"/>
29	L2TP Over IPSec	<input checked="" type="radio"/> <input type="radio"/> <input type="radio"/>
30	myZyXEL.com	<input checked="" type="radio"/> <input type="radio"/> <input type="radio"/>
31	NAT	<input checked="" type="radio"/> <input type="radio"/> <input type="radio"/>
32	PKI	<input checked="" type="radio"/> <input type="radio"/> <input type="radio"/>
33	Policy Route	<input checked="" type="radio"/> <input type="radio"/> <input type="radio"/>
34	Port Grouping	<input checked="" type="radio"/> <input type="radio"/> <input type="radio"/>
35	Routing Protocol	<input checked="" type="radio"/> <input type="radio"/> <input type="radio"/>
36	Sessions Limit	<input checked="" type="radio"/> <input type="radio"/> <input type="radio"/>
37	SSL VPN	<input checked="" type="radio"/> <input type="radio"/> <input type="radio"/>

OK Cancel

The following table describes the labels in this screen.

Table 213 Configuration > Log & Report > Log Setting > Edit (Remote Server)

LABEL	DESCRIPTION
Log Settings for Remote Server	
Active	Select this check box to send log information according to the information in this section. You specify what kinds of messages are included in log information in the Active Log section.
Log Format	This field displays the format of the log information. It is read-only. VRPT/Syslog - ZyXEL's Vantage Report, syslog-compatible format. CEF/Syslog - Common Event Format, syslog-compatible format.
Server Address	Type the server name or the IP address of the syslog server to which to send log information.
Log Facility	Select a log facility. The log facility allows you to log the messages to different files in the syslog server. Please see the documentation for your syslog program for more information.
Active Log	
Selection	Use the Selection drop-down list to change the log settings for all of the log categories. disable all logs (red X) - do not send the remote server logs for any log category. enable normal logs (green check mark) - send the remote server log messages and alerts for all log categories. enable normal logs and debug logs (yellow check mark) - send the remote server log messages, alerts, and debugging information for all log categories.
#	This field is a sequential value, and it is not associated with a specific address.
Log Category	This field displays each category of messages. It is the same value used in the Display and Category fields in the View Log tab. The Default category includes debugging messages generated by open source software.
Selection	Select what information you want to log from each Log Category (except All Logs ; see below). Choices are: disable all logs (red X) - do not log any information from this category enable normal logs (green checkmark) - log regular information and alerts from this category enable normal logs and debug logs (yellow check mark) - log regular information, alerts, and debugging information from this category
OK	Click this to save your changes and return to the previous screen.
Cancel	Click this to return to the previous screen without saving your changes.

44.3.4 Active Log Summary Screen

The **Active Log Summary** screen allows you to view and to edit what information is included in the system log, e-mail profiles, and remote servers at the same time. It does not let you change other log settings (for example, where and how often log information is e-mailed or remote server names). To access this screen, go to the **Log Settings Summary** screen (see [Section 44.3.1 on page 682](#)), and click the **Active Log Summary** button.

Figure 414 Active Log Summary

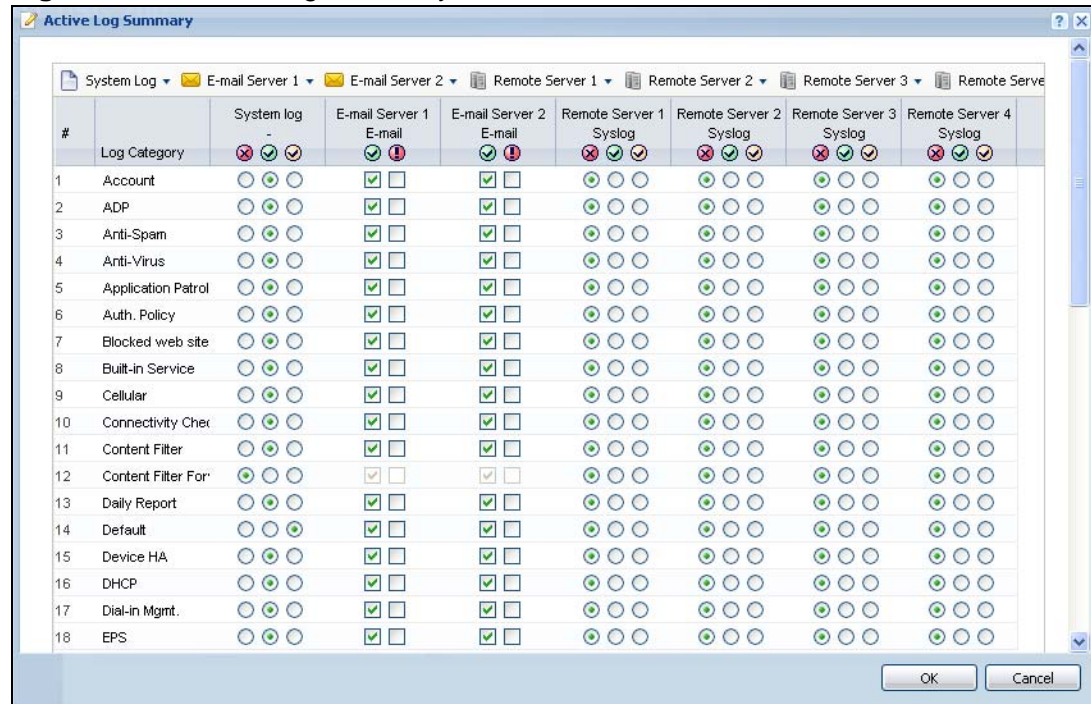

This screen provides a different view and a different way of indicating which messages are included in each log and each alert. Please see [Section 44.3.2 on page 683](#), where this process is discussed. (The **Default** category includes debugging messages generated by open source software.)

The following table describes the fields in this screen.

Table 214 Configuration > Log & Report > Log Setting > Active Log Summary

LABEL	DESCRIPTION
System log	<p>Use the System Log drop-down list to change the log settings for all of the log categories.</p> <p>disable all logs (red X) - do not log any information for any category for the system log or e-mail any logs to e-mail server 1 or 2.</p> <p>enable normal logs (green check mark) - create log messages and alerts for all categories for the system log. If e-mail server 1 or 2 also has normal logs enabled, the ZyWALL will e-mail logs to them.</p> <p>enable normal logs and debug logs (yellow check mark) - create log messages, alerts, and debugging information for all categories. The ZyWALL does not e-mail debugging information, even if this setting is selected.</p>
E-mail Server 1	<p>Use the E-Mail Server 1 drop-down list to change the settings for e-mailing logs to e-mail server 1 for all log categories.</p> <p>Using the System Log drop-down list to disable all logs overrides your e-mail server 1 settings.</p> <p>enable normal logs (green check mark) - e-mail log messages for all categories to e-mail server 1.</p> <p>enable alert logs (red exclamation point) - e-mail alerts for all categories to e-mail server 1.</p>
E-mail Server 2	<p>Use the E-Mail Server 2 drop-down list to change the settings for e-mailing logs to e-mail server 2 for all log categories.</p> <p>Using the System Log drop-down list to disable all logs overrides your e-mail server 2 settings.</p> <p>enable normal logs (green check mark) - e-mail log messages for all categories to e-mail server 2.</p> <p>enable alert logs (red exclamation point) - e-mail alerts for all categories to e-mail server 2.</p>
Remote Server 1~4	<p>For each remote server, use the Selection drop-down list to change the log settings for all of the log categories.</p> <p>disable all logs (red X) - do not send the remote server logs for any log category.</p> <p>enable normal logs (green check mark) - send the remote server log messages and alerts for all log categories.</p> <p>enable normal logs and debug logs (yellow check mark) - send the remote server log messages, alerts, and debugging information for all log categories.</p>
#	<p>This field is a sequential value, and it is not associated with a specific address.</p>
Log Category	<p>This field displays each category of messages. It is the same value used in the Display and Category fields in the View Log tab. The Default category includes debugging messages generated by open source software.</p>

Table 214 Configuration > Log & Report > Log Setting > Active Log Summary

LABEL	DESCRIPTION
System log	<p>Select which events you want to log by Log Category. There are three choices:</p> <p>disable all logs (red X) - do not log any information from this category</p> <p>enable normal logs (green checkmark) - create log messages and alerts from this category</p> <p>enable normal logs and debug logs (yellow check mark) - create log messages, alerts, and debugging information from this category; the ZyWALL does not e-mail debugging information, however, even if this setting is selected.</p>
E-mail Server 1 E-mail	<p>Select whether each category of events should be included in the log messages when it is e-mailed (green check mark) and/or in alerts (red exclamation point) for the e-mail settings specified in E-Mail Server 1. The ZyWALL does not e-mail debugging information, even if it is recorded in the System log.</p>
E-mail Server 2 E-mail	<p>Select whether each category of events should be included in log messages when it is e-mailed (green check mark) and/or in alerts (red exclamation point) for the e-mail settings specified in E-Mail Server 2. The ZyWALL does not e-mail debugging information, even if it is recorded in the System log.</p>
Remote Server 1~4	<p>For each remote server, select what information you want to log from each Log Category (except All Logs; see below). Choices are:</p> <p>disable all logs (red X) - do not log any information from this category</p> <p>enable normal logs (green checkmark) - log regular information and alerts from this category</p> <p>enable normal logs and debug logs (yellow check mark) - log regular information, alerts, and debugging information from this category</p>
OK	Click this to save your changes and return to the previous screen.
Cancel	Click this to return to the previous screen without saving your changes.

File Manager

45.1 Overview

Configuration files define the ZyWALL's settings. Shell scripts are files of commands that you can store on the ZyWALL and run when you need them. You can apply a configuration file or run a shell script without the ZyWALL restarting. You can store multiple configuration files and shell script files on the ZyWALL. You can edit configuration files or shell scripts in a text editor and upload them to the ZyWALL. Configuration files use a .conf extension and shell scripts use a .zysh extension.

45.1.1 What You Can Do in this Chapter

- Use the **Configuration File** screen (see [Section 45.2 on page 696](#)) to store and name configuration files. You can also download configuration files from the ZyWALL to your computer and upload configuration files from your computer to the ZyWALL.
- Use the **Firmware Package** screen (see [Section 45.3 on page 700](#)) to check your current firmware version and upload firmware to the ZyWALL.
- Use the **Shell Script** screen (see [Section 45.4 on page 702](#)) to store, name, download, upload and run shell script files.

45.1.2 What you Need to Know

Configuration Files and Shell Scripts

When you apply a configuration file, the ZyWALL uses the factory default settings for any features that the configuration file does not include. When you run a shell script, the ZyWALL only applies the commands that it contains. Other settings do not change.

These files have the same syntax, which is also identical to the way you run CLI commands manually. An example is shown below.

Figure 415 Configuration File / Shell Script: Example

```
# enter configuration mode
configure terminal
# change administrator password
username admin password 4321 user-type admin
# configure ge3
interface ge3
ip address 172.23.37.240 255.255.255.0
ip gateway 172.23.37.254 metric 1
exit
# create address objects for remote management / to-ZyWALL firewall rules
# use the address group in case we want to open up remote management later
address-object TW_SUBNET 172.23.37.0/24
object-group address TW_TEAM
address-object TW_SUBNET
exit
# enable Telnet access (not enabled by default, unlike other services)
ip telnet server
# open WAN-to-ZyWALL firewall for TW_TEAM for remote management
firewall WAN ZyWALL insert 4
sourceip TW_TEAM
service TELNET
action allow
exit
write
```

While configuration files and shell scripts have the same syntax, the ZyWALL applies configuration files differently than it runs shell scripts. This is explained below.

Table 215 Configuration Files and Shell Scripts in the ZyWALL

Configuration Files (.conf)	Shell Scripts (.zysh)
<ul style="list-style-type: none"> Resets to default configuration. Goes into CLI Configuration mode. Runs the commands in the configuration file. 	<ul style="list-style-type: none"> Goes into CLI Privilege mode. Runs the commands in the shell script.

You have to run the example in [Figure 415 on page 694](#) as a shell script because the first command is run in **Privilege** mode. If you remove the first command, you have to run the example as a configuration file because the rest of the commands are executed in **Configuration** mode.

Comments in Configuration Files or Shell Scripts

In a configuration file or shell script, use “#” or “!” as the first character of a command line to have the ZyWALL treat the line as a comment.

Your configuration files or shell scripts can use “exit” or a command line consisting of a single “!” to have the ZyWALL exit sub command mode.

Note: “exit” or “!” must follow sub commands if it is to make the ZyWALL exit sub command mode.

Line 3 in the following example exits sub command mode.

```
interface gel
ip address dhcp
!
```

Lines 1 and 3 in the following example are comments and line 4 exits sub command mode.

```
!
interface gel
# this interface is a DHCP client
!
```

Lines 1 and 2 are comments. Line 5 exits sub command mode.

```
! this is from Joe
# on 2008/04/05
interface gel
ip address dhcp
!
```

Errors in Configuration Files or Shell Scripts

When you apply a configuration file or run a shell script, the ZyWALL processes the file line-by-line. The ZyWALL checks the first line and applies the line if no errors are detected. Then it continues with the next line. If the ZyWALL finds an error, it stops applying the configuration file or shell script and generates a log.

You can change the way a configuration file or shell script is applied. Include `setenv stop-on-error off` in the configuration file or shell script. The ZyWALL ignores any errors in the configuration file or shell script and applies all of the valid commands. The ZyWALL still generates a log for any errors.

45.2 The Configuration File Screen

Click **Maintenance > File Manager > Configuration File** to open the **Configuration File** screen. Use the **Configuration File** screen to store, run, and name configuration files. You can also download configuration files from the ZyWALL to your computer and upload configuration files from your computer to the ZyWALL.

Once your ZyWALL is configured and functioning properly, it is highly recommended that you back up your configuration file before making further configuration changes. The backup configuration file will be useful in case you need to return to your previous settings.

Configuration File Flow at Restart

- If there is not a **startup-config.conf** when you restart the ZyWALL (whether through a management interface or by physically turning the power off and back on), the ZyWALL uses the **system-default.conf** configuration file with the ZyWALL's default settings.
- If there is a **startup-config.conf**, the ZyWALL checks it for errors and applies it. If there are no errors, the ZyWALL uses it and copies it to the **lastgood.conf** configuration file as a back up file. If there is an error, the ZyWALL generates a log and copies the **startup-config.conf** configuration file to the **startup-config-bad.conf** configuration file and tries the existing **lastgood.conf** configuration file. If there isn't a **lastgood.conf** configuration file or it also has an error, the ZyWALL applies the **system-default.conf** configuration file.
- You can change the way the **startup-config.conf** file is applied. Include the `setenv-startup stop-on-error off` command. The ZyWALL ignores any errors in the **startup-config.conf** file and applies all of the valid commands. The ZyWALL still generates a log for any errors.

Figure 416 Maintenance > File Manager > Configuration File

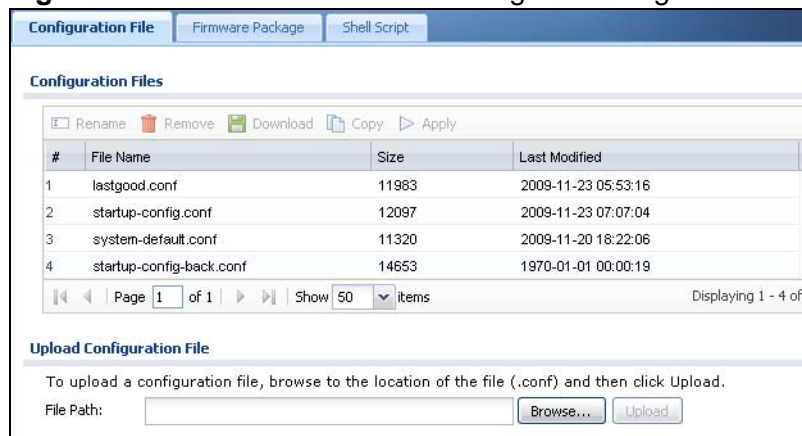

Do not turn off the ZyWALL while configuration file upload is in progress.

The following table describes the labels in this screen.

Table 216 Maintenance > File Manager > Configuration File

LABEL	DESCRIPTION
Rename	<p>Use this button to change the label of a configuration file on the ZyWALL. You can only rename manually saved configuration files. You cannot rename the lastgood.conf, system-default.conf and startup-config.conf files.</p> <p>You cannot rename a configuration file to the name of another configuration file in the ZyWALL.</p> <p>Click a configuration file's row to select it and click Rename to open the Rename File screen.</p> <p>Figure 417 Maintenance > File Manager > Configuration File > Rename</p>  <p>Specify the new name for the configuration file. Use up to 25 characters (including a-zA-Z0-9;`~!@#\$%^&()_+[]{}',.= -).</p> <p>Click OK to save the duplicate or click Cancel to close the screen without saving a duplicate of the configuration file.</p>
Remove	<p>Click a configuration file's row to select it and click Remove to delete it from the ZyWALL. You can only delete manually saved configuration files. You cannot delete the system-default.conf, startup-config.conf and lastgood.conf files.</p> <p>A pop-up window asks you to confirm that you want to delete the configuration file. Click OK to delete the configuration file or click Cancel to close the screen without deleting the configuration file.</p>
Download	<p>Click a configuration file's row to select it and click Download to save the configuration to your computer.</p>

Table 216 Maintenance > File Manager > Configuration File (continued)

LABEL	DESCRIPTION
Copy	<p>Use this button to save a duplicate of a configuration file on the ZyWALL.</p> <p>Click a configuration file's row to select it and click Copy to open the Copy File screen.</p> <p>Figure 418 Maintenance > File Manager > Configuration File > Copy</p>  <p>Specify a name for the duplicate configuration file. Use up to 25 characters (including a-zA-Z0-9;~!@#\$%^&()_+[]{}',.= -).</p> <p>Click OK to save the duplicate or click Cancel to close the screen without saving a duplicate of the configuration file.</p>

Table 216 Maintenance > File Manager > Configuration File (continued)

LABEL	DESCRIPTION
Apply	<p>Use this button to have the ZyWALL use a specific configuration file.</p> <p>Click a configuration file's row to select it and click Apply to have the ZyWALL use that configuration file. The ZyWALL does not have to restart in order to use a different configuration file, although you will need to wait for a few minutes while the system reconfigures.</p> <p>The following screen gives you options for what the ZyWALL is to do if it encounters an error in the configuration file.</p> <p>Figure 419 Maintenance > File Manager > Configuration File > Apply</p>  <p>Immediately stop applying the configuration file - this is not recommended because it would leave the rest of the configuration blank. If the interfaces were not configured before the first error, the console port may be the only way to access the device.</p> <p>Immediately stop applying the configuration file and roll back to the previous configuration - this gets the ZyWALL started with a fully valid configuration file as quickly as possible.</p> <p>Ignore errors and finish applying the configuration file - this applies the valid parts of the configuration file and generates error logs for all of the configuration file's errors. This lets the ZyWALL apply most of your configuration and you can refer to the logs for what to fix.</p> <p>Ignore errors and finish applying the configuration file and then roll back to the previous configuration - this applies the valid parts of the configuration file, generates error logs for all of the configuration file's errors, and starts the ZyWALL with a fully valid configuration file.</p> <p>Click OK to have the ZyWALL start applying the configuration file or click Cancel to close the screen</p>
#	<p>This column displays the number for each configuration file entry. This field is a sequential value, and it is not associated with a specific address. The total number of configuration files that you can save depends on the sizes of the configuration files and the available flash storage space.</p>

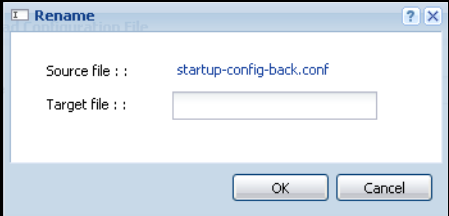
Table 216 Maintenance > File Manager > Configuration File (continued)

LABEL	DESCRIPTION
File Name	<p>This column displays the label that identifies a configuration file.</p> <p>You cannot delete the following configuration files or change their file names.</p> <p>The system-default.conf file contains the ZyWALL's default settings. Select this file and click Apply to reset all of the ZyWALL settings to the factory defaults. This configuration file is included when you upload a firmware package.</p> <p>The startup-config.conf file is the configuration file that the ZyWALL is currently using. If you make and save changes during your management session, the changes are applied to this configuration file. The ZyWALL applies configuration changes made in the Web Configurator to the configuration file when you click Apply or OK. It applies configuration changes made via commands when you use the <code>write</code> command.</p> <p>The lastgood.conf is the most recently used (valid) configuration file that was saved when the device last restarted. If you upload and apply a configuration file with an error, you can apply <code>lastgood.conf</code> to return to a valid configuration.</p>
Size	This column displays the size (in KB) of a configuration file.
Last Modified	This column displays the date and time that the individual configuration files were last changed or saved.
Upload Configuration File	<p>The bottom part of the screen allows you to upload a new or previously saved configuration file from your computer to your ZyWALL.</p> <p>You cannot upload a configuration file named system-default.conf or lastgood.conf.</p> <p>If you upload startup-config.conf, it will replace the current configuration and immediately apply the new settings.</p>
File Path	Type in the location of the file you want to upload in this field or click Browse ... to find it.
Browse...	<p>Click Browse... to find the <code>.conf</code> file you want to upload. The configuration file must use a <code>.conf</code> filename extension. You will receive an error message if you try to upload a file of a different format. Remember that you must decompress compressed (<code>.zip</code>) files before you can upload them.</p>
Upload	Click Upload to begin the upload process. This process may take up to two minutes.

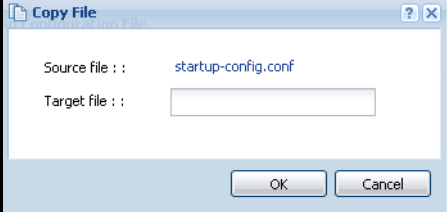
45.3 The Firmware Package Screen

Click **Maintenance > File Manager > Firmware Package** to open the **Firmware Package** screen. Use the **Firmware Package** screen to check your current firmware version and upload firmware to the ZyWALL.

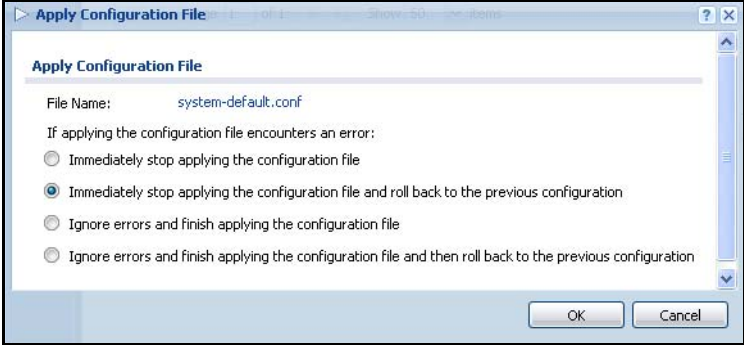
Note: The Web Configurator is the recommended method for uploading firmware. You only need to use the command line interface if you need to recover the firmware. See the CLI Reference Guide for how to determine if you need to recover the firmware and how to recover it.

Find the firmware package at www.zyxel.com in a file that (usually) uses the system model name with a .bin extension, for example, "zywall.bin".

The firmware update can take up to five minutes. Do not turn off or reset the ZyWALL while the firmware update is in progress!

Figure 420 Maintenance > File Manager > Firmware Package

The following table describes the labels in this screen.

Table 217 Maintenance > File Manager > Firmware Package

LABEL	DESCRIPTION
Boot Module	This is the version of the boot module that is currently on the ZyWALL.
Current Version	This is the firmware version and the date created.
Released Date	This is the date that the version of the firmware was created.
File Path	Type in the location of the file you want to upload in this field or click Browse ... to find it.
Browse...	Click Browse... to find the .bin file you want to upload. Remember that you must decompress compressed (.zip) files before you can upload them.
Upload	Click Upload to begin the upload process. This process may take up to two minutes.

After you see the **Firmware Upload in Process** screen, wait two minutes before logging into the ZyWALL again.

Figure 421 Firmware Upload In Process



Note: The ZyWALL automatically reboots after a successful upload.

The ZyWALL automatically restarts causing a temporary network disconnect. In some operating systems, you may see the following icon on your desktop.

Figure 422 Network Temporarily Disconnected

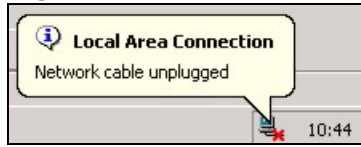

After five minutes, log in again and check your new firmware version in the **HOME** screen.

If the upload was not successful, the following message appears in the status bar at the bottom of the screen.

Figure 423 Firmware Upload Error

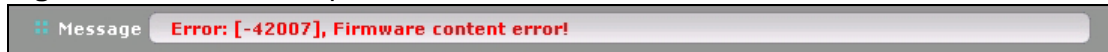

45.4 The Shell Script Screen

Use shell script files to have the ZyWALL use commands that you specify. Use a text editor to create the shell script files. They must use a ".zysh" filename extension.

Click **Maintenance > File Manager > Shell Script** to open the **Shell Script** screen. Use the **Shell Script** screen to store, name, download, upload and run shell script files. You can store multiple shell script files on the ZyWALL at the same time.

Note: You should include `write` commands in your scripts. If you do not use the `write` command, the changes will be lost when the ZyWALL restarts. You could use multiple `write` commands in a long script.

Figure 424 Maintenance > File Manager > Shell Script

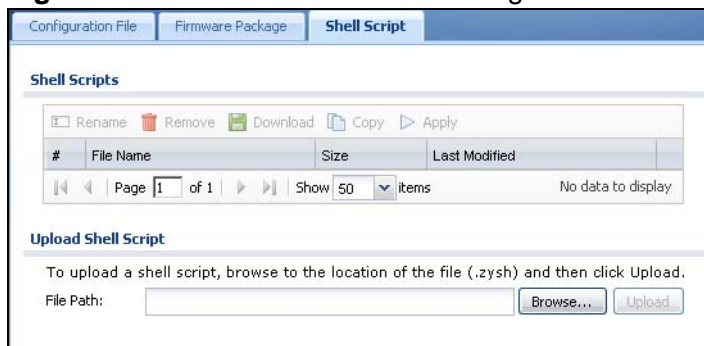

Each field is described in the following table.

Table 218 Maintenance > File Manager > Shell Script

LABEL	DESCRIPTION
Rename	<p>Use this button to change the label of a shell script file on the ZyWALL.</p> <p>You cannot rename a shell script to the name of another shell script in the ZyWALL.</p> <p>Click a shell script's row to select it and click Rename to open the Rename File screen.</p> <p>Figure 425 Maintenance > File Manager > Shell Script > Rename</p>  <p>Specify the new name for the shell script file. Use up to 25 characters (including a-zA-Z0-9;~!@#%&^&()_+[]{}',.-).</p> <p>Click OK to save the duplicate or click Cancel to close the screen without saving a duplicate of the configuration file.</p>
Remove	<p>Click a shell script file's row to select it and click Remove to delete the shell script file from the ZyWALL.</p> <p>A pop-up window asks you to confirm that you want to delete the shell script file. Click OK to delete the shell script file or click Cancel to close the screen without deleting the shell script file.</p>
Download	<p>Click a shell script file's row to select it and click Download to save the configuration to your computer.</p>
Copy	<p>Use this button to save a duplicate of a shell script file on the ZyWALL.</p> <p>Click a shell script file's row to select it and click Copy to open the Copy File screen.</p> <p>Figure 426 Maintenance > File Manager > Shell Script > Copy</p>  <p>Specify a name for the duplicate file. Use up to 25 characters (including a-zA-Z0-9;~!@#%&^&()_+[]{}',.-).</p> <p>Click OK to save the duplicate or click Cancel to close the screen without saving a duplicate of the configuration file.</p>

Table 218 Maintenance > File Manager > Shell Script (continued)

LABEL	DESCRIPTION
Apply	Use this button to have the ZyWALL use a specific shell script file. Click a shell script file's row to select it and click Apply to have the ZyWALL use that shell script file. You may need to wait awhile for the ZyWALL to finish applying the commands.
#	This column displays the number for each shell script file entry.
File Name	This column displays the label that identifies a shell script file.
Size	This column displays the size (in KB) of a shell script file.
Last Modified	This column displays the date and time that the individual shell script files were last changed or saved.
Upload Shell Script	The bottom part of the screen allows you to upload a new or previously saved shell script file from your computer to your ZyWALL.
File Path	Type in the location of the file you want to upload in this field or click Browse ... to find it.
Browse...	Click Browse... to find the .zysh file you want to upload.
Upload	Click Upload to begin the upload process. This process may take up to several minutes.

Diagnostics

46.1 Overview

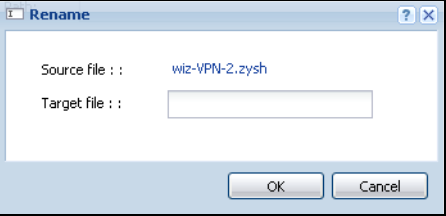
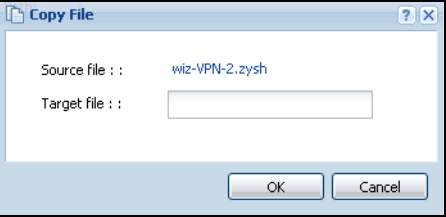
Use the diagnostics screens for troubleshooting.

46.1.1 What You Can Do in this Chapter

- Use the **Maintenance > Diagnostics** screen (see [Section 46.2 on page 705](#)) to generate a file containing the ZyWALL's configuration and diagnostic information if you need to provide it to customer support during troubleshooting.
- Use the **Maintenance > Diagnostics > Packet Capture** screens (see [Section 46.3 on page 707](#)) to capture packets going through the ZyWALL.
- Use the **Maintenance > Diagnostics > Core Dump** screens (see [Section 46.4 on page 712](#)) to have the ZyWALL save a process's core dump to an attached USB storage device if the process terminates abnormally (crashes) so you can send the file to customer support for troubleshooting.
- Use the **Maintenance > Diagnostics > System Log** screens (see [Section 46.5 on page 714](#)) to download files of system logs from a connected USB storage device to your computer.

46.2 The Diagnostic Screen

The **Diagnostic** screen provides an easy way for you to generate a file containing the ZyWALL's configuration and diagnostic information. You may need to send this file to customer support for troubleshooting.

Click **Maintenance > Diagnostics** to open the **Diagnostic** screen.

Figure 427 Maintenance > Diagnostics

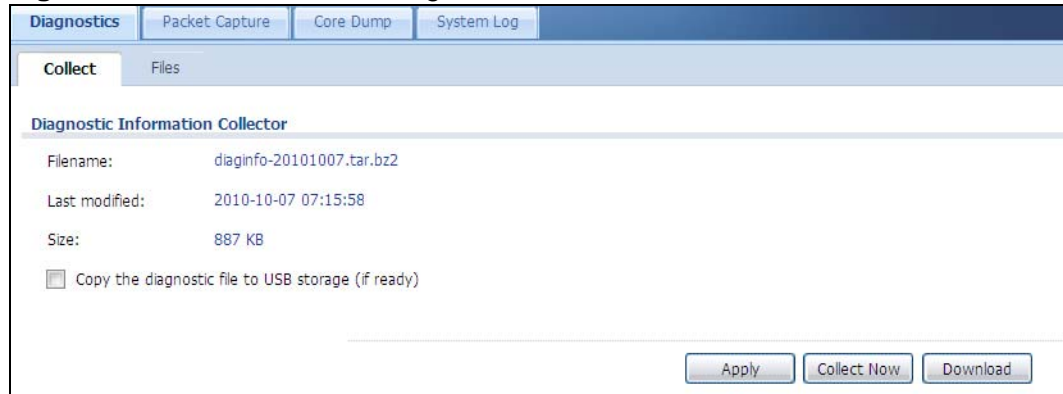

The following table describes the labels in this screen.

Table 219 Maintenance > Diagnostics

LABEL	DESCRIPTION
Filename	This is the name of the most recently created diagnostic file.
Last modified	This is the date and time that the last diagnostic file was created. The format is yyyy-mm-dd hh:mm:ss.
Size	This is the size of the most recently created diagnostic file.
Copy the diagnostic file to USB storage (if ready)	Select this to have the ZyWALL create an extra copy of the diagnostic file to a connected USB storage device.
Apply	Click Apply to save your changes.
Collect Now	Click this to have the ZyWALL create a new diagnostic file.
Download	Click this to save the most recent diagnostic file to a computer.

46.2.1 The Diagnostics Files Screen

Click **Maintenance > Diagnostics > Files** to open the diagnostic files screen. This screen lists the files of diagnostic information the ZyWALL has collected and stored in a connected USB storage device. You may need to send these files to customer support for troubleshooting.

Figure 428 Maintenance > Diagnostics > Files

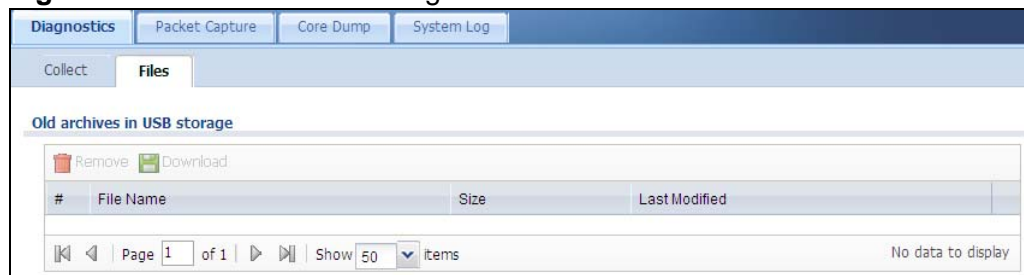

The following table describes the labels in this screen.

Table 220 Maintenance > Diagnostics > Files

LABEL	DESCRIPTION
Remove	Select files and click Remove to delete them from the ZyWALL. Use the [Shift] and/or [Ctrl] key to select multiple files. A pop-up window asks you to confirm that you want to delete.
Download	Click a file to select it and click Download to save it to your computer.
#	This column displays the number for each file entry. The total number of files that you can save depends on the file sizes and the available storage space.
File Name	This column displays the label that identifies the file.
Size	This column displays the size (in bytes) of a file.
Last Modified	This column displays the date and time that the individual files were saved.

46.3 The Packet Capture Screen

Use this screen to capture network traffic going through the ZyWALL's interfaces. Studying these packet captures may help you identify network problems. Click **Maintenance > Diagnostics > Packet Capture** to open the packet capture screen.

Note: New capture files overwrite existing files of the same name. Change the **File Suffix** field's setting to avoid this.

Figure 429 Maintenance > Diagnostics > Packet Capture

The following table describes the labels in this screen.

Table 221 Maintenance > Diagnostics > Packet Capture

LABEL	DESCRIPTION
Interfaces	Enabled interfaces (except for virtual interfaces) appear under Available Interfaces . Select interfaces for which to capture packets and click the right arrow button to move them to the Capture Interfaces list. Use the [Shift] and/or [Ctrl] key to select multiple objects.
IP Type	Select the protocol of traffic for which to capture packets. Select any to capture packets for all types of traffic.
Host IP	Select a host IP address object for which to capture packets. Select any to capture packets for all hosts. Select User Defined to be able to enter an IP address.
Host Port	This field is configurable when you set the IP Type to any , tcp , or udp . Specify the port number of traffic to capture.

Table 221 Maintenance > Diagnostics > Packet Capture (continued)

LABEL	DESCRIPTION
Continuously capture and overwrite old ones	Select this to have the ZyWALL keep capturing traffic and overwriting old packet capture entries when the available storage space runs out.
Save data to onboard storage only	Select this to have the ZyWALL only store packet capture entries on the ZyWALL.
Save data to USB storage	<p>Select this to have the ZyWALL store packet capture entries only on a USB storage device connected to the ZyWALL.</p> <p>Status:</p> <p>Unused - the connected USB storage device was manually unmounted by using the Remove Now button or for some reason the ZyWALL cannot mount it.</p> <p>none - no USB storage device is connected.</p> <p>available - you can have the ZyWALL use the USB storage device. The available storage capacity also displays.</p> <p>Note: The ZyWALL reserves some USG storage space as a buffer.</p>
Captured Packet Files	<p>When saving packet captures only to the ZyWALL's onboard storage, specify a maximum limit in megabytes for the total combined size of all the capture files on the ZyWALL.</p> <p>When saving packet captures to a connected USB storage device, specify a maximum limit in megabytes for each capture file.</p> <p>Note: If you have existing capture files and have not selected the Continuously capture and overwrite old ones option, you may need to set this size larger or delete existing capture files.</p> <p>The valid range is 1 to 10000. The ZyWALL stops the capture and generates the capture file when either the file reaches this size or the time period specified in the Duration field expires.</p>
Split threshold	Specify a maximum size limit in megabytes for individual packet capture files. After a packet capture file reaches this size, the ZyWALL starts another packet capture file.
Duration	Set a time limit in seconds for the capture. The ZyWALL stops the capture and generates the capture file when either this period of time has passed or the file reaches the size specified in the File Size field. 0 means there is no time limit.
File Suffix	<p>Specify text to add to the end of the file name (before the dot and filename extension) to help you identify the packet capture files. Modifying the file suffix also avoids making new capture files that overwrite existing files of the same name.</p> <p>The file name format is "interface name-file suffix.cap", for example "vlan2-packet-capture.cap".</p>

Table 221 Maintenance > Diagnostics > Packet Capture (continued)

LABEL	DESCRIPTION
Number Of Bytes To Capture (Per Packet)	Specify the maximum number of bytes to capture per packet. The ZyWALL automatically truncates packets that exceed this size. As a result, when you view the packet capture files in a packet analyzer, the actual size of the packets may be larger than the size of captured packets.
Capture	<p>Click this button to have the ZyWALL capture packets according to the settings configured in this screen.</p> <p>You can configure the ZyWALL while a packet capture is in progress although you cannot modify the packet capture settings.</p> <p>The ZyWALL's throughput or performance may be affected while a packet capture is in progress.</p> <p>After the ZyWALL finishes the capture it saves a separate capture file for each selected interface. The total number of packet capture files that you can save depends on the file sizes and the available flash storage space. Once the flash storage space is full, adding more packet captures will fail.</p>
Stop	Click this button to stop a currently running packet capture and generate a separate capture file for each selected interface.
Reset	Click this button to return the screen to its last-saved settings.

46.3.1 The Packet Capture Files Screen

Click **Maintenance > Diagnostics > Packet Capture > Files** to open the packet capture files screen. This screen lists the files of packet captures stored on the ZyWALL or a connected USB storage device. You can download the files to your computer where you can study them using a packet analyzer (also known as a network or protocol analyzer) such as Wireshark.

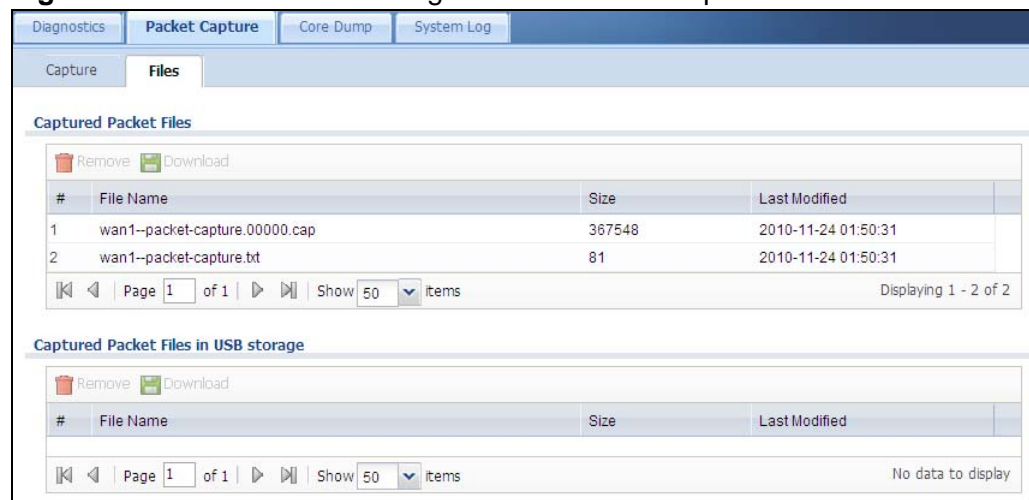
Figure 430 Maintenance > Diagnostics > Packet Capture > Files

The following table describes the labels in this screen.

Table 222 Maintenance > Diagnostics > Packet Capture > Files

LABEL	DESCRIPTION
Remove	Select files and click Remove to delete them from the ZyWALL or the connected USB storage device. Use the [Shift] and/or [Ctrl] key to select multiple files. A pop-up window asks you to confirm that you want to delete.
Download	Click a file to select it and click Download to save it to your computer.
#	This column displays the number for each packet capture file entry. The total number of packet capture files that you can save depends on the file sizes and the available flash storage space.
File Name	This column displays the label that identifies the file. The file name format is interface name-file suffix.cap.
Size	This column displays the size (in bytes) of a configuration file.
Last Modified	This column displays the date and time that the individual files were saved.

46.3.2 Example of Viewing a Packet Capture File

Here is an example of a packet capture file viewed in the Wireshark packet analyzer. Notice that the size of frame 15 on the wire is 1514 bytes while the captured size is only 1500 bytes. The ZyWALL truncated the frame because the capture screen's **Number Of Bytes To Capture (Per Packet)** field was set to 1500 bytes.

Figure 431 Packet Capture File Example

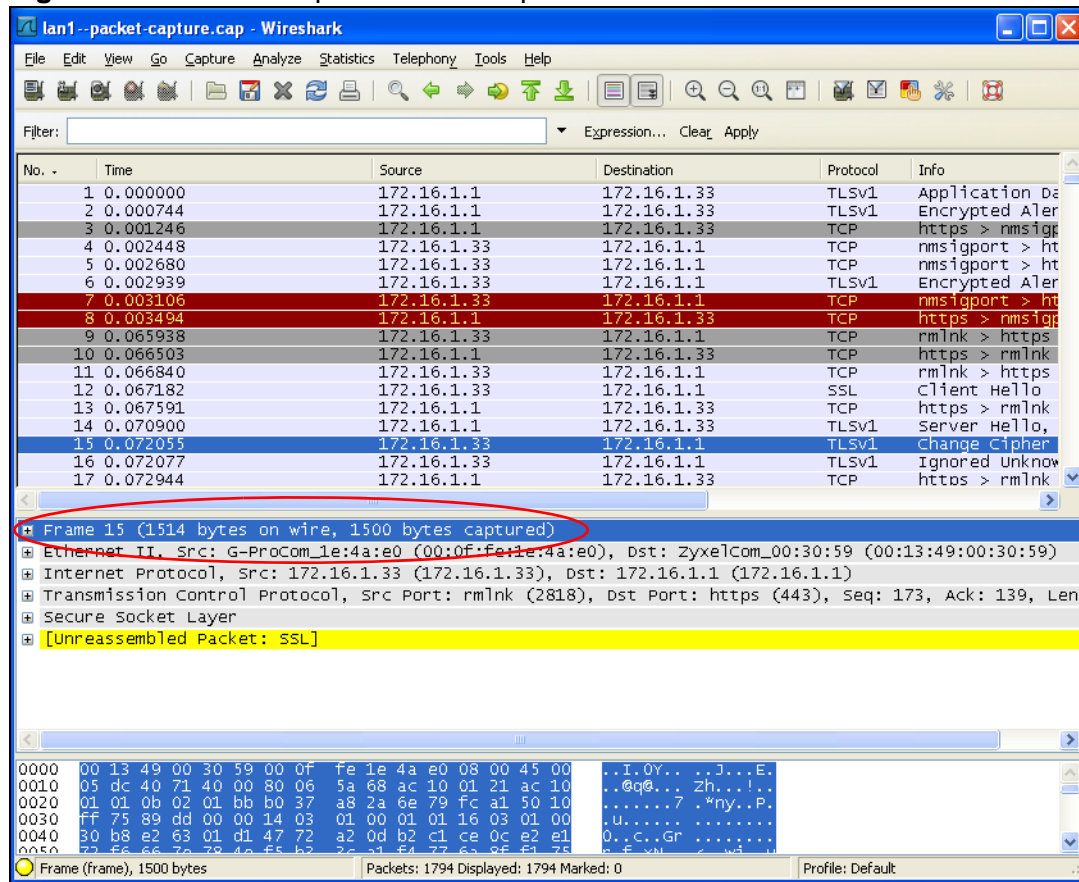

46.4 Core Dump Screen

Use the **Core Dump** screen to have the ZyWALL save a process's core dump to an attached USB storage device if the process terminates abnormally (crashes). You may need to send this file to customer support for troubleshooting.

Click **Maintenance > Diagnostics > Core Dump** to open the following screen.

Figure 432 Maintenance > Diagnostics > Core Dump

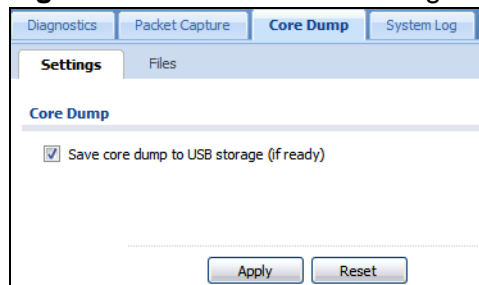

The following table describes the labels in this screen.

Table 223 Maintenance > Diagnostics > Core Dump

LABEL	DESCRIPTION
Save core dump to USB storage (if ready)	Select this to have the ZyWALL save a process's core dump to an attached USB storage device if the process terminates abnormally (crashes). If you clear this option the ZyWALL only saves
Apply	Click Apply to save the changes.
Reset	Click Reset to return the screen to its last-saved settings.

46.4.1 Core Dump Files Screen

Click **Maintenance > Diagnostics > Core Dump > Files** to open the core dump files screen. This screen lists the core dump files stored on the ZyWALL or a connected USB storage device. You may need to send these files to customer support for troubleshooting.

Figure 433 Maintenance > Diagnostics > Core Dump > Files

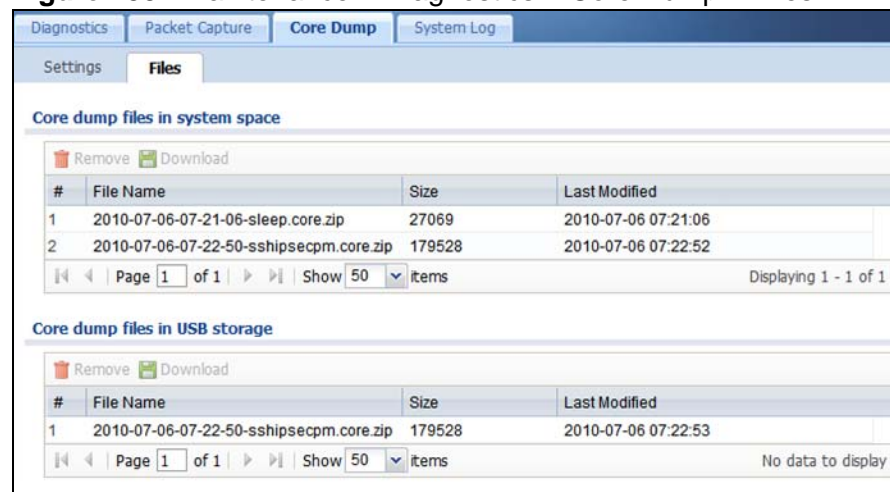

The following table describes the labels in this screen.

Table 224 Maintenance > Diagnostics > Core Dump > Files

LABEL	DESCRIPTION
Remove	Select files and click Remove to delete them from the ZyWALL. Use the [Shift] and/or [Ctrl] key to select multiple files. A pop-up window asks you to confirm that you want to delete.
Download	Click a file to select it and click Download to save it to your computer.
#	This column displays the number for each packet capture file entry. The total number of packet capture files that you can save depends on the file sizes and the available flash storage space.
File Name	This column displays the label that identifies the file.

Table 224 Maintenance > Diagnostics > Core Dump > Files (continued)

LABEL	DESCRIPTION
Size	This column displays the size (in bytes) of a file.
Last Modified	This column displays the date and time that the individual files were saved.

46.5 The System Log Screen

Click **Maintenance > Diagnostics > System Log** to open the system log files screen. This screen lists the files of system logs stored on a connected USB storage device. The files are in comma separated value (csv) format. You can download them to your computer and open them in a tool like Microsoft's Excel.

Figure 434 Maintenance > Diagnostics > System Log

#	File Name	Size	Last Modified
1	2010-07-06.log	0	2010-07-06 07:22:12

The following table describes the labels in this screen.

Table 225 Maintenance > Diagnostics > System Log

LABEL	DESCRIPTION
Remove	Select files and click Remove to delete them from the ZyWALL. Use the [Shift] and/or [Ctrl] key to select multiple files. A pop-up window asks you to confirm that you want to delete.
Download	Click a file to select it and click Download to save it to your computer.
#	This column displays the number for each file entry. The total number of files that you can save depends on the file sizes and the available storage space.
File Name	This column displays the label that identifies the file.
Size	This column displays the size (in bytes) of a file.
Last Modified	This column displays the date and time that the individual files were saved.

Packet Flow Explore

47.1 Overview

Use this to get a clear picture on how the ZyWALL determines where to forward a packet and how to change the source IP address of the packet according to your current settings. This function provides you a summary of all your routing and SNAT settings and helps troubleshoot any related problems.

47.1.1 What You Can Do in this Chapter

- Use the **Routing Status** screen (see [Section 47.2 on page 715](#)) to view the overall routing flow and each routing function's settings.
- Use the **SNAT Status** screen (see [Section 47.3 on page 719](#)) to view the overall source IP address conversion (SNAT) flow and each SNAT function's settings.

47.2 The Routing Status Screen

The **Routing Status** screen allows you to view the current routing flow and quickly link to specific routing settings. Click a function box in the **Routing Flow** section, the related routes (activated) will display in the **Routing Table** section. To access this screen, click **Maintenance > Packet Flow Explore**.

The order of the routing flow may vary depending on whether you:

- select **use policy route to override direct route** in the **CONFIGURATION > Network > Routing > Policy Route** screen.
- use policy routes to control 1-1 NAT by using the `policy control-virtual-server-rules activate` command.
- select **use policy routes to control dynamic IPSec rules** in the **CONFIGURATION > VPN > IPSec VPN > VPN Connection** screen.

Note: Once a packet matches the criteria of a routing rule, the ZyWALL takes the corresponding action and does not perform any further flow checking.

Figure 435 Maintenance > Packet Flow Explore > Routing Status (Direct Route)

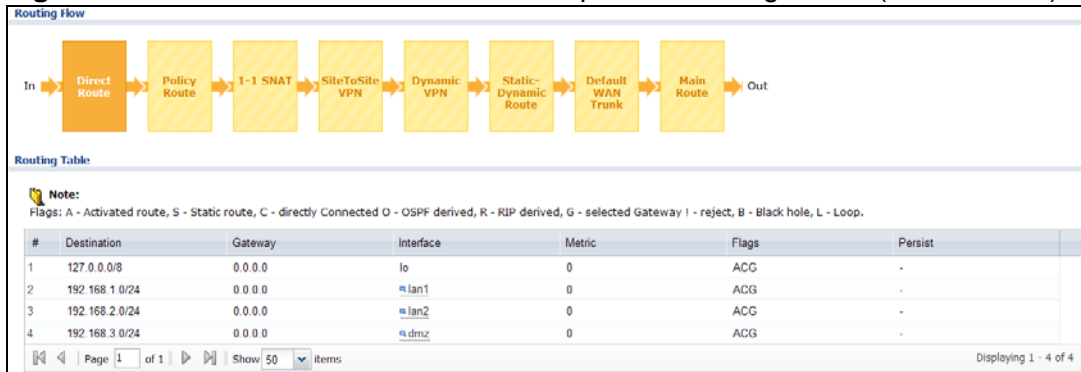

Figure 436 Maintenance > Packet Flow Explore > Routing Status (Policy Route)

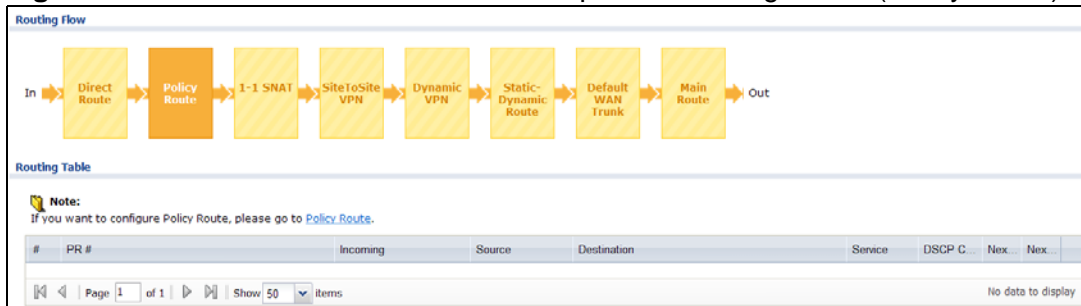

Figure 437 Maintenance > Packet Flow Explore > Routing Status (1-1 SNAT)

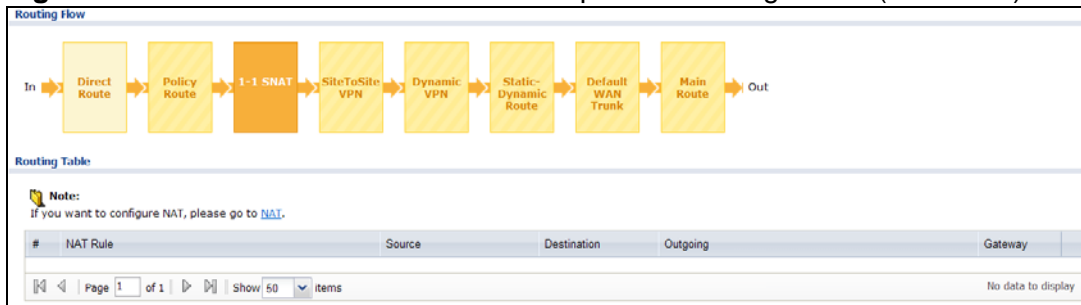

Figure 438 Maintenance > Packet Flow Explore > Routing Status (SitetoSite VPN)

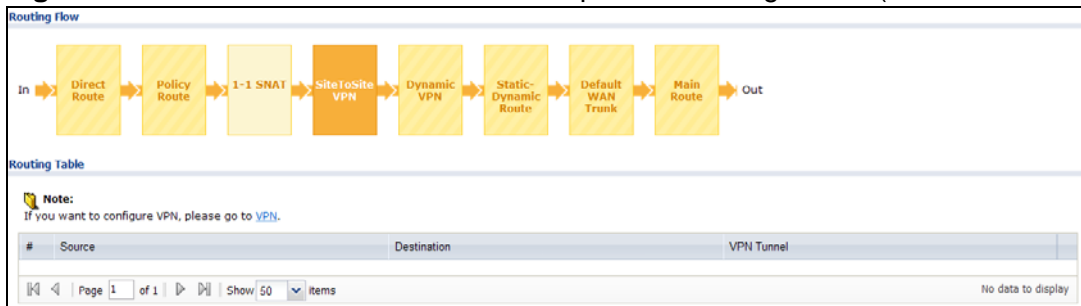

Figure 439 Maintenance > Packet Flow Explore > Routing Status (Dynamic VPN)

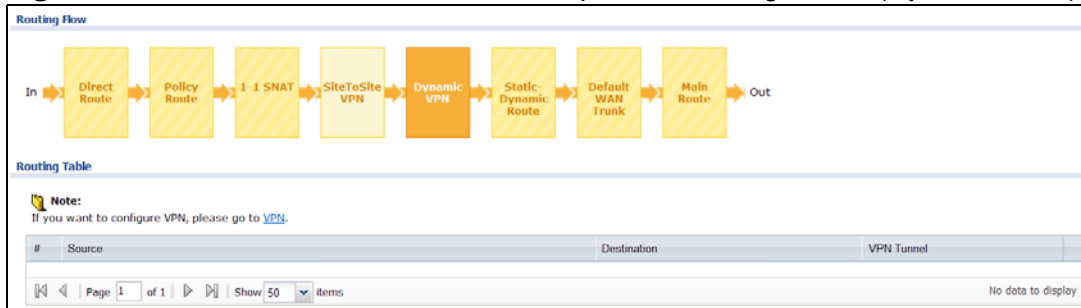

Figure 440 Maintenance > Packet Flow Explore > Routing Status (Static-Dynamic Route)

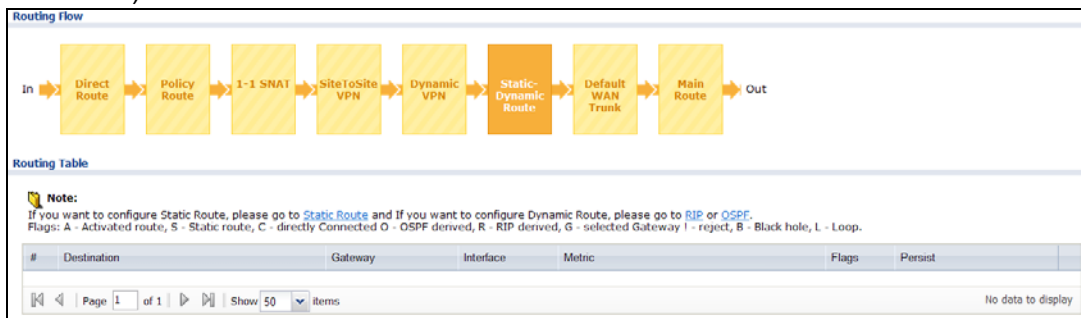

Figure 441 Maintenance > Packet Flow Explore > Routing Status (Default WAN Trunk)

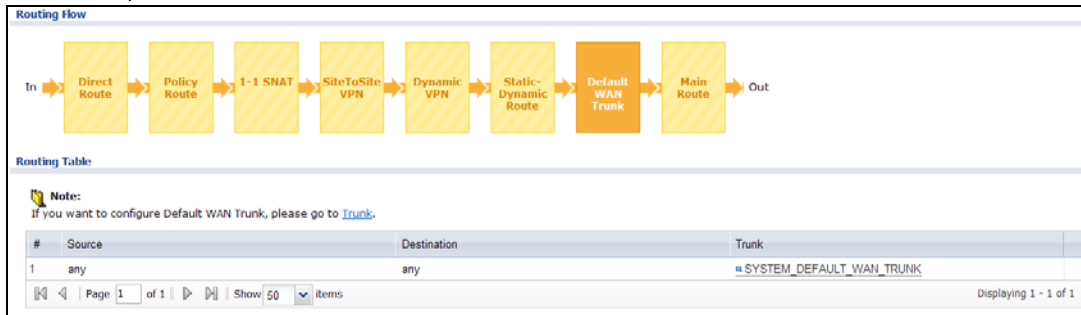
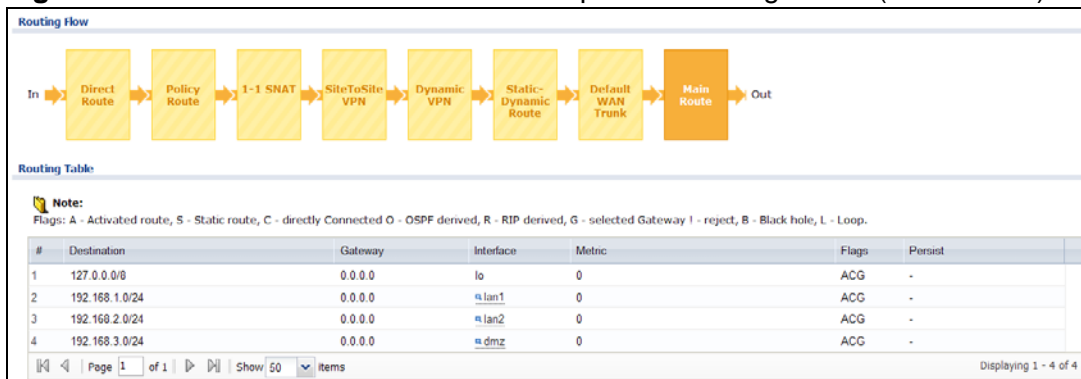

Figure 442 Maintenance > Packet Flow Explore > Routing Status (Main Route)



The following table describes the labels in this screen.

Table 226 Maintenance > Packet Flow Explore > Routing Status

LABEL	DESCRIPTION
Routing Flow	This section shows you the flow of how the ZyWALL determines where to route a packet. Click a function box to display the related settings in the Routing Table section.
Routing Table	This section shows the corresponding settings according to the function box you click in the Routing Flow section.
The following fields are available if you click Direct Route , Static-Dynamic Route , or Main Route in the Routing Flow section.	
#	This field is a sequential value, and it is not associated with any entry.
Destination	This is the destination IP address of a route.
Gateway	This is the IP address of the next-hop gateway or the interface through which the traffic is routed.
Interface	This is the name of an interface associated with the route.
Metric	This is the route's priority among the displayed routes.
Flags	This indicates additional information for the route. The possible flags are: <ul style="list-style-type: none"> • A - this route is currently activated • S - this is a static route • C - this is a direct connected route • O - this is a dynamic route learned through OSPF • R - this is a dynamic route learned through RIP • G - the route is to a gateway (router) in the same network. • ! - this is a route which forces a route lookup to fail. • B - this is a route which discards packets. • L - this is a recursive route.
Persist	This is the remaining time of a dynamically learned route. The ZyWALL removes the route after this time period is counted down to zero.
The following fields are available if you click Policy Route in the Routing Flow section.	
#	This field is a sequential value, and it is not associated with any entry.
PR #	This is the number of an activated policy route. If you have configured a schedule for the route, this screen only displays the route at the scheduled time.
Incoming	This is the interface on which the packets are received.
Source	This is the source IP address(es) from which the packets are sent.
Destination	This is the destination IP address(es) to which the packets are transmitted.
Service	This is the name of the service object. any means all services.
DSCP Code	This is the DSCP value of incoming packets to which this policy route applies. See Section 13.2 on page 300 for more information.
Next Hop Type	This is the type of the next hop to which packets are directed.

Table 226 Maintenance > Packet Flow Explore > Routing Status (continued)

LABEL	DESCRIPTION
Next Hop Info	<ul style="list-style-type: none"> This is the main route if the next hop type is Auto. This is the interface name and gateway IP address if the next hop type is Interface /GW. This is the tunnel name if the next hop type is VPN Tunnel. This is the trunk name if the next hop type is Trunk.
The following fields are available if you click 1-1 SNAT in the Routing Flow section.	
#	This field is a sequential value, and it is not associated with any entry.
NAT Rule	This is the name of an activated 1:1 or Many 1:1 NAT rule in the NAT table.
Source	This is the original source IP address(es). any means any IP address.
Destination	This is the original destination IP address(es). any means any IP address.
Outgoing	This is the name of an interface which transmits packets out of the ZyWALL.
Gateway	This is the IP address of the gateway in the same network of the outgoing interface.
The following fields are available if you click SiteToSite VPN or Dynamic VPN in the Routing Flow section.	
#	This field is a sequential value, and it is not associated with any entry.
Source	This is the IP address(es) of the local VPN network.
Destination	This is the IP address(es) for the remote VPN network.
VPN Tunnel	This is the name of the VPN tunnel.
The following fields are available if you click Default WAN Trunk in the Routing Flow section.	
#	This field is a sequential value, and it is not associated with any entry.
Source	This is the source IP address(es) from which the packets are sent. any means any IP address.
Destination	This is the destination IP address(es) to which the packets are transmitted. any means any IP address.
Trunk	This is the name of the WAN trunk through which the matched packets are transmitted.

47.3 The SNAT Status Screen

The **SNAT Status** screen allows you to view and quickly link to specific source NAT (SNAT) settings. Click a function box in the **SNAT Flow** section, the related SNAT rules (activated) will display in the **SNAT Table** section. To access this screen, click **Maintenance > Packet Flow Explore > SNAT Status**.

The order of the SNAT flow may vary depending on whether you:

- select **use default SNAT** in the **CONFIGURATION > Network > Interface > Trunk** screen.

- use policy routes to control 1-1 NAT by using the `policy control-virtual-server-rules activate` command.

Note: Once a packet matches the criteria of an SNAT rule, the ZyWALL takes the corresponding action and does not perform any further flow checking.

Figure 443 Maintenance > Packet Flow Explore > SNAT Status (Policy Route SNAT)

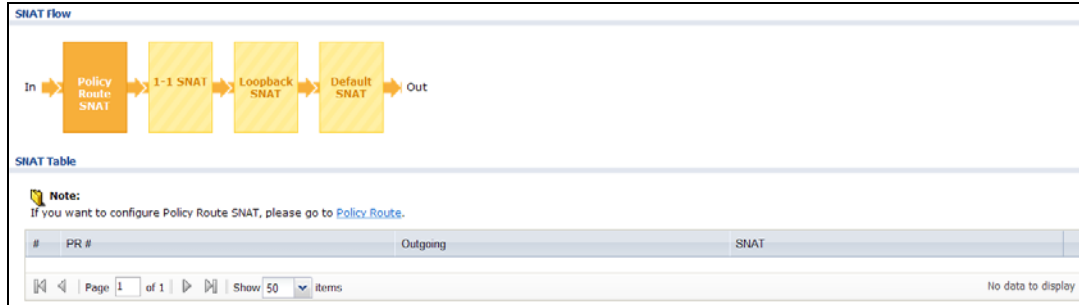

Figure 444 Maintenance > Packet Flow Explore > SNAT Status (1-1 SNAT)

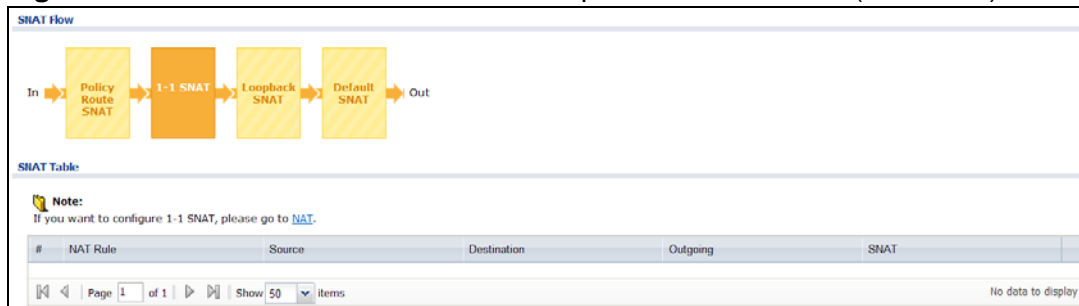

Figure 445 Maintenance > Packet Flow Explore > SNAT Status (Loopback SNAT)

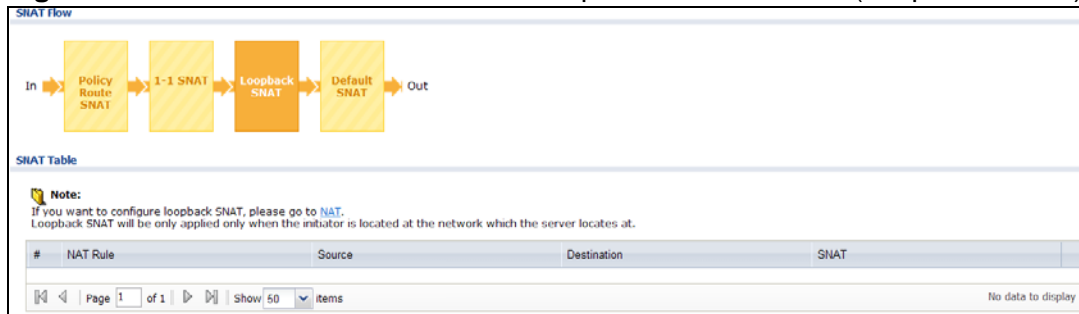
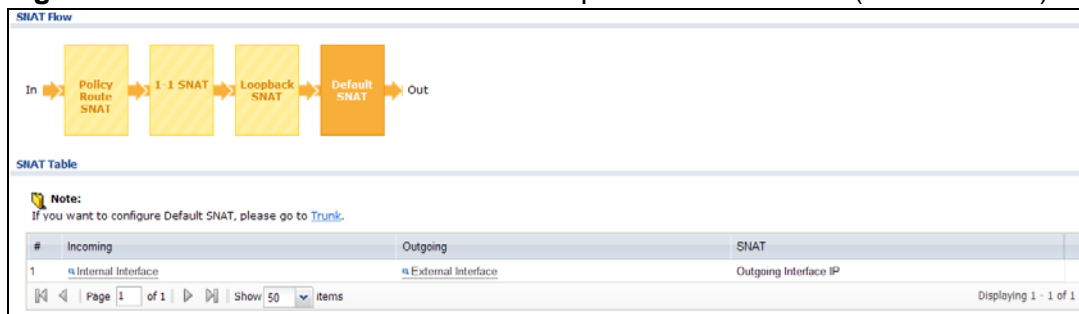

Figure 446 Maintenance > Packet Flow Explore > SNAT Status (Default SNAT)



The following table describes the labels in this screen.

Table 227 Maintenance > Packet Flow Explore > SNAT Status

LABEL	DESCRIPTION
SNAT Flow	This section shows you the flow of how the ZyWALL changes the source IP address for a packet according to the rules you have configured in the ZyWALL. Click a function box to display the related settings in the SNAT Table section.
SNAT Table	The table fields in this section vary depending on the function box you select in the SNAT Flow section.
The following fields are available if you click Policy Route SNAT in the SNAT Flow section.	
#	This field is a sequential value, and it is not associated with any entry.
PR #	This is the number of an activated policy route which uses SNAT.
Outgoing	This is the outgoing interface that the route uses to transmit packets.
SNAT	This is the source IP address(es) that the SNAT rule uses finally.
The following fields are available if you click 1-1 SNAT in the SNAT Flow section.	
#	This field is a sequential value, and it is not associated with any entry.
NAT Rule	This is the name of an activated NAT rule which uses SNAT.
Source	This is the original source IP address(es).
Destination	This is the original destination IP address(es).
Outgoing	This is the outgoing interface that the SNAT rule uses to transmit packets.
SNAT	This is the source IP address(es) that the SNAT rule uses finally.
The following fields are available if you click Loopback SNAT in the SNAT Flow section.	
#	This field is a sequential value, and it is not associated with any entry.
NAT Rule	This is the name of an activated NAT rule which uses SNAT and enables NAT loopback.
Source	This is the original source IP address(es). any means any IP address.
Destination	This is the original destination IP address(es). any means any IP address.
SNAT	This indicates which source IP address the SNAT rule uses finally. For example, Outgoing Interface IP means that the ZyWALL uses the IP address of the outgoing interface as the source IP address for the matched packets it sends out through this rule.
The following fields are available if you click Default SNAT in the SNAT Flow section.	
#	This field is a sequential value, and it is not associated with any entry.
Incoming	This indicates internal interface(s) on which the packets are received.
Outgoing	This indicates external interface(s) from which the packets are transmitted.
SNAT	This indicates which source IP address the SNAT rule uses finally. For example, Outgoing Interface IP means that the ZyWALL uses the IP address of the outgoing interface as the source IP address for the matched packets it sends out through this rule.

Reboot

48.1 Overview

Use this to restart the device (for example, if the device begins behaving erratically). See also [Section 1.5 on page 34](#) for information on different ways to start and stop the ZyWALL.

48.1.1 What You Need To Know

If you applied changes in the Web configurator, these were saved automatically and do not change when you reboot. If you made changes in the CLI, however, you have to use the `write` command to save the configuration before you reboot. Otherwise, the changes are lost when you reboot.

Reboot is different to reset; (see [Section 50.1 on page 738](#)) reset returns the device to its default configuration.

48.2 The Reboot Screen

The **Reboot** screen is part of the Web configurator so that remote users can restart the device. To access this screen, click **Maintenance > Reboot**.

Figure 447 Maintenance > Reboot



Click the **Reboot** button to restart the ZyWALL. Wait a few minutes until the login screen appears. If the login screen does not appear, type the IP address of the device in your Web browser.

You can also use the CLI command `reboot` to restart the ZyWALL.

Shutdown

49.1 Overview

Use this to shutdown the device in preparation for disconnecting the power. See also [Section 1.5 on page 34](#) for information on different ways to start and stop the ZyWALL.

Always use the Maintenance > Shutdown > Shutdown screen or the “shutdown” command before you turn off the ZyWALL or remove the power. Not doing so can cause the firmware to become corrupt.

49.1.1 What You Need To Know

Shutdown writes all cached data to the local storage and stops the system processes.

49.2 The Shutdown Screen

To access this screen, click **Maintenance > Shutdown**.

Figure 448 Maintenance > Shutdown

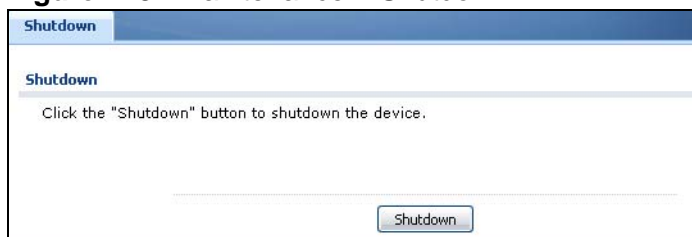

Click the **Shutdown** button to shut down the ZyWALL. Wait for the device to shut down before you manually turn off or remove the power. It does not turn off the power.

You can also use the CLI command `shutdown` to shutdown the ZyWALL.

Troubleshooting

This chapter offers some suggestions to solve problems you might encounter.

- You can also refer to the logs (see [Chapter 9 on page 207](#)). For individual log descriptions, see the User's Guide appendix [Appendix A on page 747](#).

For the order in which the ZyWALL applies its features and checks, see [Section 6.4 on page 91](#). [None of the LEDs turn on.](#)

Make sure that you have the power cord connected to the ZyWALL and plugged in to an appropriate power source. Make sure you have the ZyWALL turned on. Check all cable connections.

If the LEDs still do not turn on, you may have a hardware problem. In this case, you should contact your local vendor.

Cannot access the ZyWALL from the LAN.

- Check the cable connection between the ZyWALL and your computer or switch.
- Ping the ZyWALL from a LAN computer. Make sure your computer's Ethernet card is installed and functioning properly. Also make sure that its IP address is in the same subnet as the ZyWALL's.
- In the computer, click **Start, (All) Programs, Accessories** and then **Command Prompt**. In the **Command Prompt** window, type "ping" followed by the ZyWALL's LAN IP address (192.168.1.1 is the default) and then press [ENTER]. The ZyWALL should reply.
- If you've forgotten the ZyWALL's password, use the **RESET** button. Press the button in for about 5 seconds (or until the **PWR** LED starts to blink), then release it. It returns the ZyWALL to the factory defaults (password is 1234, LAN IP address 192.168.1.1 etc.; see your User's Guide for details).

- If you've forgotten the ZyWALL's IP address, you can use the commands through the console port to check it. Connect your computer to the **CONSOLE** port using a console cable. Your computer should have a terminal emulation communications program (such as HyperTerminal) set to VT100 terminal emulation, no parity, 8 data bits, 1 stop bit, no flow control and 115200 bps port speed.

I cannot access the Internet.

- Check the ZyWALL's connection to the Ethernet jack with Internet access. Make sure the Internet gateway device (such as a DSL modem) is working properly.
- Check the WAN interface's status in the **Dashboard**. Use the installation setup wizard again and make sure that you enter the correct settings. Use the same case as provided by your ISP.

The content filter category service is not working.

- Make sure your ZyWALL has the content filter category service registered and that the license is not expired. Purchase a new license if the license is expired.
- Make sure your ZyWALL is connected to the Internet.

I configured security settings but the ZyWALL is not applying them for certain interfaces.

Many security settings are usually applied to zones. Make sure you assign the interfaces to the appropriate zones. When you create an interface, there is no security applied on it until you assign it to a zone.

The ZyWALL is not applying the custom policy route I configured.

The ZyWALL checks the policy routes in the order that they are listed. So make sure that your custom policy route comes before any other routes that the traffic would also match.

The ZyWALL is not applying the custom firewall rule I configured.

The ZyWALL checks the firewall rules in the order that they are listed. So make sure that your custom firewall rule comes before any other rules that the traffic would also match.

I cannot enter the interface name I want.

- The format of interface names other than the Ethernet interface names is very strict. Each name consists of 2-4 letters (interface type), followed by a number (x, limited by the maximum number of each type of interface). For example, VLAN interfaces are vlan0, vlan1, vlan2, ...; and so on.

I cannot set up a PPP interface, virtual Ethernet interface or virtual VLAN interface on an Ethernet interface.

You cannot set up a PPP interface, virtual Ethernet interface or virtual VLAN interface if the underlying interface is a member of a bridge. You also cannot add an Ethernet interface or VLAN interface to a bridge if the member interface has a virtual interface or PPP interface on top of it.

My rules and settings that apply to a particular interface no longer work.

The interface's IP address may have changed. To avoid this create an IP address object based on the interface. This way the ZyWALL automatically updates every rule or setting that uses the object whenever the interface's IP address settings change. For example, if you change LAN1's IP address, the ZyWALL automatically updates the corresponding interface-based, LAN1 subnet address object.

I cannot set up a PPP interface.

You have to set up an ISP account before you create a PPPoE or PPTP interface.

The data rates through my cellular connection are no-where near the rates I expected.

The actual cellular data rate you obtain varies depending on the cellular device you use, the signal strength to the service provider's base station, and so on.

I created a cellular interface but cannot connect through it.

- Make sure you have a compatible 3G device installed or connected. See [Chapter 51 on page 741](#) for details.
- Make sure you have the cellular interface enabled.
- Make sure the cellular interface has the correct user name, password, and PIN code configured with the correct casing.
- If the ZyWALL has multiple WAN interfaces, make sure their IP addresses are on different subnets.

Hackers have accessed my WEP-encrypted wireless LAN.

WEP is extremely insecure. Its encryption can be broken by an attacker, using widely-available software. It is strongly recommended that you use a more effective security mechanism. Use the strongest security mechanism that all the wireless devices in your network support. WPA2 or WPA2-PSK is recommended.

The wireless security is not following the re-authentication timer setting I specified.

If a RADIUS server authenticates wireless stations, the re-authentication timer on the RADIUS server has priority. Change the RADIUS server's configuration if you need to use a different re-authentication timer setting.

I cannot configure a particular VLAN interface on top of an Ethernet interface even though I have it configured it on top of another Ethernet interface.

Each VLAN interface is created on top of only one Ethernet interface.

The ZyWALL is not applying an interface's configured ingress bandwidth limit.

At the time of writing, the ZyWALL does not support ingress bandwidth management.

I uploaded a custom signature file and now all of my earlier custom signatures are gone.

The name of the complete custom signature file on the ZyWALL is 'custom.rules'. If you import a file named 'custom.rules', then all custom signatures on the ZyWALL are overwritten with the new file. If this is not your intention, make sure that the files you import are not named 'custom.rules'.

The ZyWALL's performance seems slower after configuring ADP.

Depending on your network topology and traffic load, applying an anomaly profile to each and every packet direction may affect the ZyWALL's performance.

The ZyWALL routes and applies SNAT for traffic from some interfaces but not from others.

The ZyWALL automatically uses SNAT for traffic it routes from internal interfaces to external interfaces. For example LAN to WAN traffic. You must manually configure a policy route to add routing and SNAT settings for an interface with the **Interface Type** set to **General**. You can also configure a policy route to override the default routing and SNAT behavior for an interface with the **Interface Type** set to **Internal** or **External**.

The ZyWALL is not applying a policy route's port triggering settings.

You also need to create a firewall rule to allow an incoming service.

I cannot get Dynamic DNS to work.

- You must have a public WAN IP address to use Dynamic DNS.

- Make sure you recorded your DDNS account's user name, password, and domain name and have entered them properly in the ZyWALL.
- You may need to configure the DDNS entry's IP Address setting to **Auto** if the interface has a dynamic IP address or there are one or more NAT routers between the ZyWALL and the DDNS server.
- The ZyWALL may not determine the proper IP address if there is an HTTP proxy server between the ZyWALL and the DDNS server.

I cannot create a second HTTP redirect rule for an incoming interface.

You can configure up to one HTTP redirect rule for each (incoming) interface.

Make sure you have the FTP ALG enabled.

The ZyWALL keeps resetting the connection.

If an alternate gateway on the LAN has an IP address in the same subnet as the ZyWALL's LAN IP address, return traffic may not go through the ZyWALL. This is called an asymmetrical or "triangle" route. This causes the ZyWALL to reset the connection, as the connection has not been acknowledged.

You can set the ZyWALL's firewall to permit the use of asymmetrical route topology on the network (so it does not reset the connection) although this is not recommended since allowing asymmetrical routes may let traffic from the WAN go directly to the LAN without passing through the ZyWALL. A better solution is to use virtual interfaces to put the ZyWALL and the backup gateway on separate subnets. See [Asymmetrical Routes on page 381](#) and the chapter about interfaces for more information.

I cannot set up an IPSec VPN tunnel to another device.

If the IPSec tunnel does not build properly, the problem is likely a configuration error at one of the IPSec routers. Log into both ZyXEL IPSec routers and check the settings in each field methodically and slowly. Make sure both the ZyWALL and remote IPSec router have the same security settings for the VPN tunnel. It may help to display the settings for both routers side-by-side.

Here are some general suggestions. See also [Chapter 23 on page 391](#).

- The system log can often help to identify a configuration problem.
- If you enable NAT traversal, the remote IPSec device must also have NAT traversal enabled.
- The ZyWALL and remote IPSec router must use the same authentication method to establish the IKE SA.
- Both routers must use the same negotiation mode.
- Both routers must use the same encryption algorithm, authentication algorithm, and DH key group.
- When using manual keys, the ZyWALL and remote IPSec router must use the same encryption key and authentication key.
- When using pre-shared keys, the ZyWALL and the remote IPSec router must use the same pre-shared key.
- The ZyWALL's local and peer ID type and content must match the remote IPSec router's peer and local ID type and content, respectively.
- The ZyWALL and remote IPSec router must use the same active protocol.
- The ZyWALL and remote IPSec router must use the same encapsulation.
- The ZyWALL and remote IPSec router must use the same SPI.
- If the sites are/were previously connected using a leased line or ISDN router, physically disconnect these devices from the network before testing your new VPN connection. The old route may have been learnt by RIP and would take priority over the new VPN connection.
- To test whether or not a tunnel is working, ping from a computer at one site to a computer at the other.
Before doing so, ensure that both computers have Internet access (via the IPSec routers).
- It is also helpful to have a way to look at the packets that are being sent and received by the ZyWALL and remote IPSec router (for example, by using a packet sniffer).

Check the configuration for the following ZyWALL features.

- The ZyWALL does not put IPSec SAs in the routing table. You must create a policy route for each VPN tunnel. See [Chapter 13 on page 297](#).
- Make sure the To-ZyWALL firewall rules allow IPSec VPN traffic to the ZyWALL. IKE uses UDP port 500, AH uses IP protocol 51, and ESP uses IP protocol 50.
- The ZyWALL supports UDP port 500 and UDP port 4500 for NAT traversal. If you enable this, make sure the To-ZyWALL firewall rules allow UDP port 4500 too.
- Make sure regular firewall rules allow traffic between the VPN tunnel and the rest of the network. Regular firewall rules check packets the ZyWALL sends before the ZyWALL encrypts them and check packets the ZyWALL receives after the ZyWALL decrypts them. This depends on the zone to which you assign the VPN tunnel and the zone from which and to which traffic may be routed.

- If you set up a VPN tunnel across the Internet, make sure your ISP supports AH or ESP (whichever you are using).
- If you have the ZyWALL and remote IPsec router use certificates to authenticate each other, You must set up the certificates for the ZyWALL and remote IPsec router first and make sure they trust each other's certificates. If the ZyWALL's certificate is self-signed, import it into the remote IPsec router. If it is signed by a CA, make sure the remote IPsec router trusts that CA. The ZyWALL uses one of its **Trusted Certificates** to authenticate the remote IPsec router's certificate. The trusted certificate can be the remote IPsec router's self-signed certificate or that of a trusted CA that signed the remote IPsec router's certificate.
- Multiple SAs connecting through a secure gateway must have the same negotiation mode.

The VPN connection is up but VPN traffic cannot be transmitted through the VPN tunnel.

If you have the **Configuration > VPN > IPsec VPN > VPN Connection** screen's **Use Policy Route to control dynamic IPsec rules option** enabled, check the routing policies to see if they are sending traffic elsewhere instead of through the VPN tunnels.

I uploaded a logo to show in the SSL VPN user screens but it does not display properly.

The logo graphic must be GIF, JPG, or PNG format. The graphic should use a resolution of 127 x 57 pixels to avoid distortion when displayed. The ZyWALL automatically resizes a graphic of a different resolution to 127 x 57 pixels. The file size must be 100 kilobytes or less. Transparent background is recommended.

I logged into the SSL VPN but cannot see some of the resource links.

Available resource links vary depending on the SSL application object's configuration.

I changed the LAN IP address and can no longer access the Internet.

The ZyWALL automatically updates address objects based on an interface's IP address, subnet, or gateway if the interface's IP address settings change. However, you need to manually edit any address objects for your LAN that are not based on the interface.

I cannot get the RADIUS server to authenticate the ZyWALL's default admin account.

The default **admin** account is always authenticated locally, regardless of the authentication method setting. (See [Chapter 37 on page 573](#) for more information about authentication methods.)

The ZyWALL fails to authentication the ext-user user accounts I configured.

An external server such as AD, LDAP or RADIUS must authenticate the ext-user accounts. If the ZyWALL tries to use the local database to authenticate an **ext-user**, the authentication attempt will always fail. (This is related to AAA servers and authentication methods, which are discussed in [Chapter 37 on page 573](#) and [Chapter 38 on page 583](#), respectively.)

I cannot add the admin users to a user group with access users.

You cannot put access users and admin users in the same user group.

I cannot add the default admin account to a user group.

You cannot put the default **admin** account into any user group.

The schedule I configured is not being applied at the configured times.

Make sure the ZyWALL's current date and time are correct.

I cannot get a certificate to import into the ZyWALL.

- 1 For **My Certificates**, you can import a certificate that matches a corresponding certification request that was generated by the ZyWALL. You can also import a certificate in PKCS#12 format, including the certificate's public and private keys.
- 2 You must remove any spaces from the certificate's filename before you can import the certificate.
- 3 Any certificate that you want to import has to be in one of these file formats:
 - Binary X.509: This is an ITU-T recommendation that defines the formats for X.509 certificates.
 - PEM (Base-64) encoded X.509: This Privacy Enhanced Mail format uses lowercase letters, uppercase letters and numerals to convert a binary X.509 certificate into a printable form.
 - Binary PKCS#7: This is a standard that defines the general syntax for data (including digital signatures) that may be encrypted. A PKCS #7 file is used to transfer a public key certificate. The private key is not included. The ZyWALL currently allows the importation of a PKS#7 file that contains a single certificate.
 - PEM (Base-64) encoded PKCS#7: This Privacy Enhanced Mail (PEM) format uses lowercase letters, uppercase letters and numerals to convert a binary PKCS#7 certificate into a printable form.
 - Binary PKCS#12: This is a format for transferring public key and private key certificates. The private key in a PKCS #12 file is within a password-encrypted envelope. The file's password is not connected to your certificate's public or private passwords. Exporting a PKCS #12 file creates this and you must provide it to decrypt the contents when you import the file into the ZyWALL.

Note: Be careful not to convert a binary file to text during the transfer process. It is easy for this to occur since many programs use text files by default.

I cannot access the ZyWALL from a computer connected to the Internet.

Check the service control rules and to-ZyWALL firewall rules.

I uploaded a logo to display on the upper left corner of the Web Configurator login screen and access page but it does not display properly.

Make sure the logo file is a GIF, JPG, or PNG of 100 kilobytes or less.

I uploaded a logo to use as the screen or window background but it does not display properly.

Make sure the logo file is a GIF, JPG, or PNG of 100 kilobytes or less.

The ZyWALL's traffic throughput rate decreased after I started collecting traffic statistics.

Data collection may decrease the ZyWALL's traffic throughput rate.

I can only see newer logs. Older logs are missing.

When a log reaches the maximum number of log messages, new log messages automatically overwrite existing log messages, starting with the oldest existing log message first.

The commands in my configuration file or shell script are not working properly.

- In a configuration file or shell script, use “#” or “!” as the first character of a command line to have the ZyWALL treat the line as a comment.
- Your configuration files or shell scripts can use “exit” or a command line consisting of a single “!” to have the ZyWALL exit sub command mode.
- Include `write` commands in your scripts. Otherwise the changes will be lost when the ZyWALL restarts. You could use multiple `write` commands in a long script.

Note: “exit” or “!” must follow sub commands if it is to make the ZyWALL exit sub command mode.

See [Chapter 45 on page 693](#) for more on configuration files and shell scripts.

I cannot get the firmware uploaded using the commands.

The Web Configurator is the recommended method for uploading firmware. You only need to use the command line interface if you need to recover the firmware.

See the CLI Reference Guide for how to determine if you need to recover the firmware and how to recover it.

My packet capture captured less than I wanted or failed.

The packet capture screen's **File Size** sets a maximum size limit for the total combined size of all the capture files on the ZyWALL, including any existing capture files and any new capture files you generate. If you have existing capture files you may need to set this size larger or delete existing capture files.

The ZyWALL stops the capture and generates the capture file when either the capture files reach the **File Size** or the time period specified in the **Duration** field expires.

My earlier packet capture files are missing.

New capture files overwrite existing files of the same name. Change the **File Suffix** field's setting to avoid this.

50.1 Resetting the ZyWALL

If you cannot access the ZyWALL by any method, try restarting it by turning the power off and then on again. If you still cannot access the ZyWALL by any method or you forget the administrator password(s), you can reset the ZyWALL to its factory-default settings. Any configuration files or shell scripts that you saved on the ZyWALL should still be available afterwards.

Use the following procedure to reset the ZyWALL to its factory-default settings. This overwrites the settings in the startup-config.conf file with the settings in the system-default.conf file.

Note: This procedure removes the current configuration.

If you want to reboot the device without changing the current configuration, see [Chapter 48 on page 723](#).

- 1 Make sure the **SYS** LED is on and not blinking.

- 2 Press the **RESET** button and hold it until the **SYS** LED begins to blink. (This usually takes about five seconds.)
- 3 Release the **RESET** button, and wait for the ZyWALL to restart.

You should be able to access the ZyWALL using the default settings.

50.2 Getting More Troubleshooting Help

Search for support information for your model at www.zyxel.com for more troubleshooting suggestions.

Product Specifications

The following specifications are subject to change without notice. See [Chapter 2 on page 37](#) for a general overview of key features.

This table provides basic device specifications.

Table 228 Default Login Information

ATTRIBUTE	SPECIFICATION
Default IP Address (P2, P3)	192.168.1.1
Default Subnet Mask (P2, P3)	255.255.255.0 (24 bits)
Default Password	1234

This table provides hardware specifications.

Table 229 Hardware Specifications

FEATURE	SPECIFICATION
Ethernet Interfaces	Number of Ethernet interfaces: 4
Management interface	RS-232, DB9F connector
USB Slots	1, 2.0 plug and play
Compatible USB Cards (3G)	See www.zyxel.com for the supported 3G cards.
Power Requirements	12V DC
Operating Environment	Temperature: 0 C to 40 C Humidity: 20% to 95% (non-condensing)
Storage Environment	Temperature: -30 C to 60 C Humidity: 20% to 95% (non-condensing)
MTBF	Mean Time Between Failures: 323,823 hours
Wall-mounting	The ZyWALL has wall-mounting holes on the bottom panel. The centers of the holes are located 156 mm apart.

It is recommended that you do NOT wall-mount the ZyWALL. A wall-mounting kit is not included.

This table gives details about the ZyWALL's features.

Table 230 ZyWALL Feature Specifications

FEATURE	
# of MAC	5 (USG 20) 6 (USG 20W)
Flash Size	128
DRAM Size	256
INTERFACE	
VLAN	8
Virtual (alias)	4 per interface
PPP (system default)	1
PPP (user created)	2
Bridge	2
ROUTING	
Static Routes	64
Policy Routes	100
Sessions	6000
ARP Table Size	1024
MAC Table Size (For Bridge Mode only)	8K
NAT	
MAX. Virtual Server Number	128
Trigger Port Rules	up to 8 per PR rule
HTTP Redirect	up to interface limit
New Session Rate (sessions per second)	1000
FIREWALL	
Firewall ACL Rules	500
Maximum Session Limit per Host Rules	500
USER PROFILES	
Maximum Local Users	64
Maximum Admin Users	5
Maximum User Groups	16
Maximum Users in One User Group	64
OBJECTS	
Address Objects	100
Address Groups	25
Maximum address object in one group	64
Service Objects	200

Table 230 ZyWALL Feature Specifications (continued)

FEATURE	
Service Groups	50
Maximum service object in one group	64
Schedule Objects	16
ISP Account	4
Maximum Number of LDAP Groups	2
Maximum Number of LDAP Servers for Each LDAP Group	2
Maximum Number of RADIUS Groups	2
Maximum Number of RADIUS Servers for Each RADIUS Group	2
Maximum AD server for each AD group	2
Maximum AD group number	4
Number of Zones (system default)	7
Maximum Number of Zones (user created)	8
Number of Trunks (system default)	1
Maximum Number of Trunks (user created)	2
IPSEC VPN	
Maximum Number of IPSec VPN Tunnels	5
CERTIFICATES	
Certificate Buffer Size	64 K
BUILT-IN SERVICES	
A record	32
NS record	4
MX record	4
Maximum Number of Service Control Entries	8 per service
Maximum DHCP Host Pool	64
Maximum Number of DDNS Profiles	5
DHCP Relay	2 per interface
CENTRALIZED LOG	
Log Entries	512
Debug Log Entries	1024
Admin E-mail Addresses	2
Syslog Servers	4
ADP	
Maximum Number of ADP Profiles	8
Maximum Number of ADP Rules	16
Maximum Block Host Number	1000
Maximum Block Period	3600

Table 230 ZyWALL Feature Specifications (continued)

FEATURE	
CONTENT FILTER	
Maximum Number of Content Filter Policies	8
Maximum Number of Content Filter Profiles	8
Maximum Number of Forbidden Domain Entries	64 per profile
Maximum Number of Trusted Domain Entries	64 per profile
Maximum Number of Keywords that Can Be Blocked	64 per profile
Local Cache Size	512
Maximum Number of Concurrent Connection Requests	64
ANTI-SPAM	
Maximum Number of Concurrent Mail Sessions	50
Maximum Number of Anti-Spam Rules	16
Maximum Number of White List Entries	48
Maximum Number of Black List Entries	48
Maximum Number of DNSBLs	5
Maximum Number of Anti-Spam Statistics	100
Maximum Anti-Spam Statistics Ranking	10
SSL VPN	
Maximum SSL VPN Connections	1
OTHERS	
Maximum Number of OSPF Areas	16

The following table, which is not exhaustive, lists standards referenced by ZyWALL features.

Table 231 Standards Referenced by Features

FEATURE	STANDARDS REFERENCED
Interface-Bridge	A subset of the ANSI/IEEE 802.1d standard
Interface	RFCs 2131, 2132, 1541
Interface-PPP	RFCs 1144, 1321, 1332, 1334, 1661, 1662, 2472
Interface-PPTP	RFCs 2637, 3078
Interface-PPPOE	RFC 2516
Interface-VLAN	IEEE 802.1Q
Dynamic Route, Show IP route	RFCs 1058, 2082, 2453, 2328, 3101, 3137
Telnet server	RFCs 1408, 1572
SSH server	RFCs 4250, 4251, 4252, 4253, 4254

Table 231 Standards Referenced by Features (continued)

FEATURE	STANDARDS REFERENCED
Built-in service, DNS server	RFCs 1034, 1035, 1123, 1183, 1535, 1536, 1706, 1712, 1750, 1876, 1982, 1995, 1996, 2136, 2163, 2181, 2230, 2308, 2535, 2536, 2537, 2538, 2539, 2671, 2672, 2673, 2782, 3007, 3090
Built-in service, DHCP server	RFCs 1542, 2131, 2132, 2485, 2489
Built-in service, HTTP server	RFCs 1945, 2616, 2965, 2732, 2295
Built-in service, SNMP agent	RFCs 1067, 1213, 2576, 2578, 2579, 2580, 2741, 2667, 2981, 3371
Login, LDAP support.	RFCs 2251, 2252, 2253, 2254, 2255, 2256, 2589, 2829, 2830
Used by Apache	RFCs 2437, 2246, 2560, 2712, 3268, 3280, 3820, 4132
Built-in service, FTP server	RFCs 959, 2228, 2389, 2865, 2138, 2640
Used by Centralized log	RFC 3164
Login, new PAM module	OSF-RFC 86.0, 1321
Built-in service, NTP client	RFCs 958, 1059, 1119, 1305
Used by SSH service	RFCs 4250, 4251, 4252, 4253, 4254
Used by Time service	RFCs 3339
Used by Telnet service	RFCs 318, 854, 1413
Used by SIP ALG	RFCs 3261, 3264
DHCP relay	RFC 1541
ZySH	W3C XML standard
ARP	RFC 826
IP/IPv4	RFC 791
TCP	RFC 793

51.1 Power Adaptor Specifications

Table 232 North American Plug Standards

AC POWER ADAPTOR MODEL	PSA18R-120P (ZA)-R
INPUT POWER	100-240VAC, 50/60HZ, 0.5A
OUTPUT POWER	12VDC, 1.5A
POWER CONSUMPTION	20 W MAX.
SAFETY STANDARDS	UL, CUL (UL 60950-1 FIRST EDITION CSA C22.2 NO. 60950-1-03 1ST.)

Table 233 European Plug Standards

AC POWER ADAPTOR MODEL	PSA18R-120P (ZE)-R
INPUT POWER	100-240VAC, 50/60HZ, 0.5A
OUTPUT POWER	12VDC, 1.5A
POWER CONSUMPTION	20 W MAX.
SAFETY STANDARDS	TUV, CE (EN 60950-1)

Table 234 United Kingdom Plug Standards

AC POWER ADAPTOR MODEL	PSA18R-120P (ZK)-R
INPUT POWER	100-240VAC, 50/60HZ, 0.5A
OUTPUT POWER	12VDC, 3.5A
POWER CONSUMPTION	20 W MAX.
SAFETY STANDARDS	TUV (BS EN 60950-1)

Table 235 Australia And New Zealand Plug Standards

AC POWER ADAPTOR MODEL	PSA18R-120P (ZS)-R
INPUT POWER	100-240VAC, 50/60HZ, 0.5A
OUTPUT POWER	12VDC, 3.5A
POWER CONSUMPTION	20 W MAX.
SAFETY STANDARDS	AS/NZ60950

Table 236 Japan Plug Standards

AC POWER ADAPTOR MODEL	PSA18R-120P (ZA)-R
INPUT POWER	100-240VAC, 50/60HZ, 0.5A
OUTPUT POWER	12VDC, 3.5A
POWER CONSUMPTION	20 W MAX.
SAFETY STANDARDS	JET

Table 237 China Plug Standards

AC POWER ADAPTOR MODEL	PSA18R-120P (ZA)-R
INPUT POWER	100-240VAC, 50/60HZ, 0.5A
OUTPUT POWER	12VDC, 3.5A
POWER CONSUMPTION	20 W MAX.
SAFETY STANDARDS	CCC

Log Descriptions

This appendix provides descriptions of example log messages for the ZLD-based ZyWALLs. The logs do not all apply to all of the ZLD-based ZyWALLs. You will not necessarily see all of these logs in your device.

Table 238 Content Filter Logs

LOG MESSAGE	DESCRIPTION
Content filter has been enabled	An administrator turned the content filter on.
Content filter has been disabled	An administrator turned the content filter off.
Content filter report has been disabled	The content filter report was turned off.
Content filter has been enabled	The content filter was report turned on.
Content filter has been changed zsb port to 80	The content filtering checking for unsafe web sites has been changed to use port 80 due to a configuration change.
Content filter has been changed zsb port to 23	The content filtering checking for unsafe web sites has been changed to use port 23 due to a configuration change.

Table 239 Forward Web Site Logs

LOG MESSAGE	DESCRIPTION
%s: Trusted Web site	The device allowed access to a web site in a trusted domain. %s: website host
%s	The device allowed access to a web site. The content filtering service is registered and activated or the service is not activated in a profile, this is a web site that is not blocked according to a profile and the default policy is not set to block. %s: website host
%s: Service is not registered	The device allowed access to a web site. The content filtering service is unregistered and the default policy is not set to block. %s: website host

Table 240 Blocked Web Site Logs

LOG MESSAGE	DESCRIPTION
%s : %s	The rating server responded that the web site is in a specified category and access was blocked according to a content filter profile. 1st %s: website host 2nd %s: website category
%s: Unrated	The rating server responded that the web site cannot be categorized and access was blocked according to a content filter profile. %s: website host
%s: Service is unavailable	Content filter rating service is temporarily unavailable and access to the web site was blocked due to: 1. Can't resolve rating server IP (No DNS) 2. Invalid service license 4. Rating service is restarting 5. Can't connect to rating server 6. Query failed 7. Query timeout 8. Too many queries 9. Unknown reason %s: website host
%s: %s(cache hit)	The web site's category exists in the device's local cache and access was blocked according to a content filter profile. 1st %s: website host 2nd %s: website category
%s: Not in trusted web list	The web site is not a trusted host/domain, and the device blocks all traffic except for trusted web sites. %s: website host
%s: Contains ActiveX	The web site contains ActiveX and access was blocked according to a profile. %s: website host
%s: Contains Java applet	The web site contains Java applet and access was blocked according to a profile. %s: website host
%s: Contains cookie	The web site contains a cookie and access was blocked according to a profile. %s: website host

Table 240 Blocked Web Site Logs (continued)

LOG MESSAGE	DESCRIPTION
%s: Proxy mode is detected	The system detected a proxy connection and blocked access according to a profile. %s: website host
%s: Forbidden Web site	The web site is in forbidden web site list. %s: website host
%s: Keyword blocking	The web content matched a user defined keyword. %s: website host
%s: Blocking by default policy	No content filter policy is applied and access was blocked since the default action is block. %s: website host

Table 241 Anti-Spam Logs

LOG MESSAGE	DESCRIPTION
Anti-Spam has been activated.	The anti-spam feature has been turned on.
Anti-Spam has been deactivated.	The anti-spam feature has been turned off.
Anti-Spam policy %d has been modified.	The anti-spam policy with the specified index number (%d) has been changed.
Anti-Spam policy %d has been inserted.	The anti-spam policy with the specified index number (%d) has been added into the list.
Anti-Spam policy %d has been appended.	The anti-spam policy with the specified index number (%d) has been added to the end of the list.
Anti-Spam policy %d has been deleted.	The anti-spam policy with the specified index number (%d) has been removed.
Anti-Spam policy %d has been moved to %d.	The anti-spam policy with the specified index number (first %d) was moved to the specified index number (second %d).
White List checking has been activated.	The anti-spam white list has been turned on.
White List checking has been deactivated.	The anti-spam white list has been turned off.
White List rule %d has been added.	The anti-spam white list rule with the specified index number (%d) has been added.
White List rule %d has been modified.	The anti-spam white list rule with the specified index number (%d) has been changed.
White List rule %d has been deleted.	The anti-spam white list rule with the specified index number (%d) has been removed.
White List rule %d has been activated.	The anti-spam white list rule with the specified index number (%d) has been turned on.
White List rule %d has been deactivated.	The anti-spam white list rule with the specified index number (%d) has been turned off.

Table 241 Anti-Spam Logs (continued)

LOG MESSAGE	DESCRIPTION
Black List checking has been activated.	The anti-spam black list has been turned on.
Black List checking has been deactivated.	The anti-spam black list has been turned off.
Black List rule %d has been added.	The anti-spam black list rule with the specified index number (%d) has been added.
Black List rule %d has been modified.	The anti-spam black list rule with the specified index number (%d) has been changed.
Black List rule %d has been deleted.	The anti-spam black list rule with the specified index number (%d) has been removed.
Black List rule %d has been activated.	The anti-spam black list rule with the specified index number (%d) has been turned on.
Black List rule %d has been deactivated.	The anti-spam black list rule with the specified index number (%d) has been turned off.
DNSBL checking has been activated.	anti-spam DNSBL (DNS Black List) server checking has been turned on.
DNSBL checking has been deactivated.	The anti-spam DNSBL checking has been turned off.
DNSBL domain %s has been added.	The specified DNSBL domain name (%s) has been added.
DNSBL domain %s has been modified to %s.	The specified DNSBL domain name (first %s) has been changed to the second %s.
DNSBL domain %s has been deleted.	The specified DNSBL domain name (%s) has been removed.
DNSBL domain %s has been activated.	The specified DNSBL domain name (%s) has been turned on.
DNSBL domain %s has been deactivated.	The specified DNSBL domain name (%s) has been turned off.
Match White List: %d. From:%s Subject:%s	An e-mail matched the specified white list rule (%d). The e-mail's From (first %s) and Subject (second %s) header values are listed.
Match Black List: %d. From:%s Subject:%s	An e-mail matched the specified black list rule (%d). The e-mail's From (first %s) and Subject (second %s) header values are listed.
IP %s in DNSBL %s. From:%s Subject:%s	The listed IP address (the first %s) was listed in the specified DNSBL (second %s). The e-mail's From (third %s) and Subject (fourth %s) header values are listed.
DNSBL timeout. Mail From:%s Subject:%s	Queries to the DSNBL timed out. The e-mail's From (first %s) and Subject (second %s) header values are listed.
Mail sessions have reached the maximum threshold of %d.	The number of concurrent e-mail sessions has exceeded the maximum number of concurrent e-mail sessions that the anti-spam feature can handle (%d).

Table 242 SSL VPN Logs

LOG MESSAGE	DESCRIPTION
%s %s from %s has logged in SSLVPN	A user has logged into SSL VPN. The first %s is the type of user account. The second %s is the user's user name. The third %s is the name of the service the user is using (HTTP or HTTPS).
%s %s from %s has logged out SSLVPN	A user has logged out of SSL VPN. The first %s is the type of user account. The second %s is the user's user name. The third %s is the name of the service the user is using (HTTP or HTTPS). The Note field's %s is the user name.
%s accesses web application %s	The specified user (first %s) has logged into the specified SSL VPN web application (second %s).
SSL tunnel is established	An SSL tunnel has been built. The source is the login IP address. The destination is the IP address given to the SSL user.
SSL tunnel is disconnected	An SSL tunnel has been disconnected. The source is the login IP address. The destination is the IP address given to the SSL user.
The %s address-object is invalid IP in SSL Policy %s.	The listed address object (first %s) is not an allowed IP for the listed SSL policy (second %s).
The %s address-object does not has assignable IP in SSL Policy %s.	There are no more assignable IP addresses in the listed address object (first %s). The address object is used by the listed SSL policy (second %s).
The %s address-object is wrong type for '1st-dns' in SSL Policy %s.	The listed address object (first %s) is not the right kind for the first DNS server specified in the listed SSL VPN policy (second %s).
The %s address-object is wrong type for '2nd-dns' in SSL Policy %s.	The listed address object (first %s) is not the right kind for the second DNS server specified in the listed SSL VPN policy (second %s).
The %s address-object is wrong type for '1st-wins' in SSL Policy %s.	The listed address object (first %s) is not the right kind for the first WINS server specified in the listed SSL VPN policy (second %s).
The %s address-object is wrong type for '2nd-wins' in SSL Policy %s.	The listed address object (first %s) is not the right kind for the second WINS server specified in the listed SSL VPN policy (second %s).

Table 242 SSL VPN Logs (continued)

LOG MESSAGE	DESCRIPTION
The %s address-object is wrong type for 'network' in SSL Policy %s.	The listed address object (first %s) is not the right kind to be specified as a network in the listed SSL VPN policy (second %s).
The SSL VPN policy %s has been changed 'ip-pool' value.	The IP pool setting has been modified in the specified SSL VPN policy (%s).
The SSL VPN policy %s has been changed '1st-dns' value.	The first DNS server setting has been modified in the specified SSL VPN policy (%s).
The SSL VPN policy %s has been changed '2nd-dns' value.	The second DNS server setting has been modified in the specified SSL VPN policy (%s).
The SSL VPN policy %s has been changed '1st-wins' value.	The first WINS server setting has been modified in the specified SSL VPN policy (%s).
The SSL VPN policy %s has been changed 'network' value.	The list of networks has been modified in the specified SSL VPN policy (%s).
The SSL VPN policy %s has been changed '2nd-wins' value.	The second WINS server setting has been modified in the specified SSL VPN policy (%s).
The IP pool is same subnet with %s in SSL VPN policy %s. So %s will not be injected to client side.	The IP pool is in the same subnet as the specified address object (first %s) in the listed SSL VPN policy (second %s), so the listed address (third %s) will not be given to an SSL VPN client.
The %s is same subnet with IP pool in SSL VPN policy %s. So %s will not be injected to client side.	The specified address object (first %s) is in the same subnet as the IP pool in the listed SSL VPN policy (second %s), so the listed address (third %s) will not be given to an SSL VPN client.
The SSL VPN policy %s does not configure users or user groups.	There are no users or user groups configured for the listed SSL VPN policy (%s).
SSL VPN policy rule %s has been inserted.	The listed SSL VPN policy (%s) has been inserted in the list of SSL VPN policy rules.
SSL VPN policy rule %s has been appended.	The listed SSL VPN policy (%s) has been added to the end of the list.
SSL VPN policy rule %s has been modified.	The configuration of the listed SSL VPN policy (%s) has been changed.
SSL VPN policy rule %s has been moved to %d.	The listed SSL VPN policy (%s) has been moved to the listed position (%d) in the list of SSL VPN policies.
SSL VPN policy rule %s has been deleted.	The listed SSL VPN policy has been removed.

Table 242 SSL VPN Logs (continued)

LOG MESSAGE	DESCRIPTION
%s %s from %s has been logged out SSLVPN (re-auth timeout)	The specified user was signed out by the device due to a re-authentication timeout. The first %s is the type of user account. The second %s is the user's user name. The third %s is the name of the service the user is using (HTTP or HTTPS).
%s %s from %s has been logged out SSLVPN (lease timeout)	The specified user was signed out by the device due to a lease timeout. The first %s is the type of user account. The second %s is the user's user name. The third %s is the name of the service the user is using (HTTP or HTTPS).
%s %s from %s has been logged out SSLVPN (idle timeout)	The specified user was signed out by the device due to an idle timeout. The first %s is the type of user account. The second %s is the user's user name. The third %s is the name of the service the user is using (HTTP or HTTPS).
Failed login attempt to SSLVPN from %s (login on a lockout address)	An SSL VPN login attempt from the listed user (%s) was blocked due to too many failed login attempts.
Failed login attempt to SSLVPN from %s (reach the max. number of user)	The listed user (%s) failed to log into SSL VPN because the maximum number of users were already logged in.
Failed login attempt to SSLVPN from %s (reach the max. number of simultaneous logon)	The listed user (%s) failed to log into SSL VPN because the maximum number of simultaneous logons was already reached.
Failed login attempt to SSLVPN from %s (incorrect password or inexistent username)	The listed user (%s) failed to log into SSL VPN because of entering an incorrect password or a user name that does not exist.
%s: Failed to receive messages from uam daemon.	Messages were not received from the UAM daemon.

The ZySH logs deal with internal system errors.

Table 243 ZySH Logs

LOG MESSAGE	DESCRIPTION
Invalid message queue. Maybe someone starts another zysh daemon.	
ZySH daemon is instructed to reset by %d	1st:pid num
System integrity error!	
Group OPS	
cannot close property group	
cannot close group	
%s: cannot get size of group	1st:zysh group name
%s: cannot specify properties for entry %s	1st:zysh group name, 2st:zysh entry name
%s: cannot join group %s, loop detected	1st:zysh group name, 2st:zysh group name
cannot create, too many groups (>%d)	1st:max group num
%s: cannot find entry %s	1st:zysh group name, 2st:zysh entry name
%s: cannot remove entry %s	1st:zysh group name, 2st:zysh entry name
List OPS	
can't alloc entry: %s!	1st:zysh entry name
can't retrieve entry: %s!	1st:zysh entry name
can't get entry: %s!	1st:zysh entry name
can't print entry: %s!	1st:zysh entry name
%s: cannot retrieve entries from list!	1st:zysh list name
can't get name for entry %d!	1st:zysh entry index
can't get reference count: %s!	1st:zysh list name
can't print entry name: %s!	1st:zysh entry name
Can't append entry: %s!	1st:zysh entry name
Can't set entry: %s!	1st:zysh entry name
Can't define entry: %s!	1st:zysh entry name
%s: list is full!	1st:zysh list name
Can't undefine %s	1st:zysh list name

Table 243 ZySH Logs (continued)

LOG MESSAGE	DESCRIPTION
Can't remove %s	1st:zysh list name
Table OPS	
%s: cannot retrieve entries from table!	1st:zysh table name
%s: index is out of range!	1st:zysh table name
%s: cannot set entry #%d	1st:zysh table name,2st: zysh entry num
%s: table is full!	1st:zysh table name
%s: invalid old/new index!	1st:zysh table name
Unable to move entry #%d!	1st:zysh entry num
%s: invalid index!	1st:zysh table name
Unable to delete entry #%d!	1st:zysh entry num
Unable to change entry #%d!	1st:zysh entry num
%s: cannot retrieve entries from table!	1st:zysh table name
%s: invalid old/new index!	1st:zysh table name
Unable to move entry #%d!	1st:zysh entry num
%s: apply failed at initial stage!	1st:zysh table name
%s: apply failed at main stage!	1st:zysh table name
%s: apply failed at closing stage!	1st:zysh table name

Table 244 ADP Logs

LOG MESSAGE	DESCRIPTION
from <zone> to <zone> [type=<type>] <message> , Action: <action>, Severity: <severity>	<p>The ZyWALL detected an anomaly in traffic traveling between the specified zones.</p> <p>The <type> = {scan-detection(<attack>) flood-detection(<attack>) http-inspection(<attack>) tcp-decoder(<attack>)}. The <message> gives details about the attack, although the message is dropped if the log is more than 128 characters. The <action> is what the ZyWALL did with the packet. The <severity> is the threat level (very low, low, medium, high, or severe).</p>
Enable ADP succeeded.	ADP was turned on.
Disable ADP succeeded.	ADP was turned off.
ADP rule <num> has been deleted.	The specified ADP rule has been deleted.
ADP rule <num> has been moved to <num>.	The ADP rule with the specified index number (first num) was moved to the specified index number (second num).
New ADP rule has been appended.	An ADP rule has been added to the end of the list.
ADP rule <num> has been inserted.	An ADP rule has been inserted. <num> is the number of the new rule.
ADP rule <num> has been modified.	The ADP rule of the specified number has been changed.
ADP profile <name> has been deleted.	The ADP rule with the specified name has been removed.
ADP profile <name> has been changed to <name>.	An ADP rule's name has been changed from first <name> to the second <name>.
ADP profile <name> has been created.	An ADP profile with the specified name has been added.
ADP profile <name> has been modified.	The ADP rule with the specified name has been changed.
Packet payload length is over the maximum system handle length	The ZyWALL's ADP feature detected a packet with a length over 16000 bytes.
LAND attack packet. Source IP is the same as Destination IP.	The ZyWALL's ADP feature detected traffic with the same IP address set as both the source and the destination.

Table 245 User Logs

LOG MESSAGE	DESCRIPTION
%s %s from %s has logged in ZyWALL	A user logged into the ZyWALL. 1st %s: The type of user account. 2nd %s: The user's user name. 3rd %s: The name of the service the user is using (HTTP, HTTPS, FTP, Telnet, SSH, or console).
%s %s from %s has logged out ZyWALL	A user logged out of the ZyWALL. 1st %s: The type of user account. 2nd %s: The user's user name. 3rd %s: The name of the service the user is using (HTTP, HTTPS, FTP, Telnet, SSH, or console).
%s %s from %s has been logged out ZyWALL (re-auth timeout)	The ZyWALL is signing the specified user out due to a re-authentication timeout. 1st %s: The type of user account. 2nd %s: The user's user name. 3rd %s: The name of the service the user is using (HTTP, HTTPS, FTP, Telnet, SSH, or console).
%s %s from %s has been logged out ZyWALL (lease timeout)	The ZyWALL is signing the specified user out due to a lease timeout. 1st %s: The type of user account. 2nd %s: The user's user name. 3rd %s: The name of the service the user is using (HTTP, HTTPS, FTP, Telnet, SSH, or console).
%s %s from %s has been logged out ZyWALL (idle timeout)	The ZyWALL is signing the specified user out due to an idle timeout. 1st %s: The type of user account. 2nd %s: The user's user name. 3rd %s: The name of the service the user is using (HTTP, HTTPS, FTP, Telnet, SSH, or console).
Console has been put into lockout state	Too many failed login attempts were made on the console port so the ZyWALL is blocking login attempts on the console port.
Address %u.%u.%u.%u has been put into lockout state	Too many failed login attempts were made from an IP address so the ZyWALL is blocking login attempts from that IP address. %u.%u.%u.%u: the source address of the user's login attempt

Table 245 User Logs (continued)

LOG MESSAGE	DESCRIPTION
Failed login attempt to ZyWALL from %s (login on a lockout address)	A login attempt came from an IP address that the ZyWALL has locked out. %u.%u.%u.%u: the source address of the user's login attempt
Failed login attempt to ZyWALL from %s (reach the max. number of user)	The ZyWALL blocked a login because the maximum login capacity for the particular service has already been reached. %s: service name
Failed login attempt to ZyWALL from %s (reach the max. number of simultaneous logon)	The ZyWALL blocked a login because the maximum simultaneous login capacity for the administrator or access account has already been reached. %s: service name
User %s has been denied access from %s	The ZyWALL blocked a login according to the access control configuration. %s: service name
User %s has been denied access from %s	The ZyWALL blocked a login attempt by the specified user name because of an invalid user name or password. 2nd %s: service name

Table 246 myZyXEL.com Logs

LOG MESSAGE	DESCRIPTION
Send registration message to MyZyXEL.com server has failed.	The device was not able to send a registration message to MyZyXEL.com.
Get server response has failed.	The device sent packets to the MyZyXEL.com server, but did not receive a response. The root cause may be that the connection is abnormal.
Timeout for get server response.	zysh need to catch MyZyXEL.com agent's return code, this log will be shown when timeout.
User has existed.	The user name already exists in MyZyXEL.com's database. So the user can't use it for device registration and needs to specify another one.
User does not exist.	The user name does not yet exist in MyZyXEL.com's database. So the user can use it for device registration.
Internal server error.	MyZyXEL.com's database had an error when checking the user name.
Device registration has failed:%s.	Device registration failed, an error message returned by the MyZyXEL.com server will be appended to this log. %s: error message returned by the myZyXEL.com server
Device registration has succeeded.	The device registered successfully with the myZyXEL.com server.

Table 246 myZyXEL.com Logs (continued)

LOG MESSAGE	DESCRIPTION
Registration has failed. Because of lack must fields.	The device received an incomplete response from the myZyXEL.com server and it caused a parsing error for the device.
%s: Trial service activation has failed: %s.	Trail service activation failed for the specified service, an error message returned by the MyZyXEL.com server will be appended to this log. 1st %s: service name 2nd %s: error message returned by the myZyXEL.com server
%s: Trial service activation has succeeded.	Trail service was activated successfully for the specified service. %s: service name
Trial service activation has failed. Because of lack must fields.	The device received an incomplete response from the myZyXEL.com server and it caused a parsing error for the device.
Standard service activation has failed: %s.	Standard service activation failed, this log will append an error message returned by the MyZyXEL.com server. %s: error message returned by the myZyXEL.com server
Standard service activation has succeeded.	Standard service activation has succeeded.
Standard service activation has failed. Because of lack must fields.	The device received an incomplete response from the myZyXEL.com server and it caused a parsing error for the device.
Service expiration check has failed: %s.	The service expiration day check failed, this log will append an error message returned by the MyZyXEL.com server. %s: error message returned by myZyXEL.com server
Service expiration check has succeeded.	The service expiration day check was successful.
Service expiration check has failed. Because of lack must fields.	The device received an incomplete response from the myZyXEL.com server and it caused a parsing error for the device.
Server setting error.	The device could not retrieve the myZyXEL.com server's IP address or FQDN from local.
Resolve server IP has failed.	The device could not resolve the myZyXEL.com server's FQDN to an IP address through gethostbyname().
Verify server's certificate has failed.	The device could not process an HTTPS connection because it could not verify the myZyXEL.com server's certificate.
Connect to MyZyXEL.com server has failed.	The device could not connect to the MyZyXEL.com server.
Do account check.	The device started to check whether or not the user name in MyZyXEL.com's database.

Table 246 myZyXEL.com Logs (continued)

LOG MESSAGE	DESCRIPTION
Do device register.	The device started device registration.
Do trial service activation.	The device started trail service activation.
Do standard service activation.	The device started standard service activation.
Do expiration check.	The device started the service expiration day check.
Build query message has failed.	Some information was missing in the packets that the device sent to the MyZyXEL.com server.
Parse receive message has failed.	The device cannot parse the response returned by the MyZyXEL.com server. Maybe some required fields are missing.
Resolve server IP has failed. Update stop.	The update has stopped because the device couldn't resolve the myZyXEL.com server's FQDN to an IP address through gethostbyname().
Verify server's certificate has failed. Update stop.	The device could not process an HTTPS connection because it could not verify the myZyXEL.com server's certificate. The update has stopped.
Send download request to update server has failed.	The device's attempt to send a download message to the update server failed.
Get server response has failed.	The device sent packets to the MyZyXEL.com server, but did not receive a response. The root cause may be that the connection is abnormal.
Timeout for get server response.	zysh need to catch MyZyXEL.com agent's return code, this log will be shown when timeout.
Send update request to update server has failed.	The device could not send an update message to the update server.
Update has failed. Because of lack must fields.	The device received an incomplete response from the update server and it caused a parsing error for the device.
Update server is busy now. File download after %d seconds.	The update server was busy so the device will wait for the specified number of seconds and send the download request to the update server again.
Device has latest file. No need to update.	The device already has the latest version of the file so no update is needed.
Device has latest signature file; no need to update	The device already has the latest version of the signature file so no update is needed.
Connect to update server has failed.	The device cannot connect to the update server.
Wrong format for packets received.	The device cannot parse the response returned by the server. Maybe some required fields are missing.
Server setting error. Update stop.	The device could not resolve the update server's FQDN to an IP address through gethostbyname(). The update process stopped.

Table 246 myZyXEL.com Logs (continued)

LOG MESSAGE	DESCRIPTION
Build query message failed.	Some information was missing in the packets that the device sent to the server.
Resolve server IP has failed.	The device could not resolve the myZyXEL.com server's FQDN to an IP address through gethostbyname().
Connect to MyZyXEL.com server has failed.	The device could not connect to the MyZyXEL.com server.
Build query message has failed.	Some information was missing in the packets that the device sent to the server.
Verify server's certificate has failed.	The device could not process an HTTPS connection because it could not verify the server's certificate.
Get server response has failed.	The device sent packets to the server, but did not receive a response. The root cause may be that the connection is abnormal.
Expiration daily-check has failed:%s.	The daily check for service expiration failed, an error message returned by the MyZyXEL.com server will be appended to this log. %s: error message returned by myZyXEL.com server
Do expiration daily-check has failed. Because of lack must fields.	The device received an incomplete response to the daily service expiration check and the packets caused a parsing error for the device.
Server setting error.	The device could not retrieve the server's IP address or FQDN from local.
Do expiration daily-check has failed.	The daily check for service expiration failed.
Do expiration daily-check has succeeded.	The daily check for service expiration was successful.
Expiration daily-check will trigger PPP interface. Do self-check.	Before the device sends an expiration day check packet, it needs to check whether or not it will trigger a PPP connection.
System bootup. Do expiration daily-check.	The device processes a service expiration day check immediately after it starts up.
After register. Do expiration daily-check immediately.	The device processes a service expiration day check immediately after device registration.
Time is up. Do expiration daily-check.	The processes a service expiration day check every 24 hrs.
Read MyZyXEL.com storage has failed.	Read data from EEPROM has failed.
Open /proc/MRD has failed.	This error message is shown when getting MAC address.

Table 246 myZyXEL.com Logs (continued)

LOG MESSAGE	DESCRIPTION
Content-Filter service has expired.	The content filtering service period has expired. The device can find this through either a service expiration day check via MyZyXEL.com server or by the device's own count.
Unknown TLS/SSL version: %d.	The device only supports SSLv3 protocol. %d: SSL version assigned by client.
Load trusted root certificates has failed.	The device needs to load the trusted root certificate before the device can verify a server's certificate. This log displays if the device failed to load it.
Certificate has expired.	Verification of a server's certificate failed because it has expired.
Self signed certificate.	Verification of a server's certificate failed because it is self-signed.
Self signed certificate in certificate chain.	Verification of a server's certificate failed because there is a self-signed certificate in the server's certificate chain.
Verify peer certificates has succeeded.	The device verified a server's certificate while processing an HTTPS connection.
Certification verification failed: Depth: %d, Error Number(%d):%s.	Verification of a server's certificate failed while processing an HTTPS connection. This log identifies the reason for the failure. 1st %d: certificate chain level 2nd %d: error number %s: error message
Certificate issuer name:%s.	Verification of the specified certificate failed because the device could not get the certificate's issuer name. %s is the certificate name.
The wrong format for HTTP header.	The header format of a packet returned by a server is wrong.
Timeout for get server response.	After the device sent packets to a server, the device did not receive any response from the server. The root cause may be a network delay issue.
Download file size is wrong.	The file size downloaded for AS is not identical with content-length
Parse HTTP header has failed.	Device can't parse the HTTP header in a response returned by a server. Maybe some HTTP headers are missing.

Table 247 IKE Logs

LOG MESSAGE	DESCRIPTION
Peer has not announced DPD capability	The remote IPsec router has not announced its dead peer detection (DPD) capability to this device.
[COOKIE] Invalid cookie, no sa found	Cannot find SA according to the cookie.

Table 247 IKE Logs (continued)

LOG MESSAGE	DESCRIPTION
[DPD] No response from peer. Using existing Phase-1 SA in %u seconds. Trying with Phase-1 rekey.	The device's DPD feature has not detected a response from the remote IPsec router. %u is the retry time.
[HASH] : Tunnel [%s] Phase 1 hash mismatch	%s is the tunnel name. When negotiating Phase-1, the exchange hash did not match.
[HASH] : Tunnel [%s] Phase 2 hash mismatch"	%s is the tunnel name. When negotiating Phase-2, the calculated quick mode authentication hash did not match.
[ID] : Invalid ID information	ID payload is not valid (in Phase-1 is local/peer ID, in Phase-2 is local/remote policy).
[ID] : Tunnel [%s] Local IP mismatch	%s is the tunnel name. When negotiating Phase-1, the local tunnel IP did not match the My IP in VPN gateway.
[ID] : Tunnel [%s] My IP mismatch	%s is the tunnel name. When negotiating Phase-1 and selecting matched proposal, My IP Address could not be resolved.
[ID] : Tunnel [%s] Phase 1 ID mismatch	%s is the tunnel name. When negotiating Phase-1, the peer ID did not match.
[ID] : Tunnel [%s] Phase 2 Local ID mismatch	%s is the tunnel name. When negotiating Phase-2 and checking IPsec SAs or the ID is IPv6 ID.
[ID] : Tunnel [%s] Phase 2 Remote ID mismatch	%s is the tunnel name. When negotiating Phase-2 and checking IPsec SAs or the ID is IPv6 ID.
[ID] : Tunnel [%s] Remote IP mismatch	%s is the tunnel name. When negotiating Phase-1, the peer tunnel IP did not match the secure gateway address in VPN gateway.
[SA] : Malformed IPsec SA proposal	When selecting a matched proposal, some protocol was given more than once.
[SA] : No proposal chosen	When selecting a matched proposal in phase-1 or phase-2, so proposal was selected.
[SA] : Tunnel [%s] Phase 1 authentication algorithm mismatch	%s is the tunnel name. When negotiating Phase-1, the authentication algorithm did not match.
[SA] : Tunnel [%s] Phase 1 authentication method mismatch	%s is the tunnel name. When negotiating Phase-1, the authentication method did not match.
[SA] : Tunnel [%s] Phase 1 encryption algorithm mismatch	%s is the tunnel name. When negotiating Phase-1, the encryption algorithm did not match.
[SA] : Tunnel [%s] Phase 1 invalid protocol	%s is the tunnel name. When negotiating Phase-1, the packet was not a ISKAMP packet in the protocol field.
[SA] : Tunnel [%s] Phase 1 invalid transform	%s is the tunnel name. When negotiating Phase-1, the transform ID was invalid.

Table 247 IKE Logs (continued)

LOG MESSAGE	DESCRIPTION
[SA] : Tunnel [%s] Phase 1 key group mismatch	%s is the tunnel name. When negotiating Phase-1, the DH group of the attribute list `attrs' did not match the security policy.
[SA] : Tunnel [%s] Phase 1 negotiation mode mismatch	%s is the tunnel name. When negotiating Phase-1, the negotiation mode did not match.
[SA] : Tunnel [%s] Phase 2 authentication algorithm mismatch	%s is the tunnel name. When negotiating Phase-2, the authentication algorithm did not match.
[SA] : Tunnel [%s] Phase 2 encapsulation mismatch	%s is the tunnel name. When negotiating Phase-2, the encapsulation did not match.
[SA] : Tunnel [%s] Phase 2 encryption algorithm mismatch	%s is the tunnel name. When negotiating Phase-2, the encryption algorithm did not match.
[SA] : Tunnel [%s] Phase 2 pfs mismatch	%s is the tunnel name. When negotiating Phase-2, the PFS specified did not match.
[SA] : Tunnel [%s] Phase 2 pfs unsupported: %d	%s is the tunnel name. When negotiating Phase-2, this device does not support the PFS specified.
[SA] : Tunnel [%s] Phase 2 SA encapsulation mismatch	%s is the tunnel name. When negotiating Phase-2, the SA encapsulation did not match.
[SA] : Tunnel [%s] Phase 2 SA protocol mismatch	%s is the tunnel name. When negotiating Phase-2, the SA protocol did not match.
[SA] : Tunnel [%s] SA sequence size mismatch	%s is the tunnel name. When negotiating Phase-2, the SA sequence size did not match.
[XCHG] exchange type is not IP, AGGR, or INFO	This device is the responder and this is the initiator's first packet, but exchange type is not IP, AGGR, or INFO and the packet is ignored.
Cannot resolve My IP Addr %s for Tunnel [%s]	1st %s is my ip address. 2nd %s is the tunnel name. When selecting a matched proposal in phase-1, the engine could not get My-IP address.
Cannot resolve Secure Gateway Addr %s for Tunnel [%s]	1st %s is my ip address. 2nd %s is the tunnel name; When selecting a matched proposal in phase-1, the engine could not get the correct secure gateway address.
Could not dial dynamic tunnel "%s"	%s is the tunnel name. The tunnel is a dynamic tunnel and the device cannot dial it.
Could not dial incomplete tunnel "%s"	%s is the tunnel name. The tunnel setting is not complete.
Could not dial manual key tunnel "%s"	%s is the tunnel name. The manual key tunnel cannot be dialed.
DPD response with invalid ID	When receiving a DPD response with invalid ID ignored.
DPD response with no active request	When receiving a DPD response with no active query.

Table 247 IKE Logs (continued)

LOG MESSAGE	DESCRIPTION
IKE Packet Retransmit	When retransmitting the IKE packets.
Phase 1 IKE SA process done	When Phase 1 negotiation is complete.
Recv Main Mode request from [%s]	%s is the remote name; When receiving a request to enter Main mode.
Recv Aggressive Mode request from [%s]	%s is the remote name; When receiving a request to enter Aggressive mode.
Recv:[SA][KE][ID][CERT][CR][HASH][SIG][NONCE][DEL][VID][ATTR][NOTFY:%s]	This is a combined message for incoming IKE packets
Send Main Mode request to [%s]	%s is the remote name. The device sent a request to enter Main Mode.
Send Aggressive Mode request to [%s]	%s is the remote name. The device sent a request to enter Aggressive Mode.
Send:[SA][KE][ID][CERT][CR][HASH][SIG][NONCE][DEL][VID][ATTR][NOTFY:%s]	This is a combined message for outgoing IKE packets.
Start Phase 2: Quick Mode	Indicates the beginning of phase 2 using quick mode.
The cookie pair is : 0x%08x%08x / 0x%08x%08x	Indicates the initiator/responder cookie pair.
The IPsec tunnel "%s" is already established	%s is the tunnel name. When dialing a tunnel, the tunnel is already dialed.
Tunnel [%s] built successfully	%s is the tunnel name. The phase-2 tunnel negotiation is complete.
Tunnel [%s] Phase 1 pre-shared key mismatch	%s is the tunnel name. When negotiating phase-1, the pre-shared key did not match.
Tunnel [%s] Recving IKE request	%s is the tunnel name. The device received an IKE request.
Tunnel [%s] Sending IKE request	%s is the tunnel name. The device sent an IKE request.
Tunnel [%s] IKE Negotiation is in process	%s is the tunnel name. When IKE request is already sent but still attempting to dial a tunnel.
VPN gateway %s was disabled	%s is the gateway name. An administrator disabled the VPN gateway.
VPN gateway %s was enabled	%s is the gateway name. An administrator enabled the VPN gateway.
XAUTH fail! My name: %s	%s is the my xauth name. This indicates that my name is invalid.
XAUTH fail! Remote user: %s	%s is the remote xauth name. This indicates that a remote user's name is invalid.

Table 247 IKE Logs (continued)

LOG MESSAGE	DESCRIPTION
XAUTH succeed! My name: %s	%s is the my xauth name. This indicates that my name is valid.
XAUTH succeed! Remote user: %s	%s is the remote xauth name. This indicate that a remote user's name is valid
Dynamic Tunnel [%s:%s:0x%x:%s] built successfully	The variables represent the phase 1 name, tunnel name, SPI and the xauth name (optional). The phase-2 tunnel negotiation is complete.
Dynamic Tunnel [%s:%s:0x%x:0x%x:%s] rekeyed successfully	The variables represent the phase 1 name, tunnel name, old SPI, new SPI and the xauth name (optional). The tunnel was rekeyed successfully.
Tunnel [%s:%s:0x%x:%s] built successfully	The variables represent the phase 1 name, tunnel name, SPI and the xauth name (optional). The phase-2 tunnel negotiation is complete.
Tunnel [%s:%s:0x%x:0x%x:%s] rekeyed successfully	The variables represent the phase 1 name, tunnel name, old SPI, new SPI and the xauth name (optional). The tunnel was rekeyed successfully.
Tunnel [%s:%s] Phase 1 pre-shared key mismatch	The variables represent the phase 1 name and tunnel name. When negotiating phase-1, the pre-shared keys did not match.
Tunnel [%s:%s] Recving IKE request	The variables represent the phase 1 name and tunnel name. The device received an IKE request.
Tunnel [%s:%s] Sending IKE request	The variables represent the phase 1 name and tunnel name. The device sent an IKE request.
Tunnel [%s:0x%x] is disconnected	The variables represent the tunnel name and the SPI of a tunnel that was disconnected.
Tunnel [%s] rekeyed successfully	%s is the tunnel name. The tunnel was rekeyed successfully.

Table 248 IPsec Logs

LOG MESSAGE	DESCRIPTION
Corrupt packet, Inbound transform operation fail	The device received corrupt IPsec packets and could not process them.
Encapsulated packet too big with length	An outgoing packet needed to be transformed but was longer than 65535.
Get inbound transform fail	When performing inbound processing for incoming IPSEC packets and ICMPs related to them, the engine cannot obtain the transform context.
Get outbound transform fail	When outgoing packet need to be transformed, the engine cannot obtain the transform context.
Inbound transform operation fail	After encryption or hardware accelerated processing, the hardware accelerator dropped a packet (resource shortage, corrupt packet, invalid MAC, and so on).

Table 248 IPsec Logs (continued)

LOG MESSAGE	DESCRIPTION
Outbound transform operation fail	After encryption or hardware accelerated processing, the hardware accelerator dropped a packet (e.g., resource overflow, corrupt packet, and so on).
Packet too big with Fragment Off	An outgoing packet needed to be transformed, but the fragment flag was off and the packet was too big.
SPI:0x%x SEQ:0x%x Execute transform step fail, ret=%d	The variables represent the SPI, sequence number and the error number. When trying to perform transforming, the engine returned an error.
SPI:0x%x SEQ:0x%x No rule found, Dropping packet	The variables represent the SPI and the sequence number. The packet did not match the tunnel policy and was dropped.
SPI:0x%x SEQ:0x%x Packet Anti-Replay detected	The variables represent the SPI and the sequence number. The device received a packet again (that it had already received).
VPN connection %s was disabled.	%s is the VPN connection name. An administrator disabled the VPN connection.
VPN connection %s was enabled.	%s is the VPN connection name. An administrator enabled the VPN connection.
Due to active connection allowed exceeded, %s was deleted.	%s is the VPN connection name. The number of active connections exceeded the maximum allowed.

Table 249 Firewall Logs

LOG MESSAGE	DESCRIPTION
priority:%lu, from %s to %s, service %s, %s	1st variable is the global index of rule, 2nd is the from zone, 3rd is the to zone, 4th is the service name, 5th is ACCEPT/DROP/REJECT.
%s:%d: in %s():	Firewall is dead, trace to %s is which file, %d is which line, %s is which function
Firewall has been %s.	%s is enabled/disabled
Firewall rule %d has been moved to %d.	1st %d is the old global index of rule, 2nd %d is the new global index of rule
Firewall rule %d has been deleted.	%d is the global index of rule
Firewall rules have been flushed.	Firewall rules were flushed
Firewall rule %d was %s.	%d is the global index of rule, %s is appended/inserted/modified
Firewall %s %s rule %d was %s.	1st %s is from zone, 2nd %s is to zone, %d is the index of the rule 3rd %s is appended/inserted/modified

Table 249 Firewall Logs (continued)

LOG MESSAGE	DESCRIPTION
Firewall %s %s rule %d has been moved to %d.	1st %s is from zone, 2nd %s is to zone, 1st %d is the old index of the rule 2nd %d is the new index of the rule
Firewall %s %s rule %d has been deleted.	1st %s is from zone, 2nd %s is to zone, %d is the index of the rule
Firewall %s %s rules have been flushed.	1st %s is from zone, 2nd %s is to zone
abnormal TCP flag attack detected	Abnormal TCP flag attack detected
invalid state detected	Invalid state detected
The Asymmetrical Route has been enabled.	Asymmetrical route has been turned on.
The Asymmetrical Route has been disabled.	Asymmetrical Route has been turned off.

Table 250 Sessions Limit Logs

LOG MESSAGE	DESCRIPTION
Maximum sessions per host (%d) was exceeded.	%d is maximum sessions per host.

Table 251 Policy Route Logs

LOG MESSAGE	DESCRIPTION
Can't open bwm_entries	Policy routing can't activate BWM feature.
Can't open link_down	Policy routing can't detect link up/down status.
Cannot get handle from UAM, user-aware PR is disabled	User-aware policy routing is disabled due to some reason.
mblock: allocate memory failed!	Allocating policy routing rule fails: insufficient memory.
pt: allocate memory failed!	Allocating policy routing rule fails: insufficient memory.
To send message to policy route daemon failed!	Failed to send control message to policy routing manager.
The policy route %d allocates memory fail!	Allocating policy routing rule fails: insufficient memory. %d: the policy route rule number
The policy route %d uses empty user group!	Use an empty object group. %d: the policy route rule number

Table 251 Policy Route Logs (continued)

LOG MESSAGE	DESCRIPTION
The policy route %d uses empty source address group!	Use an empty object group. %d: the policy route rule number
The policy route %d uses empty destination address group!	Use an empty object group. %d: the policy route rule number
The policy route %d uses empty service group	Use an empty object group. %d: the policy route rule number
Policy-route rule %d was inserted.	Rules is inserted into system. %d: the policy route rule number
Policy-route rule %d was appended.	Rules is appended into system. %d: the policy route rule number
Policy-route rule %d was modified.	Rule is modified. %d: the policy route rule number
Policy-route rule %d was moved to %d.	Rule is moved. 1st %d: the original policy route rule number 2nd %d: the new policy route rule number
Policy-route rule %d was deleted.	Rule is deleted. %d: the policy route rule number
Policy-route rules were flushed.	Policy routing rules are cleared.
BWM has been activated.	The global setting for bandwidth management on the ZyWALL has been turned on.
BWM has been deactivated.	The global setting for bandwidth management on the ZyWALL has been turned off.
Interface %s alive, related policy route rules will be re-enabled	An interface came back up so the ZyWALL will use the related policy route rules again.
Interface %s dead, related policy route rules will be disabled	An interface went down so the ZyWALL will stop using the related policy route rules.
Trunk %s alive, related policy route rules will be re-enabled	A trunk came back up so the ZyWALL will use the related policy route rules again.
Trunk %s dead, related policy route rules will be disabled	A trunk went down so the ZyWALL will stop using the related policy route rules.

Table 252 Built-in Services Logs

LOG MESSAGE	DESCRIPTION
User on %u.%u.%u.%u has been denied access from %s	HTTP/HTTPS/TELNET/SSH/FTP/SNMP access to the device was denied. %u.%u.%u.%u is IP address %s is HTTP/HTTPS/SSH/SNMP/FTP/TELNET
HTTPS certificate:%s does not exist. HTTPS service will not work.	An administrator assigned a nonexistent certificate to HTTPS. %s is certificate name assigned by user
HTTPS port has been changed to port %s.	An administrator changed the port number for HTTPS. %s is port number
HTTPS port has been changed to default port.	An administrator changed the port number for HTTPS back to the default (443).
HTTP port has changed to port %s.	An administrator changed the port number for HTTP. %s is port number assigned by user
HTTP port has changed to default port.	An administrator changed the port number for HTTP back to the default (80).
SSH port has been changed to port %s.	An administrator changed the port number for SSH. %s is port number assigned by user
SSH port has been changed to default port.	An administrator changed the port number for SSH back to the default (22).
SSH certificate:%s does not exist. SSH service will not work.	An administrator assigned a nonexistent certificate to SSH. %s is certificate name assigned by user
SSH certificate:%s format is wrong. SSH service will not work.	After an administrator assigns a certificate for SSH, the device needs to convert it to a key used for SSH. %s is certificate name assigned by user
TELNET port has been changed to port %s.	An administrator changed the port number for TELNET. %s is port number assigned by user
TELNET port has been changed to default port.	An administrator changed the port number for TELNET back to the default (23).
FTP certificate:%s does not exist.	An administrator assigned a nonexistent certificate to FTP. %s is certificate name assigned by user
FTP port has been changed to port %s.	An administrator changed the port number for FTP. %s is port number assigned by user
FTP port has been changed to default port.	An administrator changed the port number for FTP back to the default (21).

Table 252 Built-in Services Logs (continued)

LOG MESSAGE	DESCRIPTION
SNMP port has been changed to port %s.	An administrator changed the port number for SNMP. %s is port number assigned by user
SNMP port has been changed to default port.	An administrator changed the port number for SNMP back to the default (161).
Console baud has been changed to %s.	An administrator changed the console port baud rate. %s is baud rate assigned by user
Console baud has been reset to %d.	An administrator changed the console port baud rate back to the default (115200). %d is default baud rate
DHCP's DNS option:%s has changed.	DHCP pool's DNS option support from WAN interface. If this interface is unlink/disconnect or link/connect, this log will be shown. %s is interface name. The DNS option of DHCP pool has retrieved from it
Set timezone to %s.	An administrator changed the time zone. %s is time zone value
Set timezone to default.	An administrator changed the time zone back to the default (0).
Enable daylight saving.	An administrator turned on daylight saving.
Disable daylight saving.	An administrator turned off daylight saving.
DNS access control rules have been reached the maximum number.	An administrator tried to add more than the maximum number of DNS access control rules (64).
DNS access control rule %u of DNS has been appended.	An administrator added a new rule. %u is rule number
DNS access control rule %u has been inserted.	An administrator inserted a new rule. %u is rule number
DNS access control rule %u has been appended	An administrator appended a new rule. %u is rule number
DNS access control rule %u has been modified	An administrator modified the rule %u. %u is rule number
DNS access control rule %u has been deleted.	An administrator removed the rule %u. %u is rule number

Table 252 Built-in Services Logs (continued)

LOG MESSAGE	DESCRIPTION
DNS access control rule %u has been moved to %d.	An administrator moved the rule %u to index %d. %u is previous index %d variable is current index
The default record of Zone Forwarder have reached the maximum number of 128 DNS servers.	The default record DNS servers is more than 128.
Interface %s ping check is successful. Zone Forwarder adds DNS servers in records.	Ping check ok, add DNS servers in bind. %s is interface name
Interface %s ping check is failed. Zone Forwarder removes DNS servers in records.	Ping check failed, remove DNS servers from bind. %s is interface name
Interface %s ping check is disabled. Zone Forwarder adds DNS servers in records.	Ping check disabled, add DNS servers in bind. %s is interface name
Wizard apply DNS server failed.	Wizard apply DNS server failed.
Wizard adds DNS server %s failed because DNS zone setting has conflictd.	Wizard apply DNS server failed because DNS zone conflicted. %s is the IP address of the DNS server
Wizard adds DNS server %s failed because Zone Forwarder numbers have reached the maximum number of 32.	Wizard apply DNS server fail because the device already has the maximum number of DNS records configured. %s is IP address of the DNS server.
Access control rules of %s have reached the maximum number of %u	The maximum number of allowable rules has been reached. %s is HTTP/HTTPS/SSH/SNMP/FTP/TELNET. %u is the maximum number of access control rules.
Access control rule %u of %s was appended.	A new built-in service access control rule was appended. %u is the index of the access control rule. %s is HTTP/HTTPS/SSH/SNMP/FTP/TELNET.
Access control rule %u of %s was inserted.	An access control rule was inserted successfully. %u is the index of the access control rule. %s is HTTP/HTTPS/SSH/SNMP/FTP/TELNET.

Table 252 Built-in Services Logs (continued)

LOG MESSAGE	DESCRIPTION
Access control rule %u of %s was modified.	An access control rule was modified successfully. %u is the index of the access control rule. %s is HTTP/HTTPS/SSH/SNMP/FTP/TELNET.
Access control rule %u of %s was deleted.	An access control rule was removed successfully. %u is the index of the access control rule. %s is HTTP/HTTPS/SSH/SNMP/FTP/TELNET.
Access control rule %d of %s was moved to %d.	An access control rule was moved successfully. 1st %d is the previous index . %s is HTTP/HTTPS/SSH/SNMP/FTP/TELNET. 2nd %d is current previous index.
SNMP trap can not be sent successfully	Cannot send a SNMP trap to a remote host due to network error

Table 253 System Logs

LOG MESSAGE	DESCRIPTION
Port %d is up!!	When LINK is up, %d is the port number.
Port %d is down!!	When LINK is down, %d is the port number.
%s is dead at %s	A daemon (process) is gone (was killed by the operating system). 1st %s: Daemon Name, 2nd %s: date and time
%s process count is incorrect at %s	The count of the listed process is incorrect. 1st %s: Daemon Name, 2nd %s: date and time
%s becomes Zombie at %s	A process is present but not functioning. 1st %s: Daemon Name, 2nd %s: date and time When memory usage exceed threshold-max, memory usage reaches %d%% :mem-threshold-max. When local storage usage exceeds threshold-max, %s: Partition name file system usage reaches %d%%: disk-threshold-max. When memory usage drops below threshold-min, System Memory usage drops below the threshold of %d%%: mem-threshold-min. When local storage usage drops below threshold-min, %s: partition_name file system drops below the threshold of %d%%: disk-threshold-min.
DHCP Server executed with cautious mode enabled	DHCP Server executed with cautious mode enabled.

Table 253 System Logs (continued)

LOG MESSAGE	DESCRIPTION
DHCP Server executed with cautious mode disabled	DHCP Server executed with cautious mode disabled.
Received packet is not an ARP response packet	A packet was received but it is not an ARP response packet.
Receive an ARP response	The device received an ARP response.
Receive ARP response from %s (%s)	The device received an ARP response from the listed source.
The request IP is: %s, sent from %s	The device accepted a request.
Received ARP response NOT for the request IP address	The device received an ARP response that is NOT for the requested IP address.
Receive an ARP response from the client issuing the DHCP request	The device received an ARP response from the client issuing the DHCP request.
Receive an ARP response from an unknown client	The device received an ARP response from an unknown client.
In total, received %d arp response packets for the requested IP address	The device received the specified total number of ARP response packets for the requested IP address.
Clear arp cache successfully.	The ARP cache was cleared successfully.
Client MAC address is not an Ethernet address	A client MAC address is not an Ethernet address.
DHCP request received via interface %s (%s:%s), src_mac: %s with requested IP: %s	The device received a DHCP request through the specified interface.
IP confliction is detected. Send back DHCP-NAK.	IP conflict was detected. Send back DHCP-NAK.
Clear ARP cache done	Clear ARP cache done.
Set manual time has succeeded. Current time is %s	The device date and time was changed manually. %s is the date and time.
NTP update successful, current time is %s	The device successfully synchronized with a NTP time server . %s is the date and time.
NTP update failed	The device was not able to synchronize with the NTP time server successfully.

Table 253 System Logs (continued)

LOG MESSAGE	DESCRIPTION
Device is rebooted by administrator!	An administrator restarted the device.
Insufficient memory.	Cannot allocate system memory.
Connect to dyndns server has failed.	Cannot connect to members.dyndns.org to update DDNS.
Update the profile %s has failed because of strange server response.	Update profile failed because the response was strange, %s is the profile name.
Update the profile %s has succeeded because the IP address of FQDN %s was not changed.	Update profile succeeded, because the IP address of profile is unchanged, %s is the profile name.
Update the profile %s has succeeded.	Update profile succeeded, %s is the profile name.
Update the profile %s has failed because the FQDN %s is invalid.	Update profile failed because FQDN for the profile is invalid for DynDNS, 1st %s is the profile name, 2nd %s is the FQDN of the profile.
Update the profile %s has failed because the FQDN %s is malformed.	The FQDN format is malformed for DynDNS server, 1st %s is the profile name, 2nd %s is the FQDN of the profile.
Update the profile %s has failed because the FQDN %s is not under your control.	The owner of this FQDN is not the user, 1st %s is the profile name, 2nd %s is the FQDN of the profile.
Update the profile %s has failed because the FQDN %s was blocked for abuse.	The FQDN is blocked by DynDNS, 1st %s is the profile name, 2nd %s is the FQDN of the profile.
Update the profile %s has failed because of authentication fail.	Try to update profile, but failed, because of authentication fail, %s is the profile name.
Update the profile %s has failed because of invalid system parameters.	Some system parameters are invalid to update FQDN, %s is the profile name.
Update the profile %s has failed because the FQDN %s was blocked.	The FQDN is blocked by DynDNS , 1st %s is the profile name, 2nd %s is the FQDN of the profile.
Update the profile %s has failed because too many or too few hosts found.	%s is the profile name.
Update the profile %s has failed because of dyndns internal error	Update profile failed because of a dynsdns internal error, %s is the profile name.

Table 253 System Logs (continued)

LOG MESSAGE	DESCRIPTION
Update the profile %s has failed because the feature requested is only available to donators.	Update profile failed because the feature requested is only available to donators, %s is the profile name.
Update the profile %s has failed because of error response.	Update profile failed because the response is incorrect, %s is the profile name.
Update the profile %s has failed because %s.	Update profile failed, and show the response message, 1st %s is the profile name, 2nd %s is the reason.
Update the profile %s has failed because of unknown error.	Update profile failed because unknown error. Sometimes, the force authentication will result in this error, 1st %s is the profile name.
Update the profile %s has failed because Username was empty.	DDNS profile needs username, %s is the profile name.
Update the profile %s has failed because Password was empty.	DDNS profile needs password, %s is the profile name.
Update the profile %s has failed because Domain name was empty.	DDNS profile needs domain name, %s is the profile name.
Update the profile %s has failed because Custom IP was empty.	The DDNS profile's IP select type is custom, and a custom IP was not defined, %s is the profile name.
Update the profile %s has failed because WAN interface was empty.	If the DDNS profile's IP select type is iface, it needs a WAN iface, %s is the profile name.
Update the profile %s has failed because WAN interface was link-down.	DDNS profile cannot be updated for WAN IP because WAN iface is link-down, %s is the profile name.
Update the profile %s has failed because WAN interface was not connected.	DDNS profile cannot be updated for WAN IP because WAN iface is PPP and not connected, %s is the profile name.
Update the profile %s has failed because IP address of WAN interface was empty.	DDNS profile cannot be updated because the IP of WAN iface is 0.0.0.0, 1st %s is the profile name.
Update the profile %s has failed because ping-check of WAN interface has failed.	DDNS profile cannot be updated because the ping-check for WAN iface failed , %s is the profile name.
Disable DDNS has succeeded.	Disable DDNS.
Enable DDNS has succeeded.	Enable DDNS.

Table 253 System Logs (continued)

LOG MESSAGE	DESCRIPTION
DDNS profile %s has been renamed as %s.	Rename DDNS profile, 1st %s is the original profile name, 2nd %s is the new profile name.
DDNS profile %s has been deleted.	Delete DDNS profile, %s is the profile name,
DDNS Initialization has failed.	Initialize DDNS failed,
All DDNS profiles are deleted	All DDNS profiles have been removed.
Collect Diagnostic Information has failed - Server did not respond.	There was an error and the diagnostics were not completed.
Collect Diagnostic Information has succeeded.	The diagnostics scripts were executed successfully.
Port %d is up!!	The specified port has it's link up.
Port %d is down!!	The specified port has it's link down.
Release interface %s failed for packet capture.	Releasing of the specified interface's usage count failed while exiting the packet capture function.
Release address-object %s failed for packet capture.	Releasing of the specified address object's usage count failed while exiting the packet capture function.
The interface %s is inactive, packet capture for this interface will not take effect.	The specified interface is not activated so the packet capture for the interface will not take effect.
Directory packet_trace not existed. Create it automatically.	The packet trace did not exist so the ZyWALL created it automatically.
Directory debug not existed! Create it automatically.	A debug directory did not exist so the ZyWALL created it automatically.

Table 254 Connectivity Check Logs

LOG MESSAGE	DESCRIPTION
Can't open link_up2	Cannot recover routing status which is link-down.
Can not open %s.pid	Cannot open connectivity check process ID file. %s: interface name
Can not open %s.arg	Cannot open configuration file for connectivity check process. %s: interface name

Table 254 Connectivity Check Logs (continued)

LOG MESSAGE	DESCRIPTION
The connectivity-check is activate for %s interface	The link status of interface is still activate after check of connectivity check process. %s: interface name
The connectivity-check is fail for %s interface	The link status of interface is fail after check of connectivity check process. %s: interface name
Can't get gateway IP of %s interface	The connectivity check process can't get the gateway IP address for the specified interface. %s: interface name
Can't alloc memory	The connectivity check process can't get memory from OS.
Can't load %s module	The connectivity check process can't load module for check link-status. %s: the connectivity module, currently only ICMP available.
Can't handle 'isalive' function of %s module	The connectivity check process can't execute 'isalive' function from module for check link-status. %s: the connectivity module, currently only ICMP available.
Create socket error	The connectivity check process can't get socket to send packet.
Can't get IP address of %s interface	The connectivity check process can't get IP address of interface. %s: interface name.
Can't get flags of %s interface	The connectivity check process can't get interface configuration. %s: interface name
Can't get remote address of %s interface	The connectivity check process can't get remote address of PPP interface %s: interface name
Can't get NETMASK address of %s interface	The connectivity check process can't get netmask address of interface. %s: interface name
Can't get BROADCAST address of %s interface	The connectivity check process can't get broadcast address of interface %s: interface name
Can't use MULTICAST IP for destination	The connectivity check process can't use multicast address to check link-status.
The destination is invalid, because destination IP is broadcast IP	The connectivity check process can't use broadcast address to check link-status.

Table 254 Connectivity Check Logs (continued)

LOG MESSAGE	DESCRIPTION
Can't get MAC address of %s interface!	The connectivity check process can't get MAC address of interface. %s: interface name
To send ARP REQUEST error!	The connectivity check process can't send ARP request packet.
The %s routing status seted to DEAD by connectivity-check	The interface routing can't forward packet. %s: interface name
The %s routing status seted ACTIVATE by connectivity-check	The interface routing can forward packet. %s: interface name
The link status of %s interface is inactive	The specified interface failed a connectivity check.

Table 255 Routing Protocol Logs

LOG MESSAGE	DESCRIPTION
RIP on all interfaces have been stopped	Got the CLI command 'no router rip' to shut down RIP on all interfaces
Invalid RIP md5 authentication	RIP md5 authentication has been set without setting md5 authentication id and key first
Invalid RIP text authentication.	RIP text authentication has been set without setting authentication key first
RIP on interface %s has been activated.	RIP on interface %s has been activated. %s: Interface Name
RIP direction on interface %s has been changed to In-Only.	RIP direction on interface %s has been changed to In-Only. %s: Interface Name
RIP direction on interface %s has been changed to Out-Only.	RIP direction on interface %s has been changed to Out-Only. %s: Interface Name
RIP authentication mode has been changed to %s.	RIP authentication mode has been changed to text or md5.
RIP text authentication key has been changed.	RIP text authentication key has been changed.
RIP md5 authentication id and key have been changed.	RIP md5 authentication id and key have been changed.
RIP global version has been changed to %s.	RIP global version has been changed to version 1 or 2.
RIP redistribute OSPF routes has been enabled.	RIP redistribute OSPF routes has been enabled.

Table 255 Routing Protocol Logs (continued)

LOG MESSAGE	DESCRIPTION
RIP redistribute static routes has been enabled.	RIP redistribute static routes has been enabled.
RIP on interface %s has been deactivated.	RIP on interface %s has been deactivated. %s: Interface Name
RIP direction on interface %s has been changed to BiDir.	RIP direction on interface %s has been changed to BiDir. %s: Interface Name
RIP authentication has benn disabled.	RIP text or md5 authentication has been disabled.
RIP text authentication key has been deleted.	RIP text authentication key has been deleted.
RIP md5 authentication id and key have been deleted.	RIP md5 authentication id and key have been deleted.
RIP global version has been deleted.	RIP global version has been deleted.
RIP redistribute OSPF routes has been disabled.	RIP redistribute OSPF routes has been disabled.
RIP redistribute static routes has been disabled.	RIP redistribute static routes has been disabled.
RIP v2-broadcast on interface %s has been enabled.	RIP v2-broadcast on interface %s has been enabled. %s: Interface Name.
RIP send-version on interface %s has been changed to %s.	RIP send-version on interface %s has been changed to version 1 or 2 or both 1 2. %s: Interface Name.
RIP receive-version on interface %s has been changed to %s.	RIP receive-version on interface %s has been changed to version 1 or 2 or both 1 2. 2nd%s: Interface Name.
RIP send-version on interface %s has been reset to current global version %s.	RIP send-version on interface %s has been reset to current global version %s. 1st %s: Interface Name, 2nd %s: RIP Version
RIP receive-version on interface %s has been reset to current global version %s.	RIP receive-version on interface %s has been reset to current global version %s. 1st %s: Interface Name, 2nd %s: RIP
RIP v2-broadcast on interface %s has been disabled.	RIP v2-broadcast on interface %s has been disabled. %s: Interface Name
Area %s cannot be removed. This area is in use.	One or more interfaces are still using this area, so area %s cannot be removed. %s: OSPF Area

Table 255 Routing Protocol Logs (continued)

LOG MESSAGE	DESCRIPTION
Invalid OSPF %s authentication of area %s.	OSPF md5 or text authentication has been set without setting md5 authentication id and key, or text authentication key first.
Invalid OSPF virtual-link %d md5 authentication of area %s.	Virtual-link %s md5 authentication has been set without setting md5 authentication id and key first. %s: Virtual-Link ID
Invalid OSPF virtual-link %s text authentication of area %s.	Virtual-link %s text authentication has been set without setting text authentication key first. %s: Virtual-Link ID
Invalid OSPF virtual-link %s authentication of area %s.	Virtual-link %s authentication has been set to same-as-area but the area has invalid authentication configuration. %s: Virtual-Link ID
Invalid OSPF md5 authentication on interface %s.	Invalid OSPF md5 authentication is set on interface %s. %s: Interface Name
Invalid OSPF text authentication on interface %s.	Invalid OSPF text authentication is set on interface %s. %s: Interface Name
Interface %s does not belong to any OSPF area.	Interface %s has been set OSPF authentication same-as-area, however the interface does not belong to any OSPF area. %s: Interface Name
Invalid OSPF authentication of area %s on interface %s.	Interface %s has been set OSPF authentication same-as-area, however the area has invalid text authentication configuration. %s: Interface Name

Table 256 NAT Logs

LOG MESSAGE	DESCRIPTION
The NAT range is full	The NAT mapping table is full.
%s FTP ALG has succeeded.	The FTP Application Layer Gateway (ALG) has been turned on or off. %s: Enable or Disable
Extra signal port of FTP ALG has been modified.	Extra FTP ALG port has been changed.
Signal port of FTP ALG has been modified.	Default FTP ALG port has been changed.
%s H.323 ALG has succeeded.	The H.323 ALG has been turned on or off. %s: Enable or Disable
Extra signal port of H.323 ALG has been modified.	Extra H.323 ALG port has been changed.
Signal port of H.323 ALG has been modified.	Default H.323 ALG port has been changed.

Table 256 NAT Logs (continued)

LOG MESSAGE	DESCRIPTION
%s SIP ALG has succeeded.	The SIP ALG has been turned on or off. %s: Enable or Disable
Extra signal port of SIP ALG has been modified.	Extra SIP ALG port has been changed.
Signal port of SIP ALG has been modified.	Default SIP ALG port has been changed.
Register SIP ALG extra port=%d failed.	SIP ALG apply additional signal port failed. %d: Port number
Register SIP ALG signal port=%d failed.	SIP ALG apply signal port failed. %d: Port number
Register H.323 ALG extra port=%d failed.	H323 ALG apply additional signal port failed. %d: Port number
Register H.323 ALG signal port=%d failed.	H323 ALG apply signal port failed. %d: Port number
Register FTP ALG extra port=%d failed.	FTP ALG apply additional signal port failed. %d: Port number
Register FTP ALG signal port=%d failed.	FTP ALG apply signal port failed. %d: Port number

Table 257 PKI Logs

LOG MESSAGE	DESCRIPTION
Generate X509certificate "%s" successfully	The router created an X509 format certificate with the specified name.
Generate X509 certificate "%s" failed, errno %d	The router was not able to create an X509 format certificate with the specified name. See Table 282 on page 784 for details about the error number.
Generate certificate request "%s" successfully	The router created a certificate request with the specified name.
Generate certificate request "%s" failed, errno %d	The router was not able to create a certificate request with the specified name. See Table 282 on page 784 for details about the error number.
Generate PKCS#12 certificate "%s" successfully	The router created a PKCS#12 format certificate with the specified name.
Generate PKCS#12 certificate "%s" failed, errno %d	The router was not able to create anPKCS#12 format certificate with the specified name. See Table 282 on page 784 for details about the error number.

Table 257 PKI Logs (continued)

LOG MESSAGE	DESCRIPTION
Prepare to import "%s" into "My Certificate"	%s is the name of a certificate request.
Prepare to import "%s" into Trusted Certificate"	%s is the name of a certificate request.
CMP enrollment "%s" successfully, CA "%s", URL "%s"	The device used CMP to enroll a certificate. 1st %s is a request name, 2nd %s is the CA name, 3rd %s is the URL .
CMP enrollment "%s" failed, CA "%s", URL "%s"	The device was unable to use CMP to enroll a certificate. 1st %s is a request name, 2nd %s is the CA name, 3rd %s is the URL
SCEP enrollment "%s" successfully, CA "%s", URL "%s"	The device used SCEP to enroll a certificate. 1st %s is a request name, 2nd %s is the CA name, 3rd %s is the URL .
SCEP enrollment "%s" failed, CA "%s", URL "%s"	The device was unable to use SCEP to enroll a certificate. 1st %s is a request name, 2nd %s is the CA name, 3rd %s is the URL
Import X509 certificate "%s" into My Certificate successfully	The device imported a x509 format certificate into My Certificates. %s is the certificate request name.
Import X509 certificate "%s" into Trusted Certificate successfully	The device imported a x509 format certificate into Trusted Certificates. %s is the certificate request name.
Import PKCS#12 certificate "%s" into "My Certificate" successfully	The device imported a PKCS#12 format certificate into My Certificates. %s is the certificate request name.
Import PKCS#7 certificate "%s" into "My Certificate" successfully	The device imported a PKCS#7 format certificate into My Certificates. %s is the certificate request name.
Import PKCS#7 certificate "%s" into "Trusted Certificate" successfully	The device imported a PKCS#7 format certificate into Trusted Certificates. %s is the certificate request name.
Decode imported certificate "%s" failed	The device was not able to decode an imported certificate. %s is certificate the request name
Export PKCS#12 certificate "%s" from "My Certificate" successfully	The device exported a PKCS#12 format certificate from My Certificates. %s is the certificate request name.
Export PKCS#12 certificate "%s" from "My Certificate" failed	The device was not able to export a PKCS#12 format certificate from My Certificates. %s is the certificate request name.

Table 257 PKI Logs (continued)

LOG MESSAGE	DESCRIPTION
Export X509 certificate "%s" from "My Certificate" failed	The device was not able to export a x509 format certificate from My Certificates. %s is the certificate request name.
Export X509 certificate "%s" from "Trusted Certificate" failed	The device was not able to export a x509 format certificate from Trusted Certificates. %s is the certificate request name.
Export X509 certificate "%s" from "My Certificate" successfully	The device exported a x509 format certificate from My Certificates. %s is the certificate request name.
Export X509 certificate "%s" from "Trusted Certificate" successfully	The device exported a x509 format certificate from Trusted Certificates. %s is the certificate request name.
Export X509 certificate "%s" from "My Certificate" failed	The device was not able to export a x509 format certificate from My Certificates. %s is the certificate request name.
Import PKCS#12 certificate "%s" with incorrect password	An administrator used the wrong password when trying to import a PKCS#12 format certificate. %s is the certificate name.
Cert trusted: %s	%s is the subject.
Due to %d, cert not trusted: %s	%d is an error number (see Table 282 on page 784), %s is the certificate subject.

CODE	DESCRIPTION
1	Algorithm mismatch between the certificate and the search constraints.
2	Key usage mismatch between the certificate and the search constraints.
3	Certificate was not valid in the time interval.
4	(Not used)
5	Certificate is not valid.
6	Certificate signature was not verified correctly.
7	Certificate was revoked by a CRL.
8	Certificate was not added to the cache.
9	Certificate decoding failed.
10	Certificate was not found (anywhere).
11	Certificate chain looped (did not find trusted root).
12	Certificate contains critical extension that was not handled.
13	Certificate issuer was not valid (CA specific information missing).
14	(Not used)

CODE	DESCRIPTION
15	CRL is too old.
16	CRL is not valid.
17	CRL signature was not verified correctly.
18	CRL was not found (anywhere).
19	CRL was not added to the cache.
20	CRL decoding failed.
21	CRL is not currently valid, but in the future.
22	CRL contains duplicate serial numbers.
23	Time interval is not continuous.
24	Time information not available.
25	Database method failed due to timeout.
26	Database method failed.
27	Path was not verified.
28	Maximum path length reached.

Table 258 Interface Logs

LOG MESSAGE	DESCRIPTION
Interface %s has been deleted.	An administrator deleted an interface. %s is the interface name.
Create interface %s has been failed.	When PPP can't running fail, %s: interface name.
Base interface %s is disabled. Interface %s is disabled now.	When user disable ethernet, vlan or bridge interface and this interface is base interface of PPP or virtual interface. PPP and virtual will disable too. 1st %s is interface name, 2nd %s is interface.
Interface %s has been changed.	An administrator changed an interface's configuration. %s: interface name.
Interface %s has been added.	An administrator added a new interface. %s: interface name.
Interface %s is enabled.	An administrator enabled an interface. %s: interface name.
Interface %s is disabled.	An administrator disabled an interface. %s: interface name.
%s MTU > (%s MTU - 8), %s may not work correctly.	An administrator configured a PPP interface, PPP interface MTU > (base interface MTU - 8), PPP interface may not run correctly because PPP packets will be fragmented by base interface and the peer will not receive correct PPP packets. 1st %s: PPP interface name, 2nd %s: ethernet interface name.

Table 258 Interface Logs (continued)

LOG MESSAGE	DESCRIPTION
(%s MTU - 8) < %s MTU, %s may not work correctly.	An administrator configured ethernet, vlan or bridge and this interface is base interface of PPP interface. PPP interface MTU > (base interface MTU - 8), PPP interface may not run correctly because PPP packets will be fragmented by base interface and peer will not receive correct PPP packets.1st %s: Ethernet interface name, 2nd %s: PPP interface name.
Interface %s links down. Default route will not apply until interface %s links up.	An administrator set a static gateway in interface but this interface is link down. At this time the configuration will be saved but route will not take effect until the link becomes up.1st %s: interface name, 2nd %s: interface name.
name=%s,status=%s,TxPkts=%u,RxPkts=%u,Colli.=%u,TxB/s=%u,RxB/s=%u,UpTime=%s	Port statistics log. This log will be sent to the VRPT server. 1st %s: physical port name, 2nd %s: physical port status, 1st %u: physical port Tx packets, 2nd %u: physical port Rx packets, 3rd %u: physical port packets collisions, 4th %u: physical port Tx Bytes/s, 5th %u: physical port Rx Bytes/s, 3rd %s: physical port up time.
name=%s,status=%s,TxPkts=%u,RxPkts=%u,Colli.=%u,TxB/s=%u,RxB/s=%u	Interface statistics log. This log will be sent to the VRPT server. 1st %s: interface name, 2nd %s: interface status, 1st %u variable: interface Tx packets, 2nd %u variable: interface Rx packets, 3rd %u: interface packets collisions, 4th %u: interface Tx Bytes/s, 5th %u: interface Rx Bytes/s.
Interface %s start dialing.	A PPP interface started dialing to a server. %s: interface name.
Interface %s connect failed: Connect to server failed.	A PPTP interface failed to connect to the PPTP server. %s: interface name.
Interface %s connection terminated.	A PPP connection will terminate. %s: interface name.
Interface %s connection terminated: idle timeout.	An idle PPP connection timed out.1%s: interface name.
Interface %s connect failed: MS-CHAPv2 mutual authentication failed.	MS-CHAPv2 authentication failed (the server must support mS-CHAPv2 and verify that the authentication failed, this does not include cases where the servers does not support MS-CHAPv2). %s: interface name.
Interface %s connect failed: MS-CHAP authentication failed.	MS-CHAP authentication failed (the server must support MS-CHAP and verify that the authentication failed, this does not include cases where the server does not support MS-CHAP). %s: interface name.
Interface %s connect failed: CHAP authentication failed.	CHAP authentication failed (the server must support CHAP and verify that the authentication failed, this does not include cases where the server does not support CHAP). CHAP: interface name.
Interface %s is connected.	A PPP interface connected successfully. %s: interface name.

Table 258 Interface Logs (continued)

LOG MESSAGE	DESCRIPTION
Interface %s is disconnected.	A PPP interface disconnected successfully. %s: interface name.
Interface %s connect failed: Peer not responding.	The interface's connection will be terminated because the server did not send any LCP packets. %s: interface name.
Interface %s connect failed: PAP authentication failed.	PAP authentication failed (the server must support PAP and verify verify that the authentication failed, this does not include cases where the server does not support PAP). %s: PPP interface name.
Interface %s connect failed: Connect timeout.	A PPPOE connection timed out due to a lack of response from the PPPOE server. %s: PPP interface name.
Interface %s create failed because has no member.	A bridge interface has no member. %s: bridge interface name.
"Interface cellular Application Error Code %d\n.	The listed error code (%d) was generated due to an internal cellular interface error.
"An error [%d] occurred while negotiating with the device in %s. Please try to remove then insert the device.	The listed error code (%d) happened when the ZyWALL attempted to negotiate with the cellular device installed in (or connected to) the listed slot (%s). Remove and reinstall the device.
"Unable to negotiate with the device in %s. Please try to remove then insert the device.	The ZyWALL could not negotiate with the cellular device installed in (or connected to) the listed slot (%s). Remove and reinstall the device.
"Unable to configure the selected frequency band to the device in %s. Please try to remove then insert the device.	The ZyWALL failed to set the cellular device installed in (or connected to) the listed slot (%s) to use the frequency band you configured. The cellular device may not support the band or you may need to try removing and reinstalling the device.
"PIN code is required for interface cellular%d. Please check the PIN code setting.	The PIN code configured for the listed cellular interface (%d) is incorrect or missing.
"SIM card has been successfully unlocked by PUK code on interface cellular%d.	You entered the correct PUK code and unlocked the SIM card for the cellular device associated with the listed cellular interface (%d).
"Incorrect PUK code of interface cellular%d. Please check the PUK code setting.	You entered an incorrect PUK code so you were not able to unlock the SIM card for the cellular device associated with the listed cellular interface (%d).

Table 258 Interface Logs (continued)

LOG MESSAGE	DESCRIPTION
"SIM card of interface cellular%d in %s is damaged or not inserted. Please remove the device, then check the SIM card.	The SIM card for the cellular device associated with the listed cellular interface (%d) cannot be detected. The SIM card may be missing, not inserted properly, or damaged. Remove the device and check its SIM card. If it does not appear to be damaged, try re-inserting the SIM card.
"SIM card of interface cellular%d in %s is locked. Please enter PUK code to unlock.	The SIM card for the cellular device associated with the listed cellular interface (%d) is locked. This may be because the PIN code was entered incorrectly more than three times. You need to enter the PUK code to unlock the SIM card. .
"Incorrect PIN code of interface cellular%d. Please check the PIN code setting.	The listed cellular interface (%d) does has the wrong PIN code configured.
"Unable to query the signal quality from the device in %s. Please try to remove then insert the device.	The ZyWALL could not check the signal strength for the listed cellular interface (%d). This could be due to an error or being out of range of the ISP's cellular station.
"Interface cellular%d cannot connect to the service provider.	The listed cellular interface (%d) cannot connect to the ISP. This could be due to an error or being out of range of the ISP's cellular station.
"Interface cellular%d is configured with incorrect APN.	The listed cellular interface (%d) does not have the correct APN (Access Point Name) configured.
"Interface cellular%d is configured with incorrect phone number.	The listed cellular interface (%d) does not have the correct phone number configured.
"Interface cellular%d is configured with incorrect username or password.	The listed cellular interface (%d) does not have the correct user name and password configured.
"Interface cellular%d is configured with device %s, but current inserted device is %s.	The listed cellular interface (%d) is configured for a particular cellular device (first %s), but a different cellular device (second %s) is inserted.
"Cellular device [%s %s] has been inserted into %s.	The cellular device (identified by its manufacturer and model) has been inserted in or connected to the specified slot.
"Cellular device [%s %s] has been removed from %s.	The cellular device (identified by its manufacturer and model) has been removed from the specified slot.

Table 258 Interface Logs (continued)

LOG MESSAGE	DESCRIPTION
Interface cellular%d required authentication password.Please set password in cellular%d edit page.	You need to manually enter the password for the listed cellular interface (%d).
"Cellular%d (IMSI=%s or ESN=%s) over time budget!(budget = %d seconds).	The listed cellular interface (%d) with the listed SIM card IMSI number or IMEI/ESN number went over the listed time budget threshold value (second %d).
"Cellular%d (IMSI=%s or ESN=%s) over time budget %d%% (budget = %d seconds).	The listed cellular interface (%d) with the listed SIM card IMSI number or IMEI/ESN number went over the listed percentage of the time budget threshold value (second %d).
"Cellular%d (IMSI=%s or ESN=%s) over time budget!(budget = %d seconds).	This alert lets you know that the listed cellular interface (%d) with the listed SIM card IMSI number or IMEI/ESN number went over the listed time budget threshold value (second %d).
"Cellular%d (IMSI=%s or ESN=%s) over time budget %d%% (budget = %d seconds).	This alert lets you know that the listed cellular interface (%d) with the listed SIM card IMSI number or IMEI/ESN number went over the listed percentage of the time budget threshold value (second %d).
"Cellular%d (IMSI=%s or ESN=%s) over data budget!(budget = %lld Mbytes, used = %lld Mbytes).	The listed cellular interface (%d) with the listed SIM card IMSI number or IMEI/ESN number went over the listed data budget by the listed number of MB.
"Cellular%d (IMSI=%s or ESN=%s) over data budget %d%% (budget = %.2f Mbytes, used = %.2f Mbytes).	The listed cellular interface (%d) with the listed SIM card IMSI number or IMEI/ESN number went over the listed percentage of the data budget threshold value.
"Cellular%d (IMSI=%s or ESN=%s) over data budget!(budget = %lld Mbytes, used = %lld Mbytes).	This alert lets you know that the listed cellular interface (%d) with the listed SIM card IMSI number or IMEI/ESN number went over the listed data budget by the listed number of MB.
"Cellular%d (IMSI=%s or ESN=%s) over data budget %d%% (budget = %.2f Mbytes, used = %.2f Mbytes).	This alert lets you know that the listed cellular interface (%d) with the listed SIM card IMSI number or IMEI/ESN number went over the listed percentage of the data budget threshold value.
The interface name is not accepted.	An incorrect name was not permitted for an interface.
Configured interface name is reserved word.	A reserved word was not permitted to be used in an interface name.
Configured interface name match reserved prefix.	A reserved pre-fix was not permitted to be used in an interface name.

Table 258 Interface Logs (continued)

LOG MESSAGE	DESCRIPTION
Duplicated interface name.	A duplicate name was not permitted for an interface.
This Interface can not be renamed.	An interface's name cannot be changed.
Virtual interface is not supported on this type of interface.	A virtual interface was not created on an interface because the type of interface does not support virtual interfaces.
Virtual interface need to be removed before changing the interface property.	An interface property cannot be changed because the interface has a virtual interface on it.
Virtual interface can not configured at external interface.	A virtual interface cannot be configured on an external interface.
Interface property is not accepted.	An invalid interface property was not accepted.
The property can not be changed at this interface.	An interface property cannot be changed.
System default ppp interface can not bind with other ethernet interface.	The system default PPP interface can only be bound with the corresponding Ethernet interface, not any other.
Related system default ppp interface need to deactivate first.	The related system default PPP interface has to be deactivated before the attempted configuration can be done.
Related system default ppp interface can not be activated since interface property is internal.	The system default PPP interface cannot be activated because it is related to an internal interface.
System default ppp interface can not be removed.	A PPP interface could not be removed because it is a system default PPP interface.
Interface property can not change to internal since interface is the member of other trunk.	An interface can not be set to be an internal interface because it is a member of a trunk.
Port-grouping is not support	The interface does not support port grouping.
This interface type can not set 3rd-dns.	This type of interface does not support setting a third DNS server setting.

Table 258 Interface Logs (continued)

LOG MESSAGE	DESCRIPTION
name=%s,status=%s,TxPkts=%u,RxPkts=%u,Colli.=%u,TxB/s=%u,RxB/s=%u,UpTime=%s	This log is sent to the VRPT server to show the specified PPP/Cellular interface's statistics and uptime. The arguments represent the interface name, interface status, interface Tx packets, interface Rx packets, interface collision packets, interface Tx Bytes/s, interface Rx Bytes/s, and interface up time.
Interface %s has been renamed from '%s' to '%s'	The user-configurable name of the specified interface (internal system name) has been renamed from one name to another.

Table 259 WLAN Logs

LOG MESSAGE	DESCRIPTION
Wlan %s is enabled.	The WLAN (IEEE 802.11 b and or g) feature has been turned on. %s is the slot number where the WLAN card is or can be installed.
Wlan %s is disabled.	The WLAN (IEEE 802.11 b and or g) feature has been turned off. %s is the slot number where the WLAN card is or can be installed.
Wlan %s has been configured.	The WLAN (IEEE 802.11 b and or g) feature's configuration has been changed. %s is the slot number where the WLAN card is or can be installed.
Interface %s has been configured.	The configuration of the specified WLAN interface (%s) has been changed.
Interface %s has been deleted.	The specified WLAN interface (%s) has been removed.
Create interface %s has failed. Wlan device does not exist.	The wireless device failed to create the specified WLAN interface (%s). Remove the wireless device and reinstall it.
System internal error. No 802.1X or WPA enabled!	IEEE 802.1x or WPA is not enabled.
System internal error. Error configuring WPA state!	The ZyWALL was not able to configure the wireless device to use WPA. Remove the wireless device and reinstall it.
System internal error. Error enabling WPA/802.1X!	The ZyWALL was not able to enable WPA/IEEE 802.1X.
Station has associated. Interface: %s, MAC: %s.	A wireless client with the specified MAC address (second %s) associated with the specified WLAN interface (first %s).
WPA or WPA2 enterprise EAP timeout. Interface: %s, MAC: %s.	There was an EAP timeout for a wireless client connected to the specified WLAN interface (first %s). The MAC address of the wireless client is listed (second %s).

Table 259 WLAN Logs (continued)

LOG MESSAGE	DESCRIPTION
Station association has failed. Maximum associations have reached the maximum number. Interface: %s, MAC: %s.	A wireless client with the specified MAC address (second %s) failed to connect to the specified WLAN interface (first %s) because the WLAN interface already has its maximum number of wireless clients.
WPA authentication has failed. Interface: %s, MAC: %s.	A wireless client used an incorrect WPA key and thus failed to connect to the specified WLAN interface (first %s). The MAC address of the wireless client is listed (second %s).
Incorrect password for WPA or WPA2 enterprise internal authentication. Interface: %s, MAC: %s.	A wireless client used an incorrect WPA or WPA2 user password and failed authentication by the ZyWALL's local user database while trying to connect to the specified WLAN interface (first %s). The MAC address of the wireless client is listed (second %s).
Incorrect username or password for WPA or WPA2 enterprise internal authentication. Interface: %s, MAC: %s.	A wireless client used an incorrect WPA or WPA2 user name or user password and failed authentication by the ZyWALL's local user database while trying to connect to the specified WLAN interface (first %s). The MAC address of the wireless client is listed (second %s).
System internal error. %s: STA %s could not extract EAP-Message from RADIUS message	There was an error when attempting to extract the EAP-Message from a RADIUS message. The first %s is the WLAN interface. The second %s is the MAC address of the wireless client.

Table 260 Account Logs

LOG MESSAGE	DESCRIPTION
Account %s %s has been deleted.	A user deleted an ISP account profile. 1st %s: profile type, 2nd %s: profile name.
Account %s %s has been changed.	A user changed an ISP account profile's options. 1st %s: profile type, 2nd %s: profile name.
Account %s %s has been added.	A user added a new ISP account profile. 1st %s: profile type, 2nd %s: profile name.

Table 261 Port Grouping Logs

LOG MESSAGE	DESCRIPTION
Interface %s links up because of changing Port Group. Enable DHCP client.	An administrator used port-grouping to assign a port to a representative Interface and this representative interface is set to DHCP client and only has one member. In this case the DHCP client will be enabled. %s: interface name.
Interface %s links down because of changing Port Group. Disable DHCP client.	An administrator used port-grouping to assign a port to a representative interface and this representative interface is set to DHCP client and has no members in its group. In this case the DHCP client will be disabled. %s: interface name.
Port Group on %s is changed. Renew DHCP client.	An administrator used port-grouping to assign a port to a representative interface and this representative interface is set to DHCP client and has more than one member in its group. In this case the DHCP client will renew. %s: interface name.
Port Grouping %s has been changed.	An administrator configured port-grouping, %s: interface name.

Table 262 Force Authentication Logs

LOG MESSAGE	DESCRIPTION
Force User Authentication will be enabled due to http server is enabled.	Force user authentication will be turned on because HTTP server was turned on.
Force User Authentication will be disabled due to http server is disabled.	Force user authentication will be turned off because HTTP server was turned off.
Force User Authentication may not work properly!	

Table 263 File Manager Logs

LOG MESSAGE	DESCRIPTION
ERROR:#%s, %s	Apply configuration failed, this log will be what CLI command is and what error message is. 1st %s is CLI command. 2nd %s is error message when apply CLI command.
WARNING:#%s, %s	Apply configuration failed, this log will be what CLI command is and what warning message is. 1st %s is CLI command. 2nd %s is warning message when apply CLI command.

Table 263 File Manager Logs (continued)

LOG MESSAGE	DESCRIPTION
ERROR:##%s, %s	Run script failed, this log will be what wrong CLI command is and what error message is. 1st %s is CLI command. 2nd %s is error message when apply CLI command.
WARNING:##%s, %s	Run script failed, this log will be what wrong CLI command is and what warning message is. 1st %s is CLI command. 2nd %s is warning message when apply CLI command.
Resetting system...	Before apply configuration file.
System reseted. Now apply %s..	After the system reset, it started to apply the configuration file. %s is configuration file name.
Running %s...	An administrator ran the listed shell script. %s is script file name.
Going to rollback previous running-config.	Applying the configuration file failed and the ZyWALL is going to roll back to the previous running-config.

Table 264 DHCP Logs

LOG MESSAGE	DESCRIPTION
Can't find any lease for this client - %s, DHCP pool full!	All of the IP addresses in the DHCP pool are already assigned to DHCP clients, so there is no IP address to give to the listed DHCP client.
DHCP server offered %s to %s(%s)	The DHCP server feature gave the listed IP address to the computer with the listed hostname and MAC address.
Requested %s from %s(%s)	The ZyWALL received a DHCP request for the specified IP address from the computer with the listed hostname and MAC address.
No applicable lease found for DHCP request - %s !	There is no matching DHCP lease for a DHCP client's request for the specified IP address.
DHCP released %s with %s(%s)	A DHCP client released the specified IP address. The DHCP client's hostname and MAC address are listed.
Sending ACK to %s	The DHCP server feature received a DHCP client's inform packet and is sending an ACK to the client.
DHCP server assigned %s to %s(%s)	The DHCP server feature assigned a client the IP address that it requested. The DHCP client's hostname and MAC address are listed.

Table 265 E-mail Daily Report Logs

LOG MESSAGE	DESCRIPTION
Email Daily Report has been activated.	The daily e-mail report function has been turned on. The ZyWALL will e-mail a daily report about the selected items at the scheduled time if the required settings are configured correctly.
Email Daily Report has been deactivated.	The daily e-mail report function has been turned off. The ZyWALL will not e-mail daily reports.
Email daily report has been sent successfully.	The ZyWALL sent a daily e-mail report mail successfully.
Cannot resolve mail server address %s.	The (listed) SMTP address configured for the daily e-mail report function is incorrect.
Mail server authentication failed.	The user name or password configured for authenticating with the e-mail server is incorrect.
Failed to send report. Mail From address %s1 is inconsistent with SMTP account %s2.	The user name and password configured for authenticating with the e-mail server are correct, but the (listed) sender e-mail address does not match the (listed) SMTP e-mail account.
Failed to connect to mail server %s.	The ZyWALL could not connect to the SMTP e-mail server (%s). The address configured for the server may be incorrect or there may be a problem with the ZyWALL's or the server's network connection.

Table 266 IP-MAC Binding Logs

LOG MESSAGE	DESCRIPTION
Drop packet %s-%u.%u.%u.%u-%02X:%02X:%02X:%02X:%02X:%02X	The IP-MAC binding feature dropped an Ethernet packet. The interface the packet came in through and the sender's IP address and MAC address are also shown.
Cannot bind ip-mac from dhcpd: %s#%u.%u.%u.%u#%02X:%02X:%02X:%02X:%02X:%02X.	The IP-MAC binding feature could not create an IP-MAC binding hash table entry. The interface the packet came in through, the sender's IP address and MAC address, are also shown along with the binding type ("s" for static or "d" for dynamic).
Cannot remove ip-mac binding from dhcpd: %s#%u.%u.%u.%u#%02X:%02X:%02X:%02X:%02X:%02X.	The IP-MAC binding feature could not delete an IP-MAC binding hash table entry. The interface the packet came in through, the sender's IP address and MAC address, are also shown along with the binding type ("s" for static or "d" for dynamic).

Table 267 Auth. Policy Logs

LOG MESSAGE	DESCRIPTION
Auth. Policy featurer is disabled.	The auth. policy feature is not enabled.
Auth. policy %d is disabled.	The specified auth. policy rule is not activated.
System integrity error!	The ZyWALL cannot get the auth. policy rule and related operation index.
Get lock id has failed	Cannot get semaphore locked ID.
Lock buffer id has failed	Cannot use the current semaphore related buffer.
The Auth. policy %d has been changed 'EPS' value.	The EPS object of the specified Auth. policy has changed.
EPS' signature data of Auth. policy %d has been updated.	The EPS object used by the specified Auth. policy was updated.

Table 268 EPS Logs

LOG MESSAGE	DESCRIPTION
Windows service pack check fail in %s	The Windows service pack on a user's computer did not match the specified EPS object.
Windows auto update check fail in %s	The Windows automatic update setting on a user's computer did not match the specified EPS object.
Windows security patch check fail in %s	The Windows security patch on a user's computer did not match the specified EPS object.
Personal firewall check fail in %s	A user's computer did not match the personal firewall software check in the specified EPS object.
Windows registry check fail in %s	A user's computer did not match the registry check in the specified EPS object.
Trusted process check fail in %s	A user's computer did not match the user-defined trusted process check in the specified EPS object.
Forbidden process check fail in %s	A user's computer did not match the user-defined forbidden process check in the specified EPS object.
Files information check fail in %s	A user's computer did not match the user-defined file information check in the specified EPS object.
OS type check fail in %s	A user's computer did not match the OS type check in the specified EPS object.

Table 268 EPS Logs

LOG MESSAGE	DESCRIPTION
Windows version check fail in %s	A user's computer did not match the Windows version check in the specified EPS object.
EPS checking result is pass.	A user's computer passed the EPS check.

Common Services

The following table lists some commonly-used services and their associated protocols and port numbers. For a comprehensive list of port numbers, ICMP type/code numbers and services, visit the IANA (Internet Assigned Number Authority) web site.

- **Name:** This is a short, descriptive name for the service. You can use this one or create a different one, if you like.
- **Protocol:** This is the type of IP protocol used by the service. If this is **TCP/UDP**, then the service uses the same port number with TCP and UDP. If this is **USER-DEFINED**, the **Port(s)** is the IP protocol number, not the port number.
- **Port(s):** This value depends on the **Protocol**. Please refer to RFC 1700 for further information about port numbers.
 - If the **Protocol** is **TCP, UDP, or TCP/UDP**, this is the IP port number.
 - If the **Protocol** is **USER**, this is the IP protocol number.
- **Description:** This is a brief explanation of the applications that use this service or the situations in which this service is used.

Table 269 Commonly Used Services

NAME	PROTOCOL	PORT(S)	DESCRIPTION
AH (IPSEC_TUNNEL)	User-Defined	51	The IPSEC AH (Authentication Header) tunneling protocol uses this service.
AIM/New-ICQ	TCP	5190	AOL's Internet Messenger service. It is also used as a listening port by ICQ.
AUTH	TCP	113	Authentication protocol used by some servers.
BGP	TCP	179	Border Gateway Protocol.
BOOTP_CLIENT	UDP	68	DHCP Client.
BOOTP_SERVER	UDP	67	DHCP Server.
CU-SEEME	TCP UDP	7648 24032	A popular videoconferencing solution from White Pines Software.
DNS	TCP/UDP	53	Domain Name Server, a service that matches web names (for example www.zyxel.com) to IP numbers.

Table 269 Commonly Used Services (continued)

NAME	PROTOCOL	PORT(S)	DESCRIPTION
ESP (IPSEC_TUNNEL)	User-Defined	50	The IPSEC ESP (Encapsulation Security Protocol) tunneling protocol uses this service.
FINGER	TCP	79	Finger is a UNIX or Internet related command that can be used to find out if a user is logged on.
FTP	TCP TCP	20 21	File Transfer Program, a program to enable fast transfer of files, including large files that may not be possible by e-mail.
H.323	TCP	1720	NetMeeting uses this protocol.
HTTP	TCP	80	Hyper Text Transfer Protocol - a client/server protocol for the world wide web.
HTTPS	TCP	443	HTTPS is a secured http session often used in e-commerce.
ICMP	User-Defined	1	Internet Control Message Protocol is often used for diagnostic or routing purposes.
ICQ	UDP	4000	This is a popular Internet chat program.
IGMP (MULTICAST)	User-Defined	2	Internet Group Management Protocol is used when sending packets to a specific group of hosts.
IKE	UDP	500	The Internet Key Exchange algorithm is used for key distribution and management.
IRC	TCP/UDP	6667	This is another popular Internet chat program.
MSN Messenger	TCP	1863	Microsoft Networks' messenger service uses this protocol.
NEW-ICQ	TCP	5190	An Internet chat program.
NEWS	TCP	144	A protocol for news groups.
NFS	UDP	2049	Network File System - NFS is a client/server distributed file service that provides transparent file sharing for network environments.
NNTP	TCP	119	Network News Transport Protocol is the delivery mechanism for the USENET newsgroup service.
PING	User-Defined	1	Packet INTERNet Groper is a protocol that sends out ICMP echo requests to test whether or not a remote host is reachable.
POP3	TCP	110	Post Office Protocol version 3 lets a client computer get e-mail from a POP3 server through a temporary connection (TCP/IP or other).

Table 269 Commonly Used Services (continued)

NAME	PROTOCOL	PORT(S)	DESCRIPTION
PPTP	TCP	1723	Point-to-Point Tunneling Protocol enables secure transfer of data over public networks. This is the control channel.
PPTP_TUNNEL (GRE)	User-Defined	47	PPTP (Point-to-Point Tunneling Protocol) enables secure transfer of data over public networks. This is the data channel.
RCMD	TCP	512	Remote Command Service.
REAL_AUDIO	TCP	7070	A streaming audio service that enables real time sound over the web.
REXEC	TCP	514	Remote Execution Daemon.
RLOGIN	TCP	513	Remote Login.
RTELNET	TCP	107	Remote Telnet.
RTSP	TCP/UDP	554	The Real Time Streaming (media control) Protocol (RTSP) is a remote control for multimedia on the Internet.
SFTP	TCP	115	Simple File Transfer Protocol.
SMTP	TCP	25	Simple Mail Transfer Protocol is the message-exchange standard for the Internet. SMTP enables you to move messages from one e-mail server to another.
SNMP	TCP/UDP	161	Simple Network Management Program.
SNMP-TRAPS	TCP/UDP	162	Traps for use with the SNMP (RFC:1215).
SQL-NET	TCP	1521	Structured Query Language is an interface to access data on many different types of database systems, including mainframes, midrange systems, UNIX systems and network servers.
SSH	TCP/UDP	22	Secure Shell Remote Login Program.
STRM WORKS	UDP	1558	Stream Works Protocol.
SYSLOG	UDP	514	Syslog allows you to send system logs to a UNIX server.
TACACS	UDP	49	Login Host Protocol used for (Terminal Access Controller Access Control System).
TELNET	TCP	23	Telnet is the login and terminal emulation protocol common on the Internet and in UNIX environments. It operates over TCP/IP networks. Its primary function is to allow users to log into remote host systems.

Table 269 Commonly Used Services (continued)

NAME	PROTOCOL	PORT(S)	DESCRIPTION
TFTP	UDP	69	Trivial File Transfer Protocol is an Internet file transfer protocol similar to FTP, but uses the UDP (User Datagram Protocol) rather than TCP (Transmission Control Protocol).
VDOLIVE	TCP	7000	Another videoconferencing solution.

Wireless LANs

Wireless LAN Topologies

This section discusses ad-hoc and infrastructure wireless LAN topologies.

Ad-hoc Wireless LAN Configuration

The simplest WLAN configuration is an independent (Ad-hoc) WLAN that connects a set of computers with wireless adapters (A, B, C). Any time two or more wireless adapters are within range of each other, they can set up an independent network, which is commonly referred to as an ad-hoc network or Independent Basic Service Set (IBSS). The following diagram shows an example of notebook computers using wireless adapters to form an ad-hoc wireless LAN.

Figure 449 Peer-to-Peer Communication in an Ad-hoc Network



BSS

A Basic Service Set (BSS) exists when all communications between wireless clients or between a wireless client and a wired network client go through one access point (AP).

Intra-BSS traffic is traffic between wireless clients in the BSS. When Intra-BSS is enabled, wireless client **A** and **B** can access the wired network and communicate

with each other. When Intra-BSS is disabled, wireless client **A** and **B** can still access the wired network but cannot communicate with each other.

Figure 450 Basic Service Set

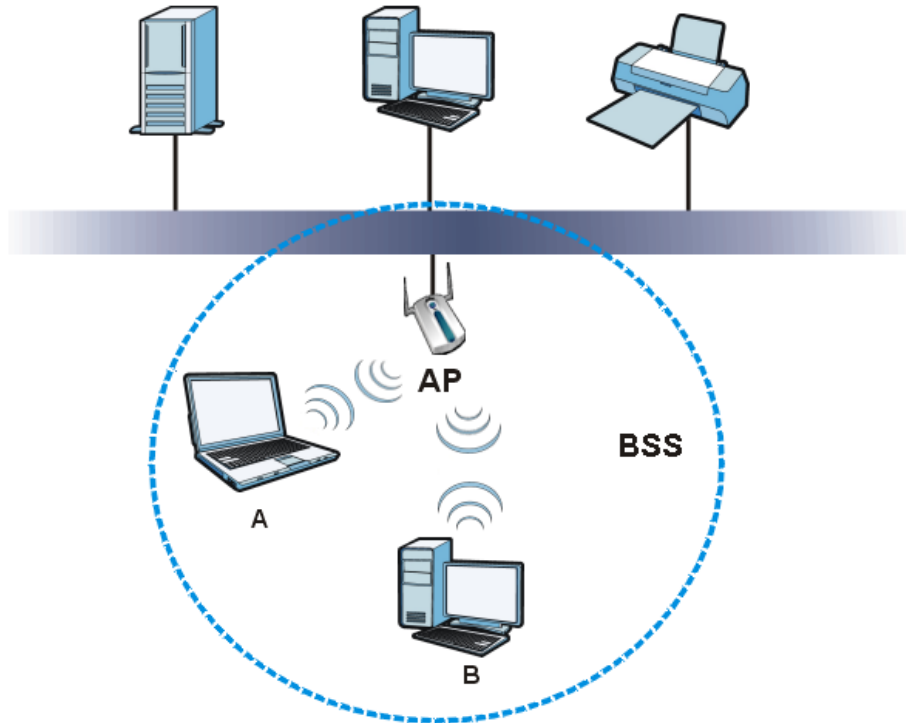

ESS

An Extended Service Set (ESS) consists of a series of overlapping BSSs, each containing an access point, with each access point connected together by a wired network. This wired connection between APs is called a Distribution System (DS).

This type of wireless LAN topology is called an Infrastructure WLAN. The Access Points not only provide communication with the wired network but also mediate wireless network traffic in the immediate neighborhood.

An ESSID (ESS IDentification) uniquely identifies each ESS. All access points and their associated wireless clients within the same ESS must have the same ESSID in order to communicate.

Figure 451 Infrastructure WLAN

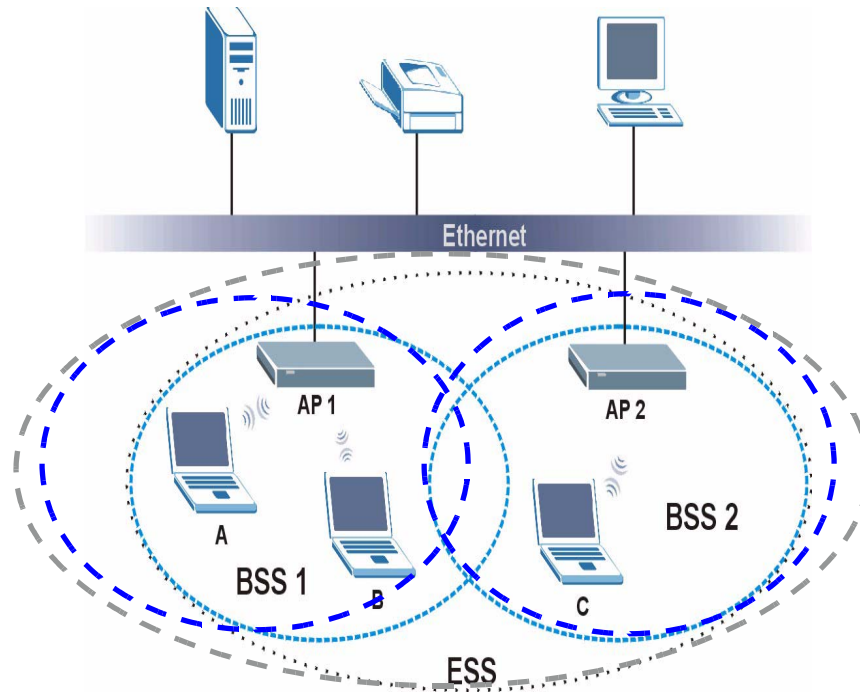

Channel

A channel is the radio frequency(ies) used by wireless devices to transmit and receive data. Channels available depend on your geographical area. You may have a choice of channels (for your region) so you should use a channel different from an adjacent AP (access point) to reduce interference. Interference occurs when radio signals from different access points overlap causing interference and degrading performance.

Adjacent channels partially overlap however. To avoid interference due to overlap, your AP should be on a channel at least five channels away from a channel that an adjacent AP is using. For example, if your region has 11 channels and an adjacent AP is using channel 1, then you need to select a channel between 6 or 11.

RTS/CTS

A hidden node occurs when two stations are within range of the same access point, but are not within range of each other. The following figure illustrates a hidden node. Both stations (STA) are within range of the access point (AP) or

wireless gateway, but out-of-range of each other, so they cannot "hear" each other, that is they do not know if the channel is currently being used. Therefore, they are considered hidden from each other.

Figure 452 RTS/CTS

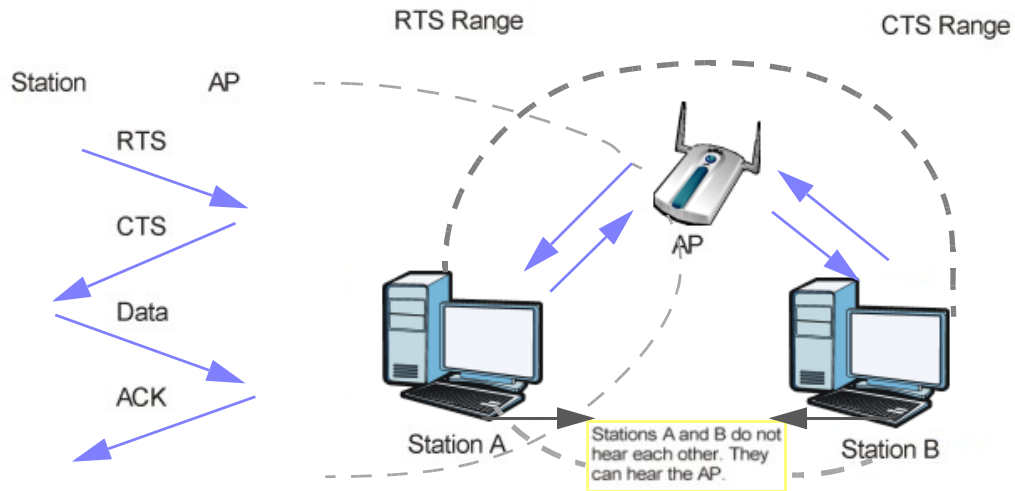

When station **A** sends data to the AP, it might not know that the station **B** is already using the channel. If these two stations send data at the same time, collisions may occur when both sets of data arrive at the AP at the same time, resulting in a loss of messages for both stations.

RTS/CTS is designed to prevent collisions due to hidden nodes. An **RTS/CTS** defines the biggest size data frame you can send before an RTS (Request To Send)/CTS (Clear to Send) handshake is invoked.

When a data frame exceeds the **RTS/CTS** value you set (between 0 to 2432 bytes), the station that wants to transmit this frame must first send an RTS (Request To Send) message to the AP for permission to send it. The AP then responds with a CTS (Clear to Send) message to all other stations within its range to notify them to defer their transmission. It also reserves and confirms with the requesting station the time frame for the requested transmission.

Stations can send frames smaller than the specified **RTS/CTS** directly to the AP without the RTS (Request To Send)/CTS (Clear to Send) handshake.

You should only configure **RTS/CTS** if the possibility of hidden nodes exists on your network and the "cost" of resending large frames is more than the extra network overhead involved in the RTS (Request To Send)/CTS (Clear to Send) handshake.

If the **RTS/CTS** value is greater than the **Fragmentation Threshold** value (see next), then the RTS (Request To Send)/CTS (Clear to Send) handshake will never occur as data frames will be fragmented before they reach **RTS/CTS** size.

Note: Enabling the RTS Threshold causes redundant network overhead that could negatively affect the throughput performance instead of providing a remedy.

Fragmentation Threshold

A **Fragmentation Threshold** is the maximum data fragment size (between 256 and 2432 bytes) that can be sent in the wireless network before the AP will fragment the packet into smaller data frames.

A large **Fragmentation Threshold** is recommended for networks not prone to interference while you should set a smaller threshold for busy networks or networks that are prone to interference.

If the **Fragmentation Threshold** value is smaller than the **RTS/CTS** value (see previously) you set then the RTS (Request To Send)/CTS (Clear to Send) handshake will never occur as data frames will be fragmented before they reach **RTS/CTS** size.

Preamble Type

Preamble is used to signal that data is coming to the receiver. Short and long refer to the length of the synchronization field in a packet.

Short preamble increases performance as less time sending preamble means more time for sending data. All IEEE 802.11 compliant wireless adapters support long preamble, but not all support short preamble.

Use long preamble if you are unsure what preamble mode other wireless devices on the network support, and to provide more reliable communications in busy wireless networks.

Use short preamble if you are sure all wireless devices on the network support it, and to provide more efficient communications.

Use the dynamic setting to automatically use short preamble when all wireless devices on the network support it, otherwise the ZyWALL uses long preamble.

Note: The wireless devices **MUST** use the same preamble mode in order to communicate.

IEEE 802.11g Wireless LAN

IEEE 802.11g is fully compatible with the IEEE 802.11b standard. This means an IEEE 802.11b adapter can interface directly with an IEEE 802.11g access point

(and vice versa) at 11 Mbps or lower depending on range. IEEE 802.11g has several intermediate rate steps between the maximum and minimum data rates. The IEEE 802.11g data rate and modulation are as follows:

Table 270 IEEE 802.11g

DATA RATE (MBPS)	MODULATION
1	DBPSK (Differential Binary Phase Shift Keyed)
2	DQPSK (Differential Quadrature Phase Shift Keying)
5.5 / 11	CCK (Complementary Code Keying)
6/9/12/18/24/36/48/54	OFDM (Orthogonal Frequency Division Multiplexing)

Wireless Security Overview

Wireless security is vital to your network to protect wireless communication between wireless clients, access points and the wired network.

Wireless security methods available on the ZyWALL are data encryption, wireless client authentication, restricting access by device MAC address and hiding the ZyWALL identity.

The following figure shows the relative effectiveness of these wireless security methods available on your ZyWALL.

Table 271 Wireless Security Levels

SECURITY LEVEL	SECURITY TYPE
Least Secure	Unique SSID (Default)
	Unique SSID with Hide SSID Enabled
	MAC Address Filtering
	WEP Encryption
	IEEE802.1x EAP with RADIUS Server Authentication
	Wi-Fi Protected Access (WPA)
Most Secure	WPA2

Note: You must enable the same wireless security settings on the ZyWALL and on all wireless clients that you want to associate with it.

IEEE 802.1x

In June 2001, the IEEE 802.1x standard was designed to extend the features of IEEE 802.11 to support extended authentication as well as providing additional

accounting and control features. It is supported by Windows XP and a number of network devices. Some advantages of IEEE 802.1x are:

- User based identification that allows for roaming.
- Support for RADIUS (Remote Authentication Dial In User Service, RFC 2138, 2139) for centralized user profile and accounting management on a network RADIUS server.
- Support for EAP (Extensible Authentication Protocol, RFC 2486) that allows additional authentication methods to be deployed with no changes to the access point or the wireless clients.

RADIUS

RADIUS is based on a client-server model that supports authentication, authorization and accounting. The access point is the client and the server is the RADIUS server. The RADIUS server handles the following tasks:

- Authentication
Determines the identity of the users.
- Authorization
Determines the network services available to authenticated users once they are connected to the network.
- Accounting
Keeps track of the client's network activity.

RADIUS is a simple package exchange in which your AP acts as a message relay between the wireless client and the network RADIUS server.

Types of RADIUS Messages

The following types of RADIUS messages are exchanged between the access point and the RADIUS server for user authentication:

- Access-Request
Sent by an access point requesting authentication.
- Access-Reject
Sent by a RADIUS server rejecting access.
- Access-Accept
Sent by a RADIUS server allowing access.
- Access-Challenge
Sent by a RADIUS server requesting more information in order to allow access. The access point sends a proper response from the user and then sends another Access-Request message.

The following types of RADIUS messages are exchanged between the access point and the RADIUS server for user accounting:

- Accounting-Request
Sent by the access point requesting accounting.
- Accounting-Response
Sent by the RADIUS server to indicate that it has started or stopped accounting.

In order to ensure network security, the access point and the RADIUS server use a shared secret key, which is a password, they both know. The key is not sent over the network. In addition to the shared key, password information exchanged is also encrypted to protect the network from unauthorized access.

Types of EAP Authentication

This section discusses some popular authentication types: EAP-MD5, EAP-TLS, EAP-TTLS, PEAP and LEAP. Your wireless LAN device may not support all authentication types.

EAP (Extensible Authentication Protocol) is an authentication protocol that runs on top of the IEEE 802.1x transport mechanism in order to support multiple types of user authentication. By using EAP to interact with an EAP-compatible RADIUS server, an access point helps a wireless station and a RADIUS server perform authentication.

The type of authentication you use depends on the RADIUS server and an intermediary AP(s) that supports IEEE 802.1x. .

For EAP-TLS authentication type, you must first have a wired connection to the network and obtain the certificate(s) from a certificate authority (CA). A certificate (also called digital IDs) can be used to authenticate users and a CA issues certificates and guarantees the identity of each certificate owner.

EAP-MD5 (Message-Digest Algorithm 5)

MD5 authentication is the simplest one-way authentication method. The authentication server sends a challenge to the wireless client. The wireless client 'proves' that it knows the password by encrypting the password with the challenge and sends back the information. Password is not sent in plain text.

However, MD5 authentication has some weaknesses. Since the authentication server needs to get the plaintext passwords, the passwords must be stored. Thus someone other than the authentication server may access the password file. In addition, it is possible to impersonate an authentication server as MD5 authentication method does not perform mutual authentication. Finally, MD5

authentication method does not support data encryption with dynamic session key. You must configure WEP encryption keys for data encryption.

EAP-TLS (Transport Layer Security)

With EAP-TLS, digital certifications are needed by both the server and the wireless clients for mutual authentication. The server presents a certificate to the client. After validating the identity of the server, the client sends a different certificate to the server. The exchange of certificates is done in the open before a secured tunnel is created. This makes user identity vulnerable to passive attacks. A digital certificate is an electronic ID card that authenticates the sender's identity. However, to implement EAP-TLS, you need a Certificate Authority (CA) to handle certificates, which imposes a management overhead.

EAP-TTLS (Tunneled Transport Layer Service)

EAP-TTLS is an extension of the EAP-TLS authentication that uses certificates for only the server-side authentications to establish a secure connection. Client authentication is then done by sending username and password through the secure connection, thus client identity is protected. For client authentication, EAP-TTLS supports EAP methods and legacy authentication methods such as PAP, CHAP, MS-CHAP and MS-CHAP v2.

PEAP (Protected EAP)

Like EAP-TTLS, server-side certificate authentication is used to establish a secure connection, then use simple username and password methods through the secured connection to authenticate the clients, thus hiding client identity. However, PEAP only supports EAP methods, such as EAP-MD5, EAP-MSCHAPv2 and EAP-GTC (EAP-Generic Token Card), for client authentication. EAP-GTC is implemented only by Cisco.

LEAP

LEAP (Lightweight Extensible Authentication Protocol) is a Cisco implementation of IEEE 802.1x.

Dynamic WEP Key Exchange

The AP maps a unique key that is generated with the RADIUS server. This key expires when the wireless connection times out, disconnects or reauthentication times out. A new WEP key is generated each time reauthentication is performed.

If this feature is enabled, it is not necessary to configure a default encryption key in the wireless security configuration screen. You may still configure and store keys, but they will not be used while dynamic WEP is enabled.

Note: EAP-MD5 cannot be used with Dynamic WEP Key Exchange

For added security, certificate-based authentications (EAP-TLS, EAP-TTLS and PEAP) use dynamic keys for data encryption. They are often deployed in corporate environments, but for public deployment, a simple user name and password pair is more practical. The following table is a comparison of the features of authentication types.

Table 272 Comparison of EAP Authentication Types

	EAP-MD5	EAP-TLS	EAP-TTLS	PEAP	LEAP
Mutual Authentication	No	Yes	Yes	Yes	Yes
Certificate – Client	No	Yes	Optional	Optional	No
Certificate – Server	No	Yes	Yes	Yes	No
Dynamic Key Exchange	No	Yes	Yes	Yes	Yes
Credential Integrity	None	Strong	Strong	Strong	Moderate
Deployment Difficulty	Easy	Hard	Moderate	Moderate	Moderate
Client Identity Protection	No	No	Yes	Yes	No

WPA and WPA2

Wi-Fi Protected Access (WPA) is a subset of the IEEE 802.11i standard. WPA2 (IEEE 802.11i) is a wireless security standard that defines stronger encryption, authentication and key management than WPA.

Key differences between WPA or WPA2 and WEP are improved data encryption and user authentication.

If both an AP and the wireless clients support WPA2 and you have an external RADIUS server, use WPA2 for stronger data encryption. If you don't have an external RADIUS server, you should use WPA2-PSK (WPA2-Pre-Shared Key) that only requires a single (identical) password entered into each access point, wireless gateway and wireless client. As long as the passwords match, a wireless client will be granted access to a WLAN.

If the AP or the wireless clients do not support WPA2, just use WPA or WPA-PSK depending on whether you have an external RADIUS server or not.

Select WEP only when the AP and/or wireless clients do not support WPA or WPA2. WEP is less secure than WPA or WPA2.

Encryption

Both WPA and WPA2 improve data encryption by using Temporal Key Integrity Protocol (TKIP), Message Integrity Check (MIC) and IEEE 802.1x. WPA and WPA2

use Advanced Encryption Standard (AES) in the Counter mode with Cipher block chaining Message authentication code Protocol (CCMP) to offer stronger encryption than TKIP.

TKIP uses 128-bit keys that are dynamically generated and distributed by the authentication server. AES (Advanced Encryption Standard) is a block cipher that uses a 256-bit mathematical algorithm called Rijndael. They both include a per-packet key mixing function, a Message Integrity Check (MIC) named Michael, an extended initialization vector (IV) with sequencing rules, and a re-keying mechanism.

WPA and WPA2 regularly change and rotate the encryption keys so that the same encryption key is never used twice.

The RADIUS server distributes a Pairwise Master Key (PMK) key to the AP that then sets up a key hierarchy and management system, using the PMK to dynamically generate unique data encryption keys to encrypt every data packet that is wirelessly communicated between the AP and the wireless clients. This all happens in the background automatically.

The Message Integrity Check (MIC) is designed to prevent an attacker from capturing data packets, altering them and resending them. The MIC provides a strong mathematical function in which the receiver and the transmitter each compute and then compare the MIC. If they do not match, it is assumed that the data has been tampered with and the packet is dropped.

By generating unique data encryption keys for every data packet and by creating an integrity checking mechanism (MIC), with TKIP and AES it is more difficult to decrypt data on a Wi-Fi network than WEP and difficult for an intruder to break into the network.

The encryption mechanisms used for WPA(2) and WPA(2)-PSK are the same. The only difference between the two is that WPA(2)-PSK uses a simple common password, instead of user-specific credentials. The common-password approach makes WPA(2)-PSK susceptible to brute-force password-guessing attacks but it's still an improvement over WEP as it employs a consistent, single, alphanumeric password to derive a PMK which is used to generate unique temporal encryption keys. This prevent all wireless devices sharing the same encryption keys. (a weakness of WEP)

User Authentication

WPA and WPA2 apply IEEE 802.1x and Extensible Authentication Protocol (EAP) to authenticate wireless clients using an external RADIUS database. WPA2 reduces the number of key exchange messages from six to four (CCMP 4-way handshake) and shortens the time required to connect to a network. Other WPA2 authentication features that are different from WPA include key caching and pre-

authentication. These two features are optional and may not be supported in all wireless devices.

Key caching allows a wireless client to store the PMK it derived through a successful authentication with an AP. The wireless client uses the PMK when it tries to connect to the same AP and does not need to go with the authentication process again.

Pre-authentication enables fast roaming by allowing the wireless client (already connecting to an AP) to perform IEEE 802.1x authentication with another AP before connecting to it.

Wireless Client WPA Supplicants

A wireless client supplicant is the software that runs on an operating system instructing the wireless client how to use WPA. At the time of writing, the most widely available supplicant is the WPA patch for Windows XP, Funk Software's Odyssey client.

The Windows XP patch is a free download that adds WPA capability to Windows XP's built-in "Zero Configuration" wireless client. However, you must run Windows XP to use it.

WPA(2) with RADIUS Application Example

To set up WPA(2), you need the IP address of the RADIUS server, its port number (default is 1812), and the RADIUS shared secret. A WPA(2) application example with an external RADIUS server looks as follows. "A" is the RADIUS server. "DS" is the distribution system.

- 1 The AP passes the wireless client's authentication request to the RADIUS server.
- 2 The RADIUS server then checks the user's identification against its database and grants or denies network access accordingly.
- 3 A 256-bit Pairwise Master Key (PMK) is derived from the authentication process by the RADIUS server and the client.

- 4 The RADIUS server distributes the PMK to the AP. The AP then sets up a key hierarchy and management system, using the PMK to dynamically generate unique data encryption keys. The keys are used to encrypt every data packet that is wirelessly communicated between the AP and the wireless clients.

Figure 453 WPA(2) with RADIUS Application Example

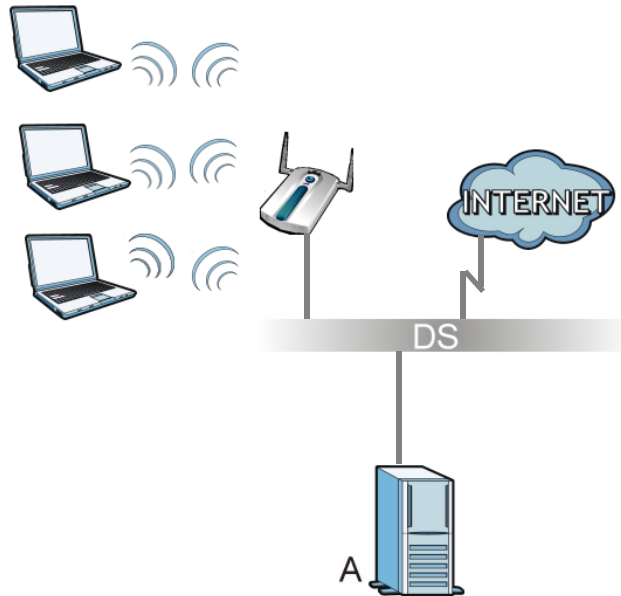

WPA(2)-PSK Application Example

A WPA(2)-PSK application looks as follows.

- 1 First enter identical passwords into the AP and all wireless clients. The Pre-Shared Key (PSK) must consist of between 8 and 63 ASCII characters or 64 hexadecimal characters (including spaces and symbols).
- 2 The AP checks each wireless client's password and allows it to join the network only if the password matches.
- 3 The AP and wireless clients generate a common PMK (Pairwise Master Key). The key itself is not sent over the network, but is derived from the PSK and the SSID.

- 4 The AP and wireless clients use the TKIP or AES encryption process, the PMK and information exchanged in a handshake to create temporal encryption keys. They use these keys to encrypt data exchanged between them.

Figure 454 WPA(2)-PSK Authentication

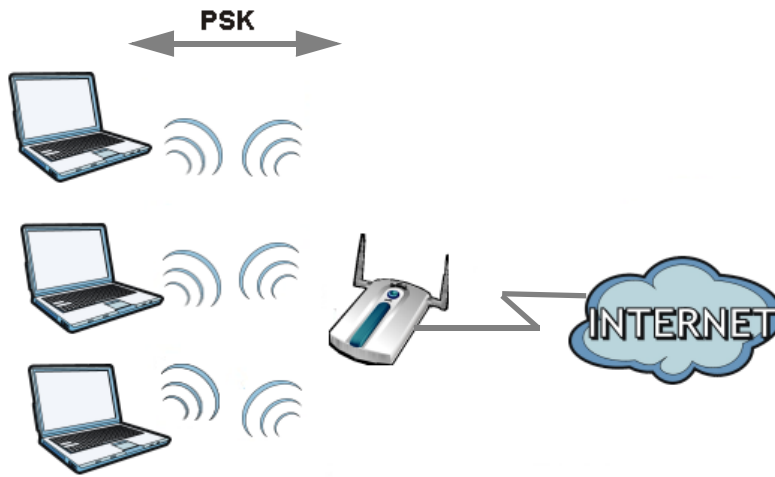

Security Parameters Summary

Refer to this table to see what other security parameters you should configure for each authentication method or key management protocol type. MAC address filters are not dependent on how you configure these security features.

Table 273 Wireless Security Relational Matrix

AUTHENTICATION METHOD/ KEY MANAGEMENT PROTOCOL	ENCRYPTIO N METHOD	ENTER MANUAL KEY	IEEE 802.1X
Open	None	No	Disable
			Enable without Dynamic WEP Key
Open	WEP	No	Enable with Dynamic WEP Key
		Yes	Enable without Dynamic WEP Key
		Yes	Disable
Shared	WEP	No	Enable with Dynamic WEP Key
		Yes	Enable without Dynamic WEP Key
		Yes	Disable
WPA	TKIP/AES	No	Enable
WPA-PSK	TKIP/AES	Yes	Disable
WPA2	TKIP/AES	No	Enable
WPA2-PSK	TKIP/AES	Yes	Disable

Antenna Overview

An antenna couples RF signals onto air. A transmitter within a wireless device sends an RF signal to the antenna, which propagates the signal through the air. The antenna also operates in reverse by capturing RF signals from the air.

Positioning the antennas properly increases the range and coverage area of a wireless LAN.

Antenna Characteristics

Frequency

An antenna in the frequency of 2.4GHz (IEEE 802.11b and IEEE 802.11g) or 5GHz (IEEE 802.11a) is needed to communicate efficiently in a wireless LAN

Radiation Pattern

A radiation pattern is a diagram that allows you to visualize the shape of the antenna's coverage area.

Antenna Gain

Antenna gain, measured in dB (decibel), is the increase in coverage within the RF beam width. Higher antenna gain improves the range of the signal for better communications.

For an indoor site, each 1 dB increase in antenna gain results in a range increase of approximately 2.5%. For an unobstructed outdoor site, each 1dB increase in gain results in a range increase of approximately 5%. Actual results may vary depending on the network environment.

Antenna gain is sometimes specified in dBi, which is how much the antenna increases the signal power compared to using an isotropic antenna. An isotropic antenna is a theoretical perfect antenna that sends out radio signals equally well in all directions. dBi represents the true gain that the antenna provides.

Types of Antennas for WLAN

There are two types of antennas used for wireless LAN applications.

- Omni-directional antennas send the RF signal out in all directions on a horizontal plane. The coverage area is torus-shaped (like a donut) which makes these antennas ideal for a room environment. With a wide coverage area, it is possible to make circular overlapping coverage areas with multiple access points.
- Directional antennas concentrate the RF signal in a beam, like a flashlight does with the light from its bulb. The angle of the beam determines the width of the coverage pattern. Angles typically range from 20 degrees (very directional) to 120 degrees (less directional). Directional antennas are ideal for hallways and outdoor point-to-point applications.

Positioning Antennas

In general, antennas should be mounted as high as practically possible and free of obstructions. In point-to-point application, position both antennas at the same height and in a direct line of sight to each other to attain the best performance.

For omni-directional antennas mounted on a table, desk, and so on, point the antenna up. For omni-directional antennas mounted on a wall or ceiling, point the antenna down. For a single AP application, place omni-directional antennas as close to the center of the coverage area as possible.

For directional antennas, point the antenna in the direction of the desired coverage area.

Importing Certificates

This appendix shows you how to import public key certificates into your web browser.

Public key certificates are used by web browsers to ensure that a secure web site is legitimate. When a certificate authority such as VeriSign, Comodo, or Network Solutions, to name a few, receives a certificate request from a website operator, they confirm that the web domain and contact information in the request match those on public record with a domain name registrar. If they match, then the certificate is issued to the website operator, who then places it on the site to be issued to all visiting web browsers to let them know that the site is legitimate.

Many ZyXEL products, such as the ZyWALL, issue their own public key certificates. These can be used by web browsers on a LAN or WAN to verify that they are in fact connecting to the legitimate device and not one masquerading as it. However, because the certificates were not issued by one of the several organizations officially recognized by the most common web browsers, you will need to import the ZyXEL-created certificate into your web browser and flag that certificate as a trusted authority.

Note: You can see if you are browsing on a secure website if the URL in your web browser's address bar begins with `https://` or there is a sealed padlock icon () somewhere in the main browser window (not all browsers show the padlock in the same location.)

In this appendix, you can import a public key certificate for:

- Internet Explorer on [page 819](#)
- Firefox on [page 828](#)
- Opera on [page 833](#)
- Konqueror on [page 840](#)

Internet Explorer

The following example uses Microsoft Internet Explorer 7 on Windows XP Professional; however, they can also apply to Internet Explorer on Windows Vista.

- 1 If your device's Web Configurator is set to use SSL certification, then the first time you browse to it you are presented with a certification error.

Figure 455 Internet Explorer 7: Certification Error

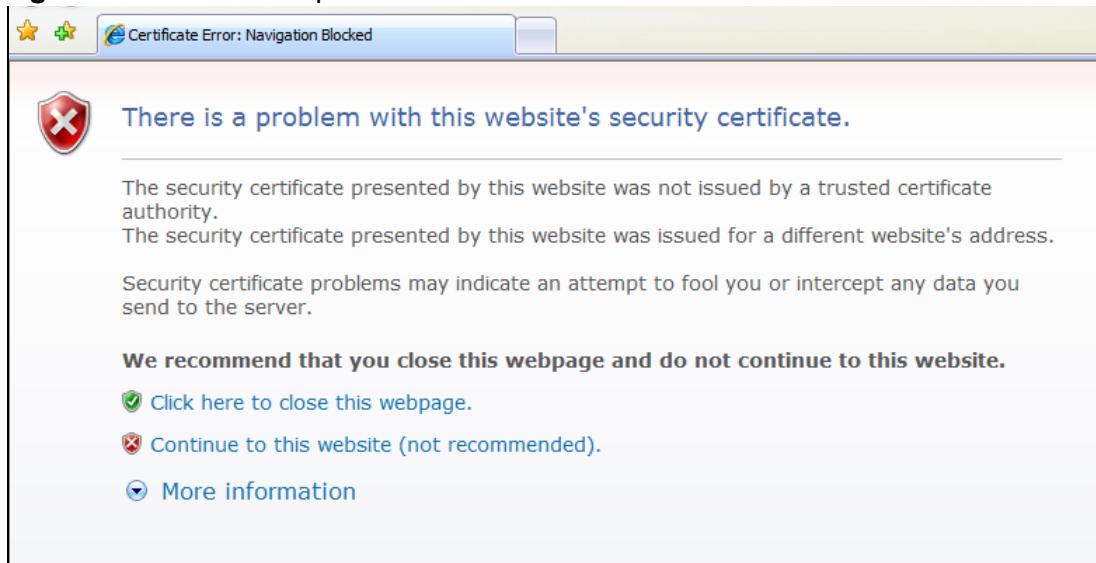

- 2 Click **Continue to this website (not recommended)**.

Figure 456 Internet Explorer 7: Certification Error



- 3 In the **Address Bar**, click **Certificate Error > View certificates**.

Figure 457 Internet Explorer 7: Certificate Error

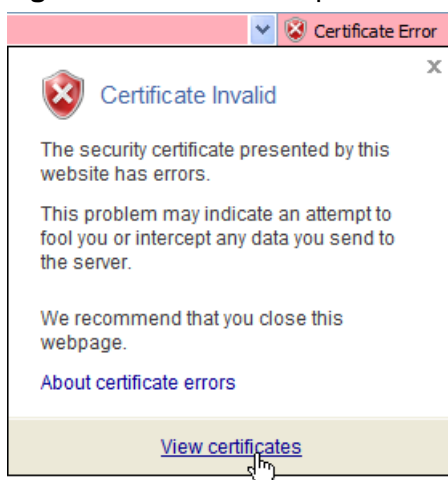

- 4 In the **Certificate** dialog box, click **Install Certificate**.

Figure 458 Internet Explorer 7: Certificate

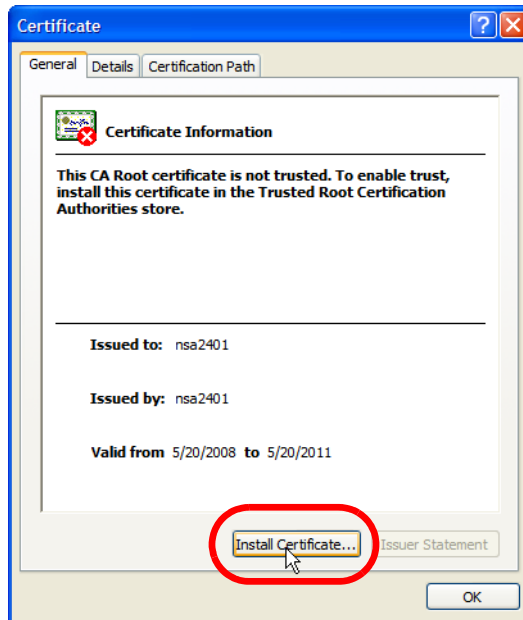

- 5 In the **Certificate Import Wizard**, click **Next**.

Figure 459 Internet Explorer 7: Certificate Import Wizard

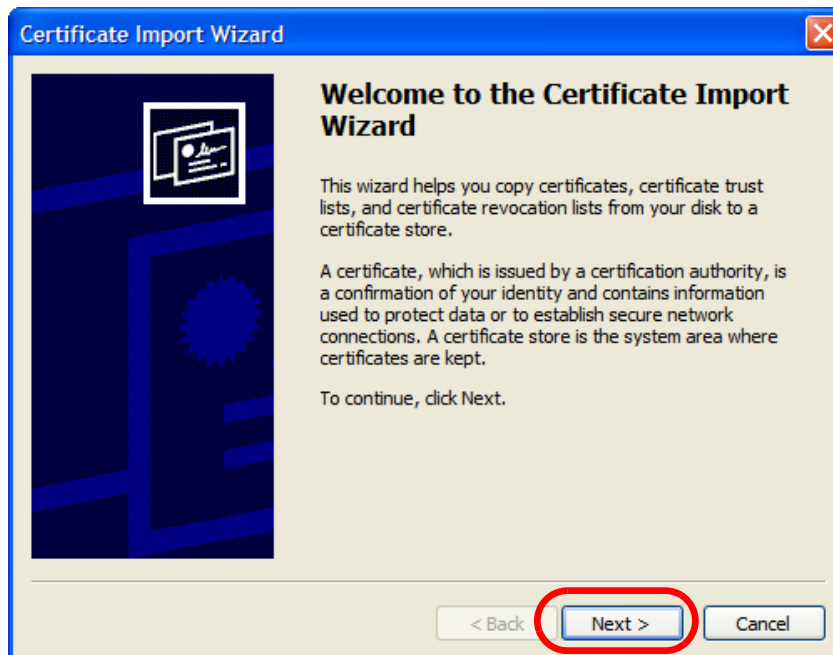

- 6 If you want Internet Explorer to **Automatically select certificate store based on the type of certificate**, click **Next** again and then go to step 9.

Figure 460 Internet Explorer 7: Certificate Import Wizard

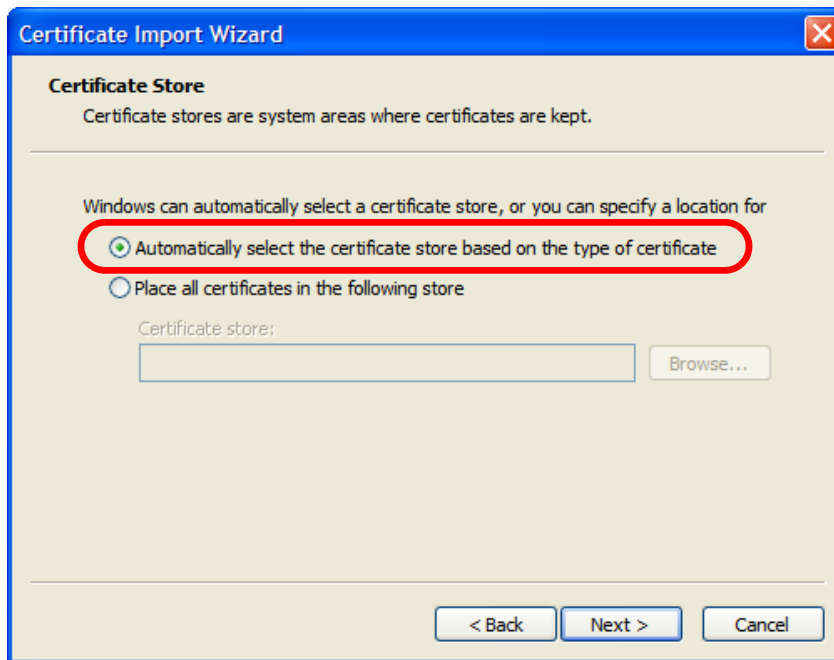

- 7 Otherwise, select **Place all certificates in the following store** and then click **Browse**.

Figure 461 Internet Explorer 7: Certificate Import Wizard

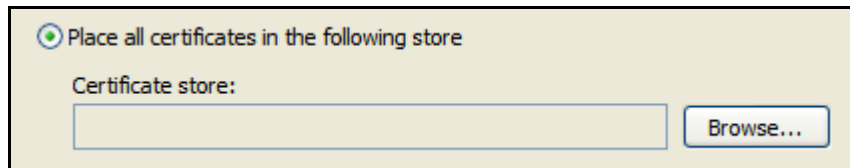

- 8 In the **Select Certificate Store** dialog box, choose a location in which to save the certificate and then click **OK**.

Figure 462 Internet Explorer 7: Select Certificate Store

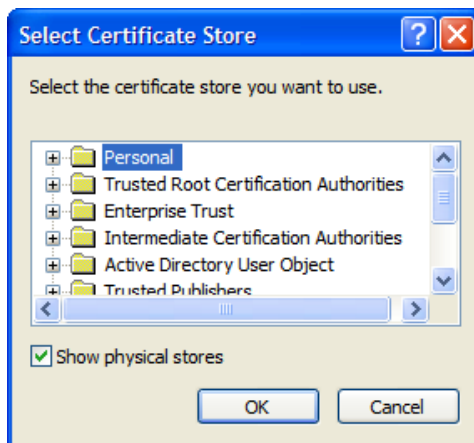

- 9 In the **Completing the Certificate Import Wizard** screen, click **Finish**.

Figure 463 Internet Explorer 7: Certificate Import Wizard

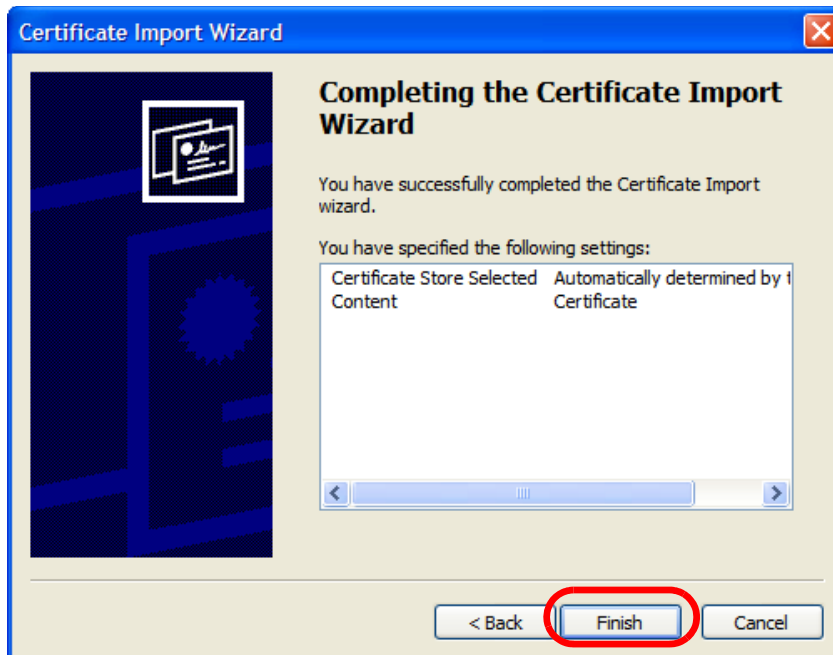

- If you are presented with another **Security Warning**, click **Yes**.

Figure 464 Internet Explorer 7: Security Warning

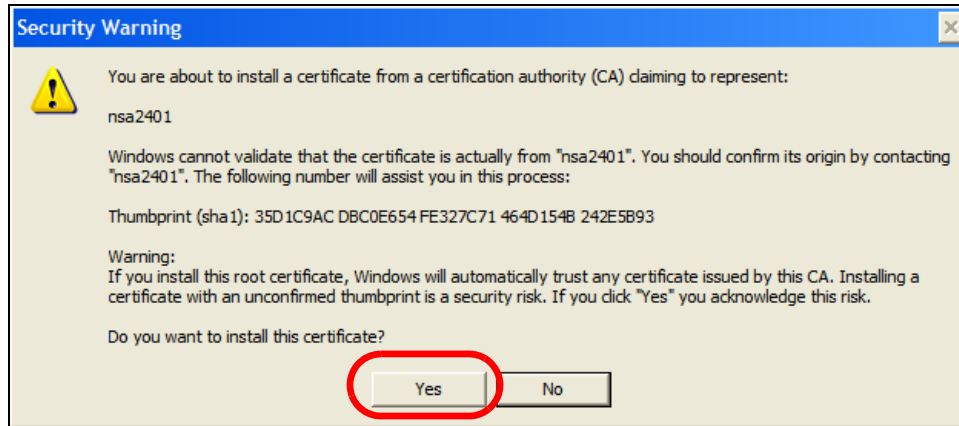

- Finally, click **OK** when presented with the successful certificate installation message.

Figure 465 Internet Explorer 7: Certificate Import Wizard

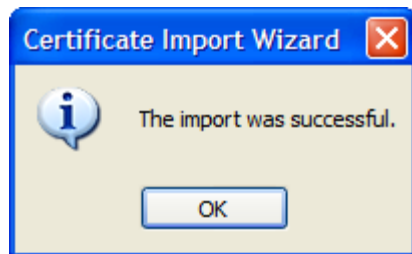

- The next time you start Internet Explorer and go to a ZyXEL Web Configurator page, a sealed padlock icon appears in the address bar. Click it to view the page's **Website Identification** information.

Figure 466 Internet Explorer 7: Website Identification

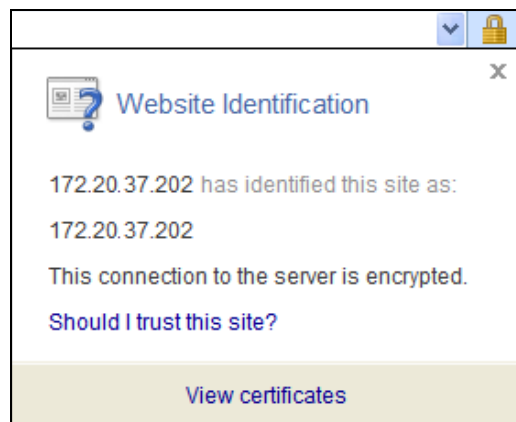

Installing a Stand-Alone Certificate File in Internet Explorer

Rather than browsing to a ZyXEL Web Configurator and installing a public key certificate when prompted, you can install a stand-alone certificate file if one has been issued to you.

- 1 Double-click the public key certificate file.

Figure 467 Internet Explorer 7: Public Key Certificate File



CA.cer

- 2 In the security warning dialog box, click **Open**.

Figure 468 Internet Explorer 7: Open File - Security Warning

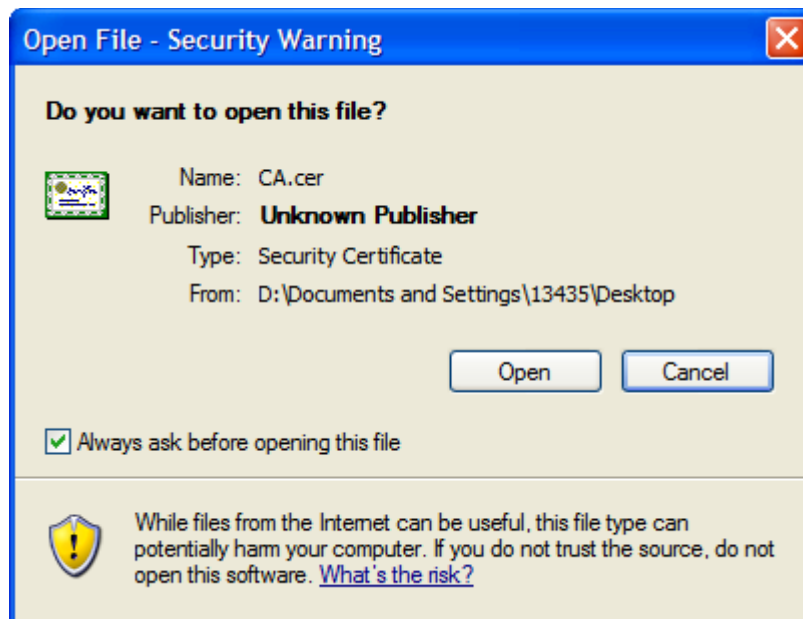

- 3 Refer to steps 4-12 in the Internet Explorer procedure beginning on [page 819](#) to complete the installation process.

Removing a Certificate in Internet Explorer

This section shows you how to remove a public key certificate in Internet Explorer 7.

- 1 Open **Internet Explorer** and click **Tools > Internet Options**.

Figure 469 Internet Explorer 7: Tools Menu

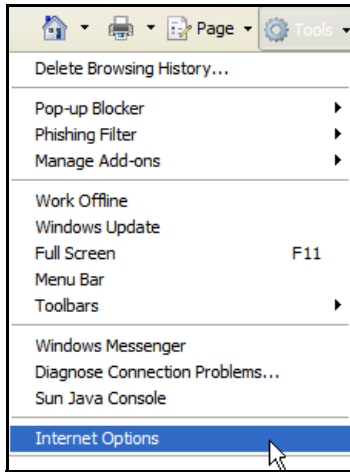

- 2 In the **Internet Options** dialog box, click **Content > Certificates**.

Figure 470 Internet Explorer 7: Internet Options

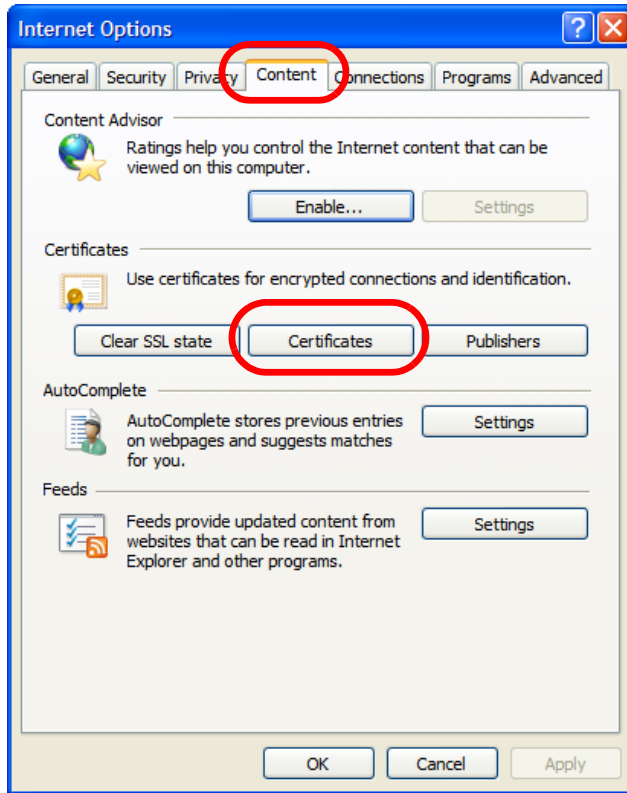

- 3 In the **Certificates** dialog box, click the **Trusted Root Certificates Authorities** tab, select the certificate that you want to delete, and then click **Remove**.

Figure 471 Internet Explorer 7: Certificates

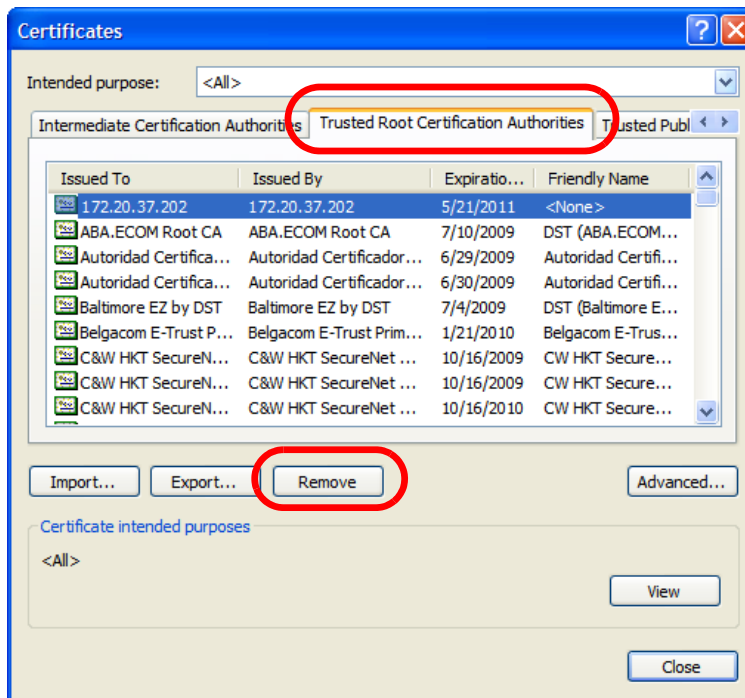

- 4 In the **Certificates** confirmation, click **Yes**.

Figure 472 Internet Explorer 7: Certificates



- 5 In the **Root Certificate Store** dialog box, click **Yes**.

Figure 473 Internet Explorer 7: Root Certificate Store

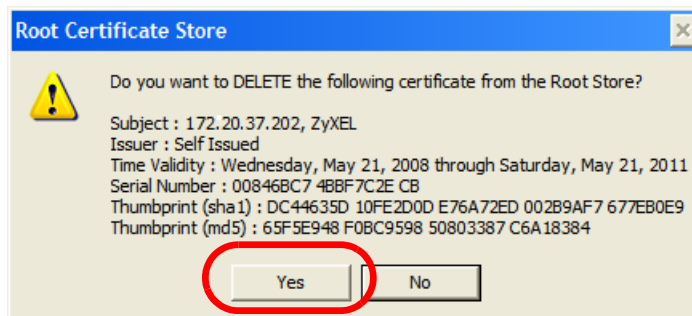

- 6 The next time you go to the web site that issued the public key certificate you just removed, a certification error appears.

Firefox

The following example uses Mozilla Firefox 2 on Windows XP Professional; however, the screens can also apply to Firefox 2 on all platforms.

- 1 If your device's Web Configurator is set to use SSL certification, then the first time you browse to it you are presented with a certification error.
- 2 Select **Accept this certificate permanently** and click **OK**.

Figure 474 Firefox 2: Website Certified by an Unknown Authority

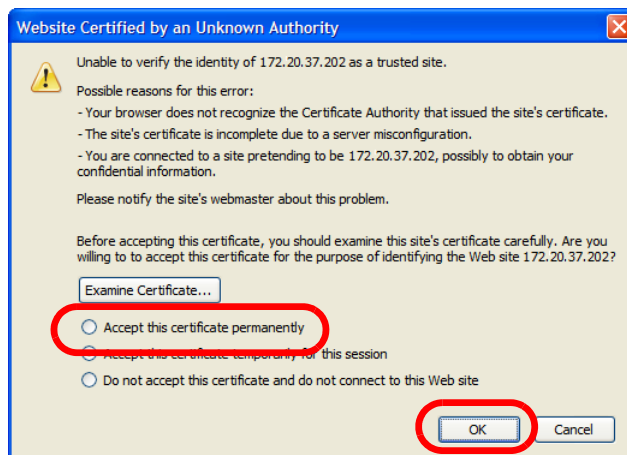

- The certificate is stored and you can now connect securely to the Web Configurator. A sealed padlock appears in the address bar, which you can click to open the **Page Info > Security** window to view the web page's security information.

Figure 475 Firefox 2: Page Info



Installing a Stand-Alone Certificate File in Firefox

Rather than browsing to a ZyXEL Web Configurator and installing a public key certificate when prompted, you can install a stand-alone certificate file if one has been issued to you.

- 1 Open **Firefox** and click **Tools > Options**.

Figure 476 Firefox 2: Tools Menu

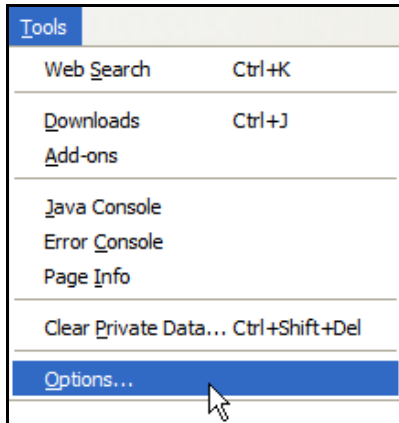

- 2 In the **Options** dialog box, click **Advanced > Encryption > View Certificates**.

Figure 477 Firefox 2: Options

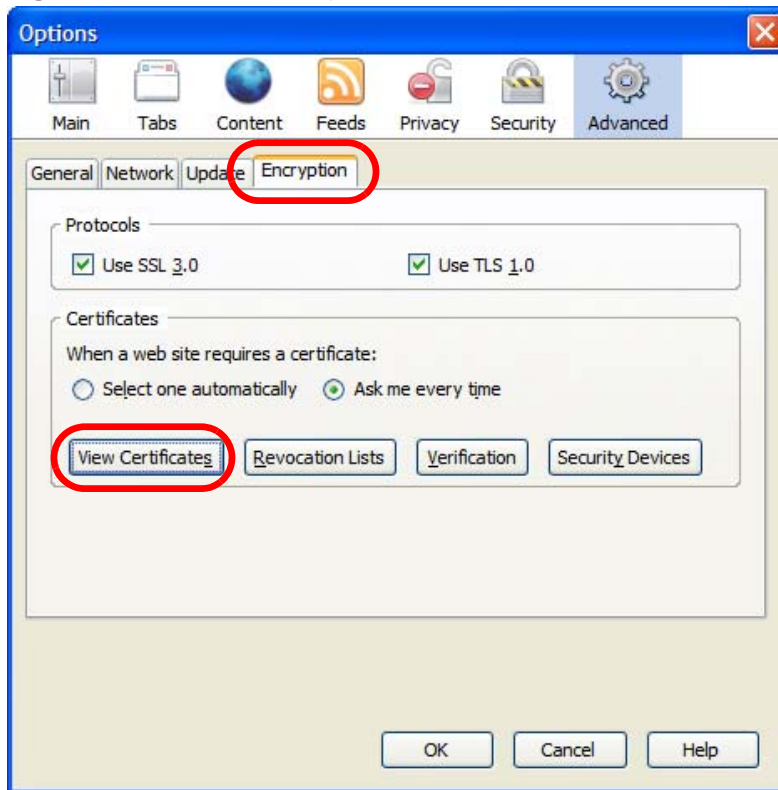

- 3 In the **Certificate Manager** dialog box, click **Web Sites > Import**.

Figure 478 Firefox 2: Certificate Manager

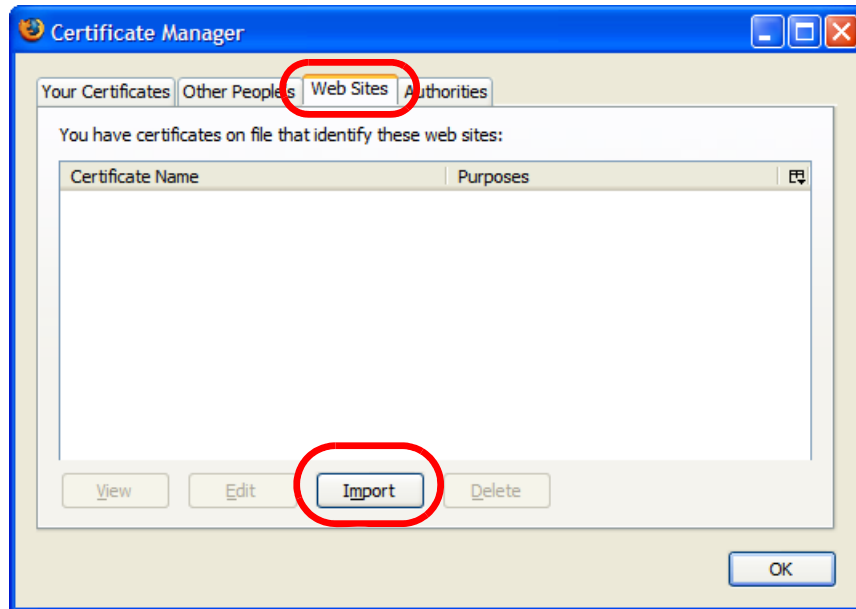

- 4 Use the **Select File** dialog box to locate the certificate and then click **Open**.

Figure 479 Firefox 2: Select File

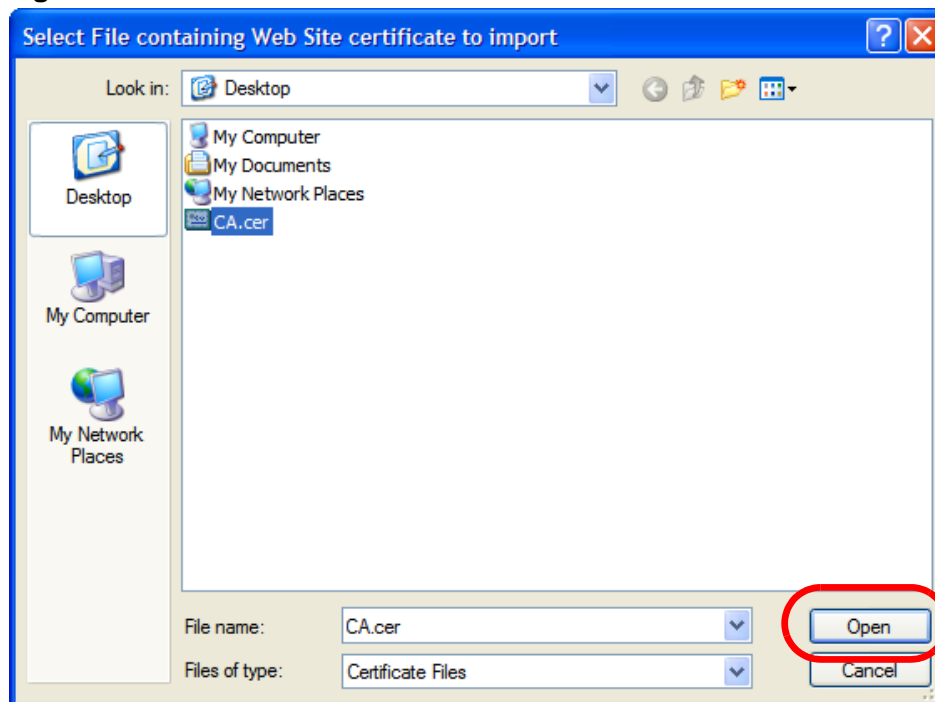

- 5 The next time you visit the web site, click the padlock in the address bar to open the **Page Info > Security** window to see the web page's security information.

Removing a Certificate in Firefox

This section shows you how to remove a public key certificate in Firefox 2.

- 1 Open **Firefox** and click **Tools > Options**.

Figure 480 Firefox 2: Tools Menu

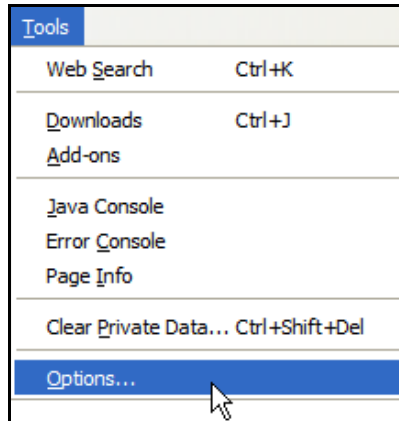

- 2 In the **Options** dialog box, click **Advanced > Encryption > View Certificates**.

Figure 481 Firefox 2: Options

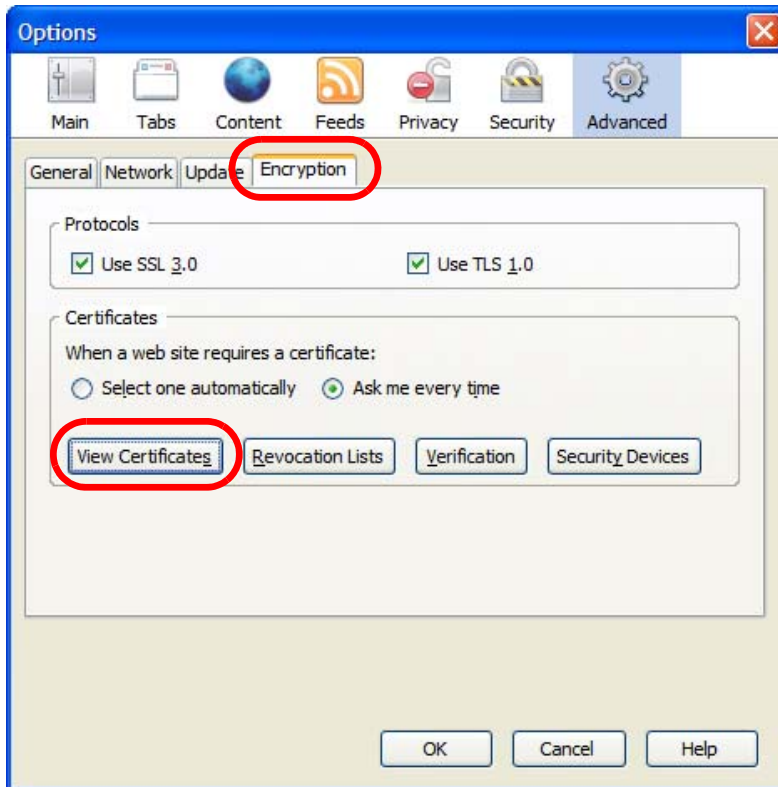

- 3 In the **Certificate Manager** dialog box, select the **Web Sites** tab, select the certificate that you want to remove, and then click **Delete**.

Figure 482 Firefox 2: Certificate Manager

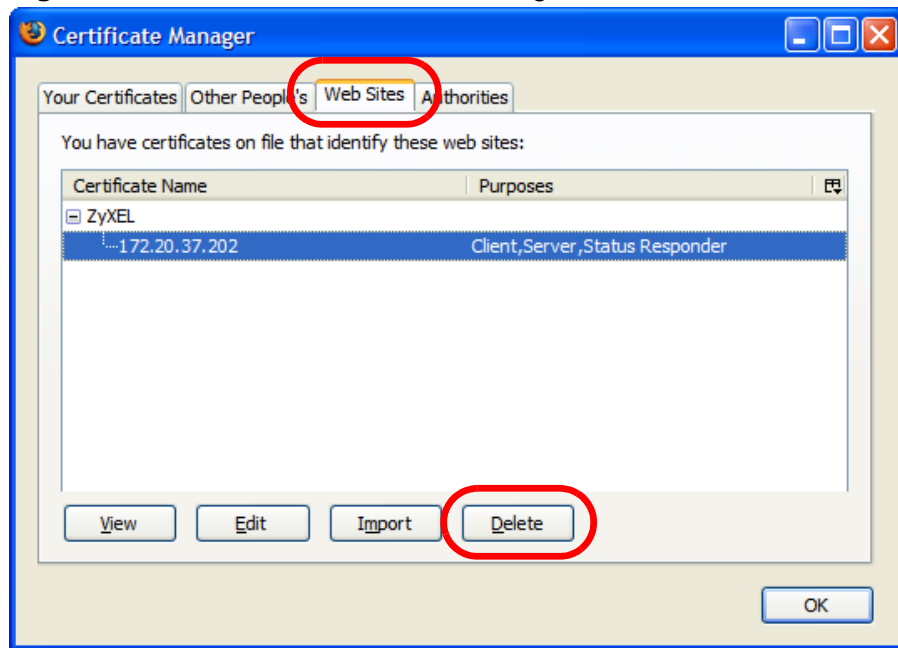

- 4 In the **Delete Web Site Certificates** dialog box, click **OK**.

Figure 483 Firefox 2: Delete Web Site Certificates

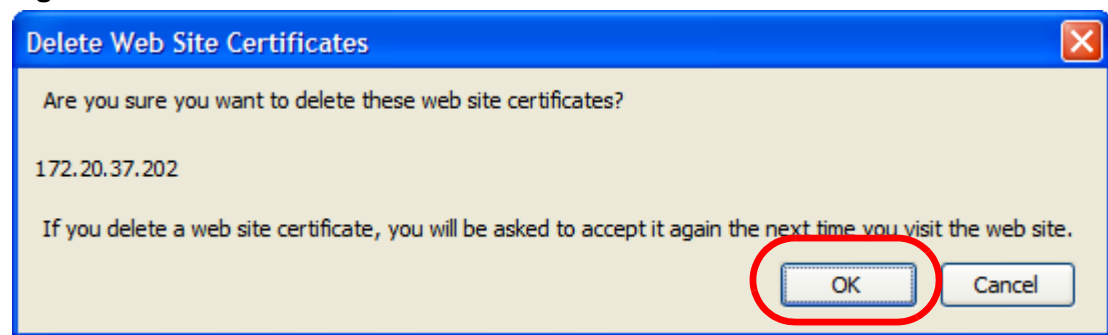

- 5 The next time you go to the web site that issued the public key certificate you just removed, a certification error appears.

Opera

The following example uses Opera 9 on Windows XP Professional; however, the screens can apply to Opera 9 on all platforms.

- 1 If your device's Web Configurator is set to use SSL certification, then the first time you browse to it you are presented with a certification error.
- 2 Click **Install** to accept the certificate.

Figure 484 Opera 9: Certificate signer not found

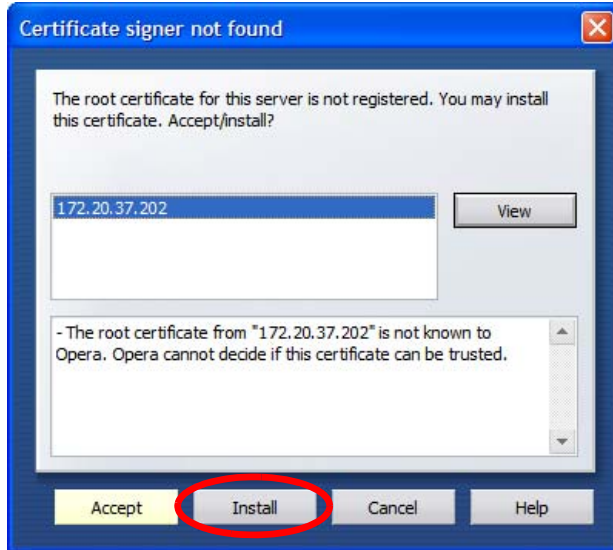

- 3 The next time you visit the web site, click the padlock in the address bar to open the **Security information** window to view the web page's security details.

Figure 485 Opera 9: Security information

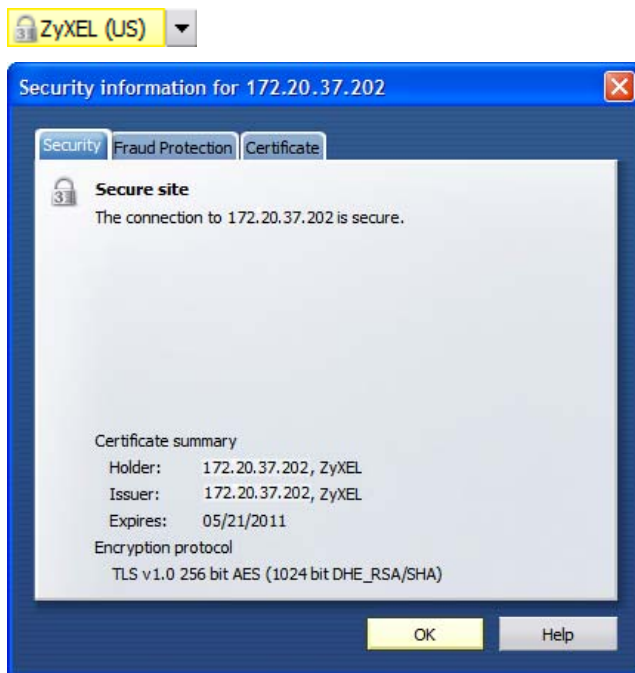

Installing a Stand-Alone Certificate File in Opera

Rather than browsing to a ZyXEL Web Configurator and installing a public key certificate when prompted, you can install a stand-alone certificate file if one has been issued to you.

- 1 Open **Opera** and click **Tools > Preferences**.

Figure 486 Opera 9: Tools Menu

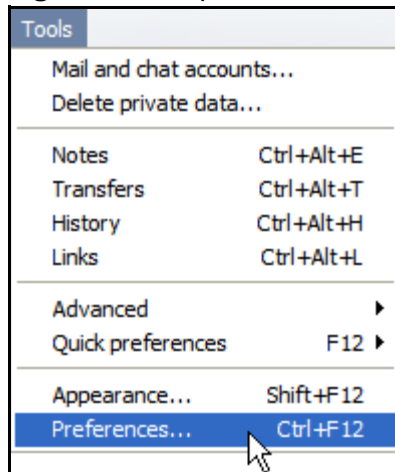

- 2 In Preferences, click **Advanced** > **Security** > **Manage certificates**.

Figure 487 Opera 9: Preferences

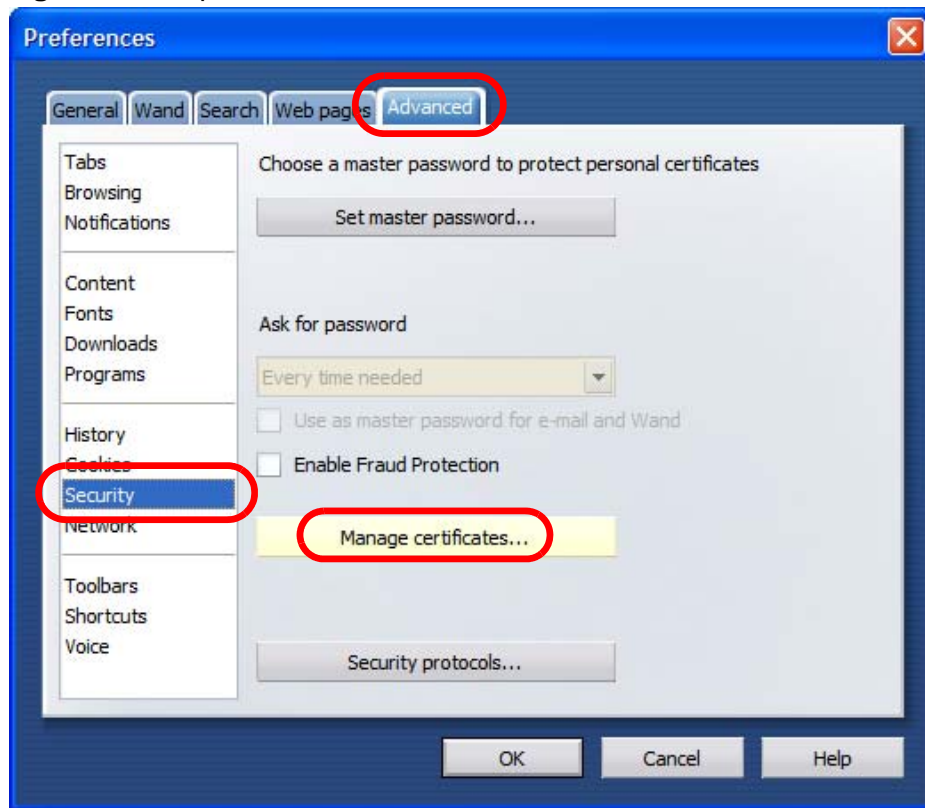

- 3 In the **Certificates Manager**, click **Authorities > Import**.

Figure 488 Opera 9: Certificate manager

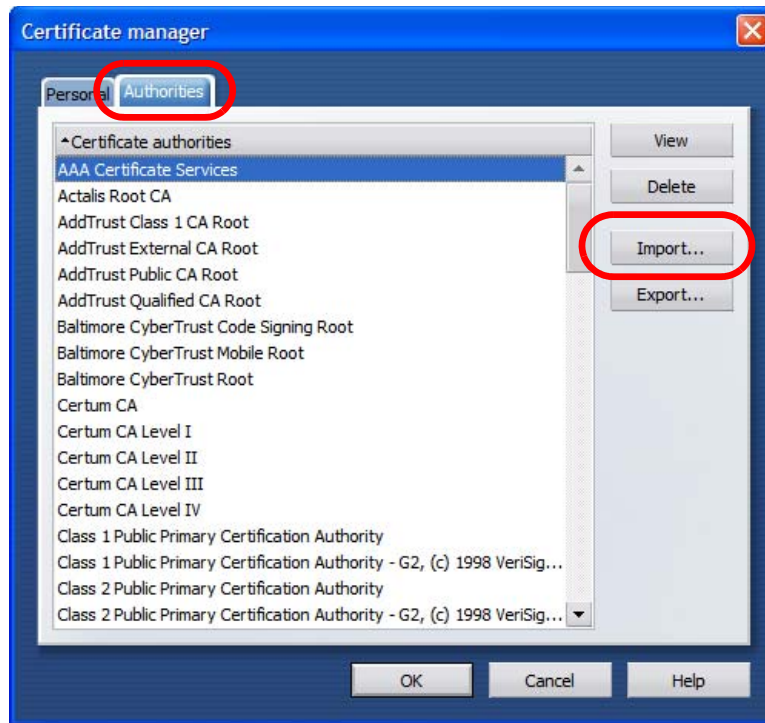

- 4 Use the **Import certificate** dialog box to locate the certificate and then click **Open**.

Figure 489 Opera 9: Import certificate

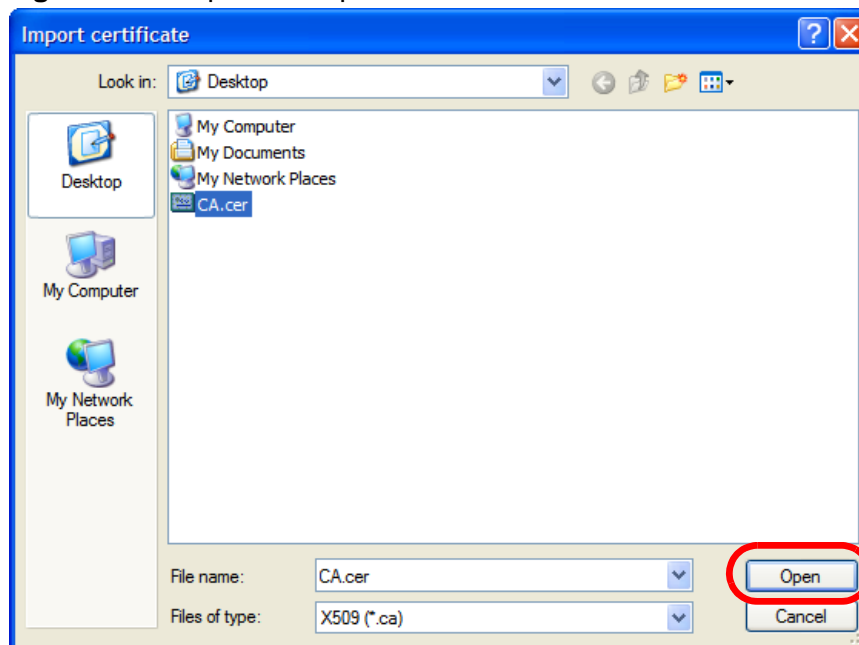

- 5 In the **Install authority certificate** dialog box, click **Install**.

Figure 490 Opera 9: Install authority certificate

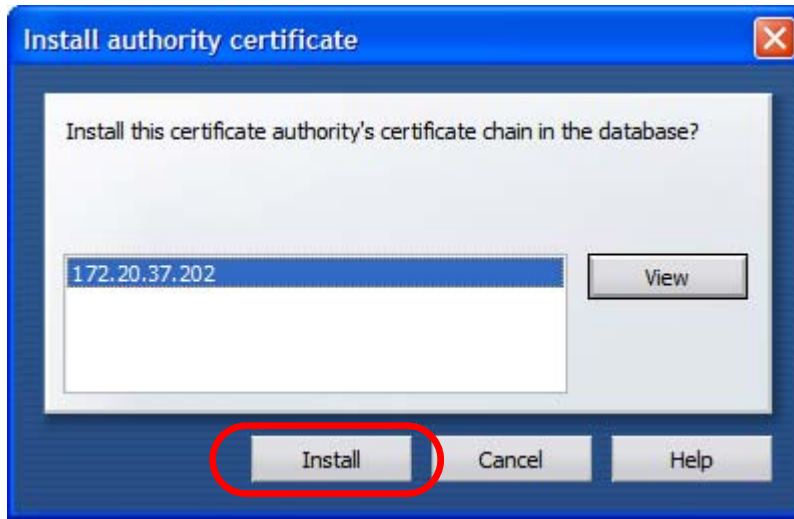

- 6 Next, click **OK**.

Figure 491 Opera 9: Install authority certificate

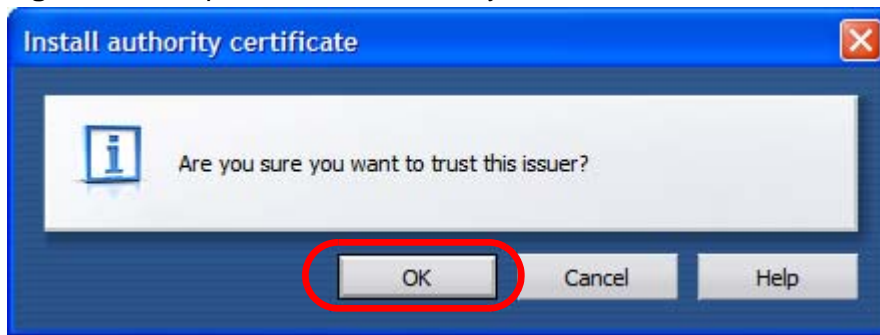

- 7 The next time you visit the web site, click the padlock in the address bar to open the **Security information** window to view the web page's security details.

Removing a Certificate in Opera

This section shows you how to remove a public key certificate in Opera 9.

- 1 Open **Opera** and click **Tools > Preferences**.

Figure 492 Opera 9: Tools Menu

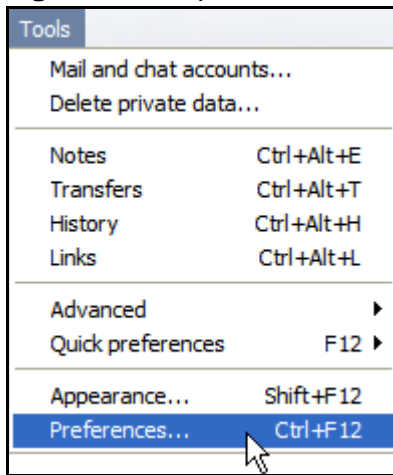

- 2 In **Preferences**, **Advanced > Security > Manage certificates**.

Figure 493 Opera 9: Preferences

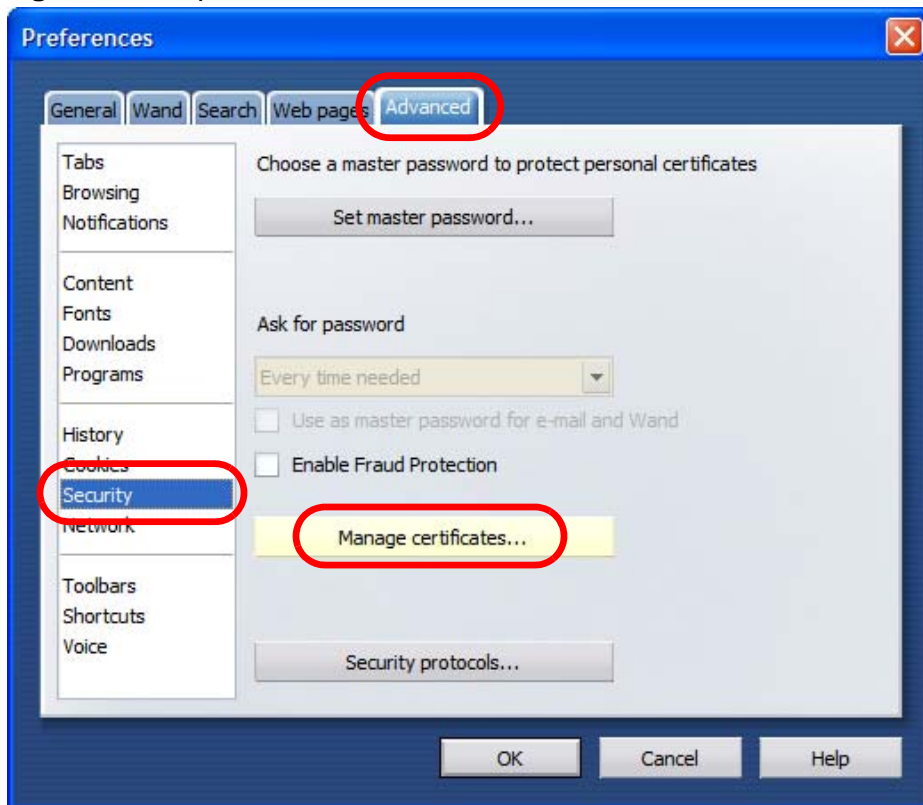

- 3 In the **Certificates manager**, select the **Authorities** tab, select the certificate that you want to remove, and then click **Delete**.

Figure 494 Opera 9: Certificate manager

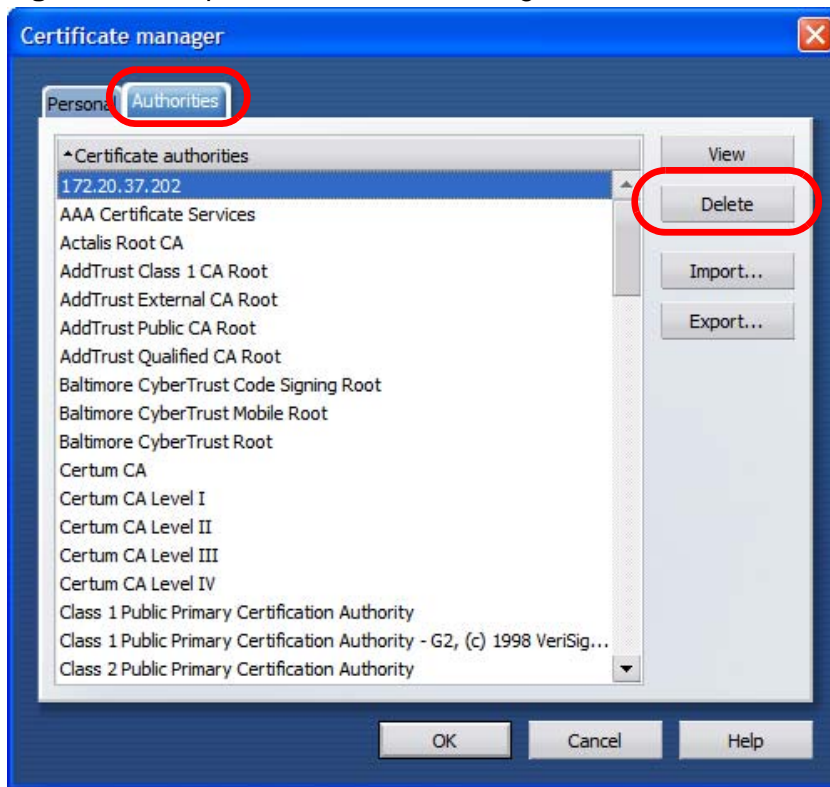

- 4 The next time you go to the web site that issued the public key certificate you just removed, a certification error appears.

Note: There is no confirmation when you delete a certificate authority, so be absolutely certain that you want to go through with it before clicking the button.

Konqueror

The following example uses Konqueror 3.5 on openSUSE 10.3, however the screens apply to Konqueror 3.5 on all Linux KDE distributions.

- 1 If your device's Web Configurator is set to use SSL certification, then the first time you browse to it you are presented with a certification error.

- 2 Click **Continue**.

Figure 495 Konqueror 3.5: Server Authentication



- 3 Click **Forever** when prompted to accept the certificate.

Figure 496 Konqueror 3.5: Server Authentication



- 4 Click the padlock in the address bar to open the **KDE SSL Information** window and view the web page's security details.

Figure 497 Konqueror 3.5: KDE SSL Information

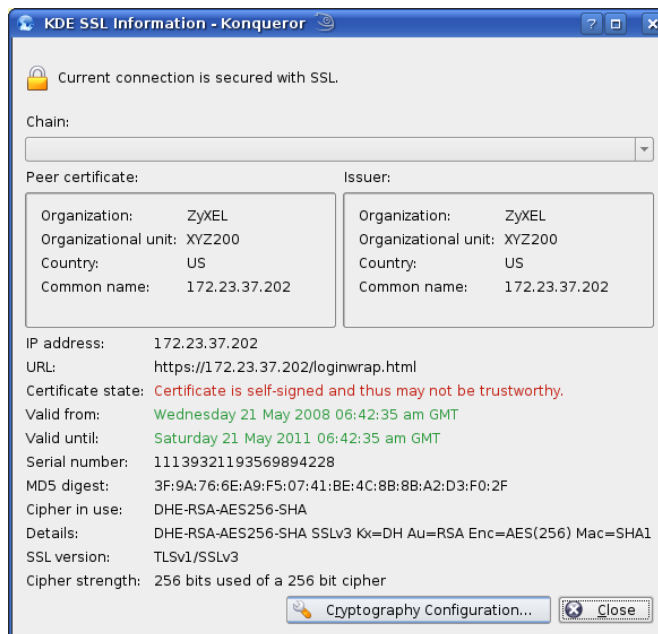

- 3 The next time you visit the web site, click the padlock in the address bar to open the **KDE SSL Information** window to view the web page's security details.

Removing a Certificate in Konqueror

This section shows you how to remove a public key certificate in Konqueror 3.5.

- 1 Open **Konqueror** and click **Settings > Configure Konqueror**.

Figure 501 Konqueror 3.5: Settings Menu

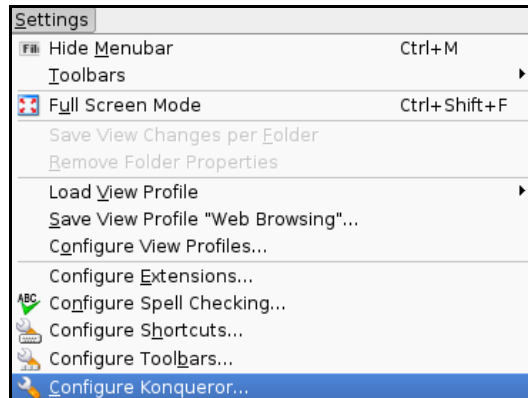

- 2 In the **Configure** dialog box, select **Crypto**.
- 3 On the **Peer SSL Certificates** tab, select the certificate you want to delete and then click **Remove**.

Figure 502 Konqueror 3.5: Configure

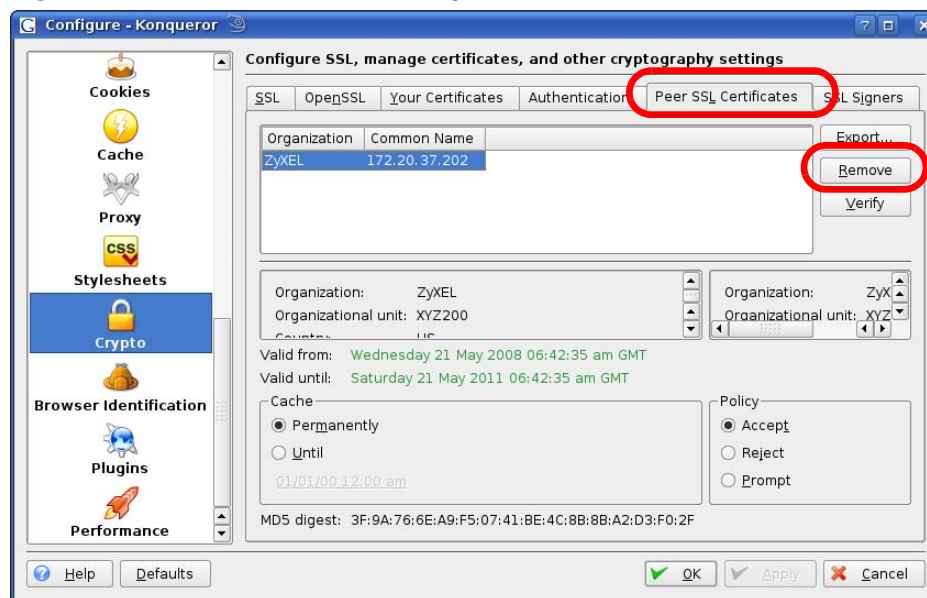

- 4 The next time you go to the web site that issued the public key certificate you just removed, a certification error appears.

Note: There is no confirmation when you remove a certificate authority, so be absolutely certain you want to go through with it before clicking the button.

Open Software Announcements

End-User License Agreement for “ZyWALL USG 20”

WARNING: ZyXEL Communications Corp. IS WILLING TO LICENSE THE SOFTWARE TO YOU ONLY UPON THE CONDITION THAT YOU ACCEPT ALL OF THE TERMS CONTAINED IN THIS LICENSE AGREEMENT. PLEASE READ THE TERMS CAREFULLY BEFORE COMPLETING THE INSTALLATION PROCESS AS INSTALLING THE SOFTWARE WILL INDICATE YOUR ASSENT TO THEM. IF YOU DO NOT AGREE TO THESE TERMS, THEN ZyXEL IS UNWILLING TO LICENSE THE SOFTWARE TO YOU, IN WHICH EVENT YOU SHOULD RETURN THE UNINSTALLED SOFTWARE AND PACKAGING TO THE PLACE FROM WHICH IT WAS ACQUIRED OR ZyXEL, AND YOUR MONEY WILL BE REFUNDED. HOWEVER CERTAIN COMPONENTS OF THE SOFTWARE, AND THIRD PARTY OPEN SOURCE PROGRAMS INCLUDED WITH THE SOFTWARE, HAVE BEEN OR MAY BE MADE AVAILABLE BY ZyXEL LISTED IN THE BELOW NOTICE (COLLECTIVELY THE “OPEN-SOURCED COMPONENTS”). FOR THESE OPEN-SOURCED COMPONENTS YOU SHOULD COMPLY WITH THE TERMS OF THIS LICENSE AND ANY APPLICABLE LICENSING TERMS GOVERNING USE OF THE OPEN-SOURCED COMPONENTS, WHICH HAVE BEEN PROVIDED ON THE LICENSE NOTICE AS BELOW FOR THE SOFTWARE.

1. Grant of License for Personal Use

ZyXEL Communications Corp. ("ZyXEL") grants you a non-exclusive, non-sublicense, non-transferable license to use the program with which this license is distributed (the "Software"), including any documentation files accompanying the Software ("Documentation"), for internal business use only, for up to the number of users specified in sales order and invoice. You have the right to make one backup copy of the Software and Documentation solely for archival, back-up or disaster recovery purposes. You shall not exceed the scope of the license granted hereunder. Any rights not expressly granted by ZyXEL to you are reserved by ZyXEL, and all implied licenses are disclaimed.

2. Ownership

You have no ownership rights in the Software. Rather, you have a license to use the Software as long as this License Agreement remains in full force and effect. Ownership of the Software, Documentation and all intellectual property rights

therein shall remain at all times with ZyXEL. Any other use of the Software by any other entity is strictly forbidden and is a violation of this License Agreement.

3. Copyright

The Software and Documentation contain material that is protected by International Copyright Law and trade secret law, and by international treaty provisions. All rights not granted to you herein are expressly reserved by ZyXEL. You may not remove any proprietary notice of ZyXEL or any of its licensors from any copy of the Software or Documentation.

4. Restrictions

You may not publish, display, disclose, sell, rent, lease, modify, store, loan, distribute, or create derivative works of the Software, or any part thereof. You may not assign, sublicense, convey or otherwise transfer, pledge as security or otherwise encumber the rights and licenses granted hereunder with respect to the Software. Certain components of the Software, and third party open source programs included with the Software, have been or may be made available by ZyXEL listed in the below Notice (collectively the "Open-Sourced Components") You may modify or replace only these Open-Sourced Components; provided that you comply with the terms of this License and any applicable licensing terms governing use of the Open-Sourced Components, which have been provided on the License Notice as below for the Software. ZyXEL is not obligated to provide any maintenance, technical or other support for the resultant modified Software. You may not copy, reverse engineer, decompile, reverse compile, translate, adapt, or disassemble the Software, or any part thereof, nor shall you attempt to create the source code from the object code for the Software. Except as and only to the extent expressly permitted in this License, by applicable licensing terms governing use of the Open-Sourced Components, or by applicable law, you may not market, co-brand, private label or otherwise permit third parties to link to the Software, or any part thereof. You may not use the Software, or any part thereof, in the operation of a service bureau or for the benefit of any other person or entity. You may not cause, assist or permit any third party to do any of the foregoing. Portions of the Software utilize or include third party software and other copyright material. Acknowledgements, licensing terms and disclaimers for such material are contained in the License Notice as below for the Software, and your use of such material is governed by their respective terms. ZyXEL has provided, as part of the Software package, access to certain third party software as a convenience. To the extent that the Software contains third party software, ZyXEL has no express or implied obligation to provide any technical or other support for such software. Please contact the appropriate software vendor or manufacturer directly for technical support and customer service related to its software and products.

5. Confidentiality

You acknowledge that the Software contains proprietary trade secrets of ZyXEL and you hereby agree to maintain the confidentiality of the Software using at least as great a degree of care as you use to maintain the confidentiality of your own most confidential information. You agree to reasonably communicate the terms and conditions of this License Agreement to those persons employed by you who come into contact with the Software, and to use reasonable best efforts to ensure their compliance with such terms and conditions, including, without limitation, not knowingly permitting such persons to use any portion of the Software for the purpose of deriving the source code of the Software.

6. No Warranty

THE SOFTWARE IS PROVIDED "AS IS." TO THE MAXIMUM EXTENT PERMITTED BY LAW, ZyXEL DISCLAIMS ALL WARRANTIES OF ANY KIND, EITHER EXPRESSED OR IMPLIED, INCLUDING, WITHOUT LIMITATION, IMPLIED WARRANTIES OF MERCHANTABILITY AND FITNESS FOR A PARTICULAR PURPOSE. ZyXEL DOES NOT WARRANT THAT THE FUNCTIONS CONTAINED IN THE SOFTWARE WILL MEET ANY REQUIREMENTS OR NEEDS YOU MAY HAVE, OR THAT THE SOFTWARE WILL OPERATE ERROR FREE, OR IN AN UNINTERRUPTED FASHION, OR THAT ANY DEFECTS OR ERRORS IN THE SOFTWARE WILL BE CORRECTED, OR THAT THE SOFTWARE IS COMPATIBLE WITH ANY PARTICULAR PLATFORM. SOME JURISDICTIONS DO NOT ALLOW THE WAIVER OR EXCLUSION OF IMPLIED WARRANTIES SO THEY MAY NOT APPLY TO YOU. IF THIS EXCLUSION IS HELD TO BE UNENFORCEABLE BY A COURT OF COMPETENT JURISDICTION, THEN ALL EXPRESS AND IMPLIED WARRANTIES SHALL BE LIMITED IN DURATION TO A PERIOD OF THIRTY (30) DAYS FROM THE DATE OF PURCHASE OF THE SOFTWARE, AND NO WARRANTIES SHALL APPLY AFTER THAT PERIOD.

7. Limitation of Liability

IN NO EVENT WILL ZyXEL BE LIABLE TO YOU OR ANY THIRD PARTY FOR ANY INCIDENTAL OR CONSEQUENTIAL DAMAGES (INCLUDING, WITHOUT LIMITATION, INDIRECT, SPECIAL, PUNITIVE, OR EXEMPLARY DAMAGES FOR LOSS OF BUSINESS, LOSS OF PROFITS, BUSINESS INTERRUPTION, OR LOSS OF BUSINESS INFORMATION) ARISING OUT OF THE USE OF OR INABILITY TO USE THE PROGRAM, OR FOR ANY CLAIM BY ANY OTHER PARTY, EVEN IF ZyXEL HAS BEEN ADVISED OF THE POSSIBILITY OF SUCH DAMAGES. ZyXEL'S AGGREGATE LIABILITY WITH RESPECT TO ITS OBLIGATIONS UNDER THIS AGREEMENT OR OTHERWISE WITH RESPECT TO THE SOFTWARE AND DOCUMENTATION OR OTHERWISE SHALL BE EQUAL TO THE PURCHASE PRICE, BUT SHALL IN NO EVENT EXCEED THE PRODUCT'S PRICE. BECAUSE SOME STATES/COUNTRIES DO NOT ALLOW THE EXCLUSION OR LIMITATION OF LIABILITY FOR CONSEQUENTIAL OR INCIDENTAL DAMAGES, THE ABOVE LIMITATION MAY NOT APPLY TO YOU.

8. Export Restrictions

THIS LICENSE AGREEMENT IS EXPRESSLY MADE SUBJECT TO ANY APPLICABLE LAWS, REGULATIONS, ORDERS, OR OTHER RESTRICTIONS ON THE EXPORT OF THE SOFTWARE OR INFORMATION ABOUT SUCH SOFTWARE WHICH MAY BE IMPOSED FROM TIME TO TIME. YOU SHALL NOT EXPORT THE SOFTWARE, DOCUMENTATION OR INFORMATION ABOUT THE SOFTWARE AND DOCUMENTATION WITHOUT COMPLYING WITH SUCH LAWS, REGULATIONS, ORDERS, OR OTHER RESTRICTIONS. YOU AGREE TO INDEMNIFY ZyxEL AGAINST ALL CLAIMS, LOSSES, DAMAGES, LIABILITIES, COSTS AND EXPENSES, INCLUDING REASONABLE ATTORNEYS' FEES, TO THE EXTENT SUCH CLAIMS ARISE OUT OF ANY BREACH OF THIS SECTION 8.

9. Audit Rights

ZyxEL SHALL HAVE THE RIGHT, AT ITS OWN EXPENSE, UPON REASONABLE PRIOR NOTICE, TO PERIODICALLY INSPECT AND AUDIT YOUR RECORDS TO ENSURE YOUR COMPLIANCE WITH THE TERMS AND CONDITIONS OF THIS LICENSE AGREEMENT.

10. Termination

This License Agreement is effective until it is terminated. You may terminate this License Agreement at any time by destroying or returning to ZyxEL all copies of the Software and Documentation in your possession or under your control. ZyxEL may terminate this License Agreement for any reason, including, but not limited to, if ZyxEL finds that you have violated any of the terms of this License Agreement. Upon notification of termination, you agree to destroy or return to ZyxEL all copies of the Software and Documentation and to certify in writing that all known copies, including backup copies, have been destroyed. All provisions relating to confidentiality, proprietary rights, and non-disclosure shall survive the termination of this Software License Agreement.

11. General

This License Agreement shall be construed, interpreted and governed by the laws of Republic of China without regard to conflicts of laws provisions thereof. The exclusive forum for any disputes arising out of or relating to this License Agreement shall be an appropriate court or Commercial Arbitration Association sitting in ROC, Taiwan. This License Agreement shall constitute the entire Agreement between the parties hereto. This License Agreement, the rights granted hereunder, the Software and Documentation shall not be assigned by you without the prior written consent of ZyxEL. Any waiver or modification of this License Agreement shall only be effective if it is in writing and signed by both parties hereto. If any part of this License Agreement is found invalid or unenforceable by a court of competent jurisdiction, the remainder of this License Agreement shall be interpreted so as to reasonably effect the intention of the parties.

NOTE: Some components of this product incorporate source code covered under the open source code licenses. Further, for at least three (3) years from the date of distribution of the applicable product or software, we will give to anyone who contacts us at the ZyXEL Technical Support (support@zyxel.com.tw), for a charge of no more than our cost of physically performing source code distribution, a complete machine-readable copy of the complete corresponding source code for the version of the Programs that we distributed to you if we are in possession of such.

Notice

Information herein is subject to change without notice. Companies, names, and data used in examples herein are fictitious unless otherwise noted. No part may be reproduced or transmitted in any form or by any means, electronic or mechanical, for any purpose, except the express written permission of ZyXEL Communications Corporation.

This Product includes ntp software under the NTP License

NTP License

Copyright (c) David L. Mills 1992-2004

Permission to use, copy, modify, and distribute this software and its documentation for any purpose and without fee is hereby granted, provided that the above copyright notice appears in all copies and that both the copyright notice and this permission notice appear in supporting documentation, and that the name University of Delaware not be used in advertising or publicity pertaining to distribution of the software without specific, written prior permission. The University of Delaware makes no representations about the suitability this software for any purpose. It is provided "as is" without express or implied warranty.

This Product includes expat software under the Expat License

Expat License

Copyright (c) 1998, 1999, 2000 Thai Open Source Software Center Ltd

Permission is hereby granted, free of charge, to any person obtaining a copy of this software and associated documentation files (the "Software"), to deal in the Software without restriction, including

without limitation the rights to use, copy, modify, merge, publish, distribute, sublicense, and/or sell copies of the Software, and to permit persons to whom the Software is furnished to do so, subject to

the following conditions:

The above copyright notice and this permission notice shall be included in all copies or substantial portions of the Software.

THE SOFTWARE IS PROVIDED "AS IS", WITHOUT WARRANTY OF ANY KIND, EXPRESS OR IMPLIED, INCLUDING BUT NOT LIMITED TO THE WARRANTIES OF MERCHANTABILITY, FITNESS FOR A PARTICULAR PURPOSE AND NONINFRINGEMENT.

IN NO EVENT SHALL THE AUTHORS OR COPYRIGHT HOLDERS BE LIABLE FOR ANY CLAIM, DAMAGES OR OTHER LIABILITY, WHETHER IN AN ACTION OF CONTRACT, TORT OR OTHERWISE, ARISING FROM, OUT OF OR IN CONNECTION WITH THE SOFTWARE OR THE USE OR OTHER DEALINGS IN THE SOFTWARE.

an X11-style license

This is a Free Software License

This license is compatible with [The GNU General Public License, Version 1](#)

This license is compatible with [The GNU General Public License, Version 2](#)

This is just like a [Simple Permissive](#) license, but it requires that a copyright notice be maintained.

Permission is hereby granted, free of charge, to any person obtaining a copy of this software and associated documentation files (the "Software"), to deal in the Software without restriction, including without limitation the rights to use, copy, modify, merge, publish, distribute, sublicense, and/or sell copies of the Software, and to permit persons to whom the Software is furnished to do so, subject to the following conditions:

The above copyright notice and this permission notice shall be included in all copies or substantial portions of the Software.

This Product includes ppp-2.4.2 software under the PPP License

OpenSSL

LICENSE ISSUES

=====

The OpenSSL toolkit stays under a dual license, i.e. both the conditions of the OpenSSL License and the original SSLeay license apply to the toolkit. See below for the actual license texts. Actually both licenses are BSD-style Open Source licenses. In case of any license issues related to OpenSSL please contact openssl-core@openssl.org.

OpenSSL License

```
-----  
  
/*  
=====
```

* Copyright (c) 1998-2008 The OpenSSL Project. All rights reserved.

*

* Redistribution and use in source and binary forms, with or without
* modification, are permitted provided that the following conditions
* are met:

*

* 1. Redistributions of source code must retain the above copyright
* notice, this list of conditions and the following disclaimer.

*

* 2. Redistributions in binary form must reproduce the above copyright
* notice, this list of conditions and the following disclaimer in
* the documentation and/or other materials provided with the
* distribution.

*

* 3. All advertising materials mentioning features or use of this
* software must display the following acknowledgment:
* "This product includes software developed by the OpenSSL Project
* for use in the OpenSSL Toolkit. (<http://www.openssl.org/>)"

*

* 4. The names "OpenSSL Toolkit" and "OpenSSL Project" must not be used to
* endorse or promote products derived from this software without
* prior written permission. For written permission, please contact
* openssl-core@openssl.org.

- *
* 5. Products derived from this software may not be called "OpenSSL"
* nor may "OpenSSL" appear in their names without prior written
* permission of the OpenSSL Project.
*
* 6. Redistributions of any form whatsoever must retain the following
* acknowledgment:
* "This product includes software developed by the OpenSSL Project
* for use in the OpenSSL Toolkit (<http://www.openssl.org/>)"
*
* THIS SOFTWARE IS PROVIDED BY THE OpenSSL PROJECT ``AS IS'' AND ANY
* EXPRESSED OR IMPLIED WARRANTIES, INCLUDING, BUT NOT LIMITED TO, THE
* IMPLIED WARRANTIES OF MERCHANTABILITY AND FITNESS FOR A
PARTICULAR
* PURPOSE ARE DISCLAIMED. IN NO EVENT SHALL THE OpenSSL PROJECT OR
* ITS CONTRIBUTORS BE LIABLE FOR ANY DIRECT, INDIRECT, INCIDENTAL,
* SPECIAL, EXEMPLARY, OR CONSEQUENTIAL DAMAGES (INCLUDING, BUT
* NOT LIMITED TO, PROCUREMENT OF SUBSTITUTE GOODS OR SERVICES;
* LOSS OF USE, DATA, OR PROFITS; OR BUSINESS INTERRUPTION)
* HOWEVER CAUSED AND ON ANY THEORY OF LIABILITY, WHETHER IN
CONTRACT,
* STRICT LIABILITY, OR TORT (INCLUDING NEGLIGENCE OR OTHERWISE)
* ARISING IN ANY WAY OUT OF THE USE OF THIS SOFTWARE, EVEN IF ADVISED
* OF THE POSSIBILITY OF SUCH DAMAGE.
*
=====

```
*  
  
* This product includes cryptographic software written by Eric Young  
* (eay@cryptsoft.com). This product includes software written by Tim  
* Hudson (tjh@cryptsoft.com).  
  
*  
  
*/  
  
Original SSLeay License  
-----  
  
/* Copyright (C) 1995-1998 Eric Young (eay@cryptsoft.com)  
  
* All rights reserved.  
  
*  
  
* This package is an SSL implementation written  
  
* by Eric Young (eay@cryptsoft.com).  
  
* The implementation was written so as to conform with Netscapes SSL.  
  
*  
  
* This library is free for commercial and non-commercial use as long as  
* the following conditions are aheared to. The following conditions  
* apply to all code found in this distribution, be it the RC4, RSA,  
* lhash, DES, etc., code; not just the SSL code. The SSL documentation  
* included with this distribution is covered by the same copyright terms  
* except that the holder is Tim Hudson (tjh@cryptsoft.com).  
  
*  
  
* Copyright remains Eric Young's, and as such any Copyright notices in  
* the code are not to be removed.  
  
* If this package is used in a product, Eric Young should be given attribution
```

- * as the author of the parts of the library used.
- * This can be in the form of a textual message at program startup or
- * in documentation (online or textual) provided with the package.
- *
- * Redistribution and use in source and binary forms, with or without
- * modification, are permitted provided that the following conditions
- * are met:
- * 1. Redistributions of source code must retain the copyright
- * notice, this list of conditions and the following disclaimer.
- * 2. Redistributions in binary form must reproduce the above copyright
- * notice, this list of conditions and the following disclaimer in the
- * documentation and/or other materials provided with the distribution.
- * 3. All advertising materials mentioning features or use of this software
- * must display the following acknowledgement:
- * "This product includes cryptographic software written by
- * Eric Young (eay@cryptsoft.com)"
- * The word 'cryptographic' can be left out if the routines from the library
- * being used are not cryptographic related :-).
- * 4. If you include any Windows specific code (or a derivative thereof) from
- * the apps directory (application code) you must include an acknowledgement:
- * "This product includes software written by Tim Hudson (tjh@cryptsoft.com)"
- *
- * THIS SOFTWARE IS PROVIDED BY ERIC YOUNG ``AS IS'' AND
- * ANY EXPRESS OR IMPLIED WARRANTIES, INCLUDING, BUT NOT LIMITED TO,
- THE

- * IMPLIED WARRANTIES OF MERCHANTABILITY AND FITNESS FOR A PARTICULAR PURPOSE
- * ARE DISCLAIMED. IN NO EVENT SHALL THE AUTHOR OR CONTRIBUTORS BE LIABLE
- * FOR ANY DIRECT, INDIRECT, INCIDENTAL, SPECIAL, EXEMPLARY, OR CONSEQUENTIAL
- * DAMAGES (INCLUDING, BUT NOT LIMITED TO, PROCUREMENT OF SUBSTITUTE GOODS
- * OR SERVICES; LOSS OF USE, DATA, OR PROFITS; OR BUSINESS INTERRUPTION)
- * HOWEVER CAUSED AND ON ANY THEORY OF LIABILITY, WHETHER IN CONTRACT, STRICT
- * LIABILITY, OR TORT (INCLUDING NEGLIGENCE OR OTHERWISE) ARISING IN ANY WAY
- * OUT OF THE USE OF THIS SOFTWARE, EVEN IF ADVISED OF THE POSSIBILITY OF
- * SUCH DAMAGE.
- *
- * The licence and distribution terms for any publically available version or
- * derivative of this code cannot be changed. i.e. this code cannot simply be
- * copied and put under another distribution licence
- *

This Product includes libevent and xinetd software under the a 3-clause BSD License

a 3-clause BSD-style license

This is a Free Software License

This license is compatible with [The GNU General Public License, Version 1](#)

This license is compatible with [The GNU General Public License, Version 2](#)

This is the BSD license without the obnoxious advertising clause. It's also known as the "modified BSD license." Note that the University of California now prefers this license to the BSD license with advertising clause, and now allows BSD itself to be used under the three-clause license.

Redistribution and use in source and binary forms, with or without modification, are permitted provided that the following conditions are met:

- Redistributions of source code must retain the above copyright notice, this list of conditions and the following disclaimer.
- Redistributions in binary form must reproduce the above copyright notice, this list of conditions and the following disclaimer in the documentation and/or other materials provided with the distribution.
- Neither the name of [original copyright holder] nor the names of its contributors may be used to endorse or promote products derived from this software without specific prior written permission.

THIS SOFTWARE IS PROVIDED BY THE COPYRIGHT HOLDERS AND CONTRIBUTORS "AS IS" AND ANY EXPRESS OR IMPLIED WARRANTIES, INCLUDING, BUT NOT LIMITED TO, THE IMPLIED WARRANTIES OF MERCHANTABILITY AND FITNESS FOR A PARTICULAR PURPOSE ARE DISCLAIMED. IN NO EVENT SHALL THE COPYRIGHT OWNER OR CONTRIBUTORS BE LIABLE FOR ANY DIRECT, INDIRECT, INCIDENTAL, SPECIAL, EXEMPLARY, OR CONSEQUENTIAL DAMAGES (INCLUDING, BUT NOT LIMITED TO, PROCUREMENT OF SUBSTITUTE GOODS OR SERVICES; LOSS OF USE, DATA, OR PROFITS; OR BUSINESS INTERRUPTION) HOWEVER CAUSED AND ON ANY THEORY OF LIABILITY, WHETHER IN CONTRACT, STRICT LIABILITY, OR TORT (INCLUDING NEGLIGENCE OR OTHERWISE) ARISING IN ANY WAY OUT OF THE USE OF THIS SOFTWARE, EVEN IF ADVISED OF THE POSSIBILITY OF SUCH DAMAGE.

This Product includes bind and dhcp software under the ISC License

ISC license

Copyright (c) 4-digit year, Company or Person's Name

Permission to use, copy, modify, and distribute this software for any purpose with or without fee is hereby granted, provided that the above copyright notice and this permission notice appear in all copies.

THE SOFTWARE IS PROVIDED "AS IS" AND ISC DISCLAIMS ALL WARRANTIES WITH REGARD TO THIS SOFTWARE INCLUDING ALL IMPLIED WARRANTIES OF MERCHANTABILITY AND FITNESS. IN NO EVENT SHALL ISC BE LIABLE FOR ANY SPECIAL, DIRECT, INDIRECT, OR CONSEQUENTIAL DAMAGES OR ANY DAMAGES WHATSOEVER RESULTING FROM LOSS OF USE, DATA OR PROFITS, WHETHER IN AN ACTION OF CONTRACT, NEGLIGENCE OR OTHER TORTIOUS ACTION, ARISING

OUT OF OR IN CONNECTION WITH THE USE OR PERFORMANCE OF THIS SOFTWARE.

This Product includes httpd software developed by the Apache Software Foundation under Apache License.

Apache License

Version 2.0, January 2004

<http://www.apache.org/licenses/>

TERMS AND CONDITIONS FOR USE, REPRODUCTION, AND DISTRIBUTION

1. Definitions.

"License" shall mean the terms and conditions for use, reproduction, and distribution as defined by Sections 1 through 9 of this document.

"Licensor" shall mean the copyright owner or entity authorized by the copyright owner that is granting the License.

"Legal Entity" shall mean the union of the acting entity and all other entities that control, are controlled by, or are under common control with that entity. For the purposes of this definition, "control" means (i) the power, direct or indirect, to cause the direction or management of such entity, whether by contract or otherwise, or (ii) ownership of fifty percent (50%) or more of the outstanding shares, or (iii) beneficial ownership of such entity.

"You" (or "Your") shall mean an individual or Legal Entity exercising permissions granted by this License.

"Source" form shall mean the preferred form for making modifications, including but not limited to software source code, documentation source, and configuration files.

"Object" form shall mean any form resulting from mechanical transformation or translation of a Source form, including but not limited to compiled object code, generated documentation, and conversions to other media types.

"Work" shall mean the work of authorship, whether in Source or Object form, made available under the License, as indicated by a copyright notice that is included in or attached to the work (an example is provided in the Appendix below).

"Derivative Works" shall mean any work, whether in Source or Object form, that is based on (or derived from) the Work and for which the editorial revisions, annotations, elaborations, or other modifications represent, as a whole, an original

work of authorship. For the purposes of this License, Derivative Works shall not include works that remain separable from, or merely link (or bind by name) to the interfaces of, the Work and Derivative Works thereof.

"Contribution" shall mean any work of authorship, including the original version of the Work and any modifications or additions to that Work or Derivative Works thereof, that is intentionally submitted to Licensor for inclusion in the Work by the copyright owner or by an individual or Legal Entity authorized to submit on behalf of the copyright owner. For the purposes of this definition, "submitted" means any form of electronic, verbal, or written communication sent to the Licensor or its representatives, including but not limited to communication on electronic mailing lists, source code control systems, and issue tracking systems that are managed by, or on behalf of, the Licensor for the purpose of discussing and improving the Work, but excluding communication that is conspicuously marked or otherwise designated in writing by the copyright owner as "Not a Contribution."

"Contributor" shall mean Licensor and any individual or Legal Entity on behalf of whom a Contribution has been received by Licensor and subsequently incorporated within the Work.

2. Grant of Copyright License. Subject to the terms and conditions of this License, each Contributor hereby grants to You a perpetual, worldwide, non-exclusive, no-charge, royalty-free, irrevocable copyright license to reproduce, prepare Derivative Works of, publicly display, publicly perform, sublicense, and distribute the Work and such Derivative Works in Source or Object form.

3. Grant of Patent License. Subject to the terms and conditions of this License, each Contributor hereby grants to You a perpetual, worldwide, non-exclusive, no-charge, royalty-free, irrevocable (except as stated in this section) patent license to make, have made, use, offer to sell, sell, import, and otherwise transfer the Work, where such license applies only to those patent claims licensable by such Contributor that are necessarily infringed by their Contribution(s) alone or by combination of their Contribution(s) with the Work to which such Contribution(s) was submitted. If You institute patent litigation against any entity (including a cross-claim or counterclaim in a lawsuit) alleging that the Work or a Contribution incorporated within the Work constitutes direct or contributory patent infringement, then any patent licenses granted to You under this License for that Work shall terminate as of the date such litigation is filed.

4. Redistribution. You may reproduce and distribute copies of the Work or Derivative Works hereof in any medium, with or without modifications, and in Source or Object form, provided that You meet the following conditions:

(a) You must give any other recipients of the Work or Derivative Works a copy of this License; and

(b) You must cause any modified files to carry prominent notices stating that You changed the files; and

(c) You must retain, in the Source form of any Derivative Works that You distribute, all copyright, patent, trademark, and attribution notices from the Source form of the Work, excluding those notices that do not pertain to any part of the Derivative Works; and

(d) If the Work includes a "NOTICE" text file as part of its distribution, then any Derivative Works that You distribute must include a readable copy of the attribution notices contained within such NOTICE file, excluding those notices that do not pertain to any part of the Derivative Works, in at least one of the following places: within a NOTICE text file distributed as part of the Derivative Works; within the Source form or documentation, if provided along with the Derivative Works; or, within a display generated by the Derivative Works, if and wherever such third-party notices normally appear. The contents of the NOTICE file are for informational purposes only and do not modify the License. You may add Your own attribution notices within Derivative Works that You distribute, alongside or as an addendum to the NOTICE text from the Work, provided that such additional attribution notices cannot be construed as modifying the License. You may add Your own copyright statement to Your modifications and may provide additional or different license terms and conditions for use, reproduction, or distribution of Your modifications, or for any such Derivative Works as a whole, provided Your use, reproduction, and distribution of the Work otherwise complies with the conditions stated in this License.

5. Submission of Contributions. Unless You explicitly state otherwise, any Contribution intentionally submitted for inclusion in the Work by You to the Licensor shall be under the terms and conditions of this License, without any additional terms or conditions. Notwithstanding the above, nothing herein shall supersede or modify the terms of any separate license agreement you may have executed with Licensor regarding such Contributions.

6. Trademarks. This License does not grant permission to use the trade names, trademarks, service marks, or product names of the Licensor, except as required for reasonable and customary use in describing the origin of the Work and reproducing the content of the NOTICE file.

7. Disclaimer of Warranty. Unless required by applicable law or agreed to in writing, Licensor provides the Work (and each Contributor provides its Contributions) on an "AS IS" BASIS, WITHOUT WARRANTIES OR CONDITIONS OF ANY KIND, either express or implied, including, without limitation, any warranties or conditions of TITLE, NON-INFRINGEMENT, MERCHANTABILITY, or FITNESS FOR A PARTICULAR PURPOSE. You are solely responsible for determining the appropriateness of using or redistributing the Work and assume any risks associated with Your exercise of permissions under this License.

8. Limitation of Liability. In no event and under no legal theory, whether in tort (including negligence), contract, or otherwise, unless required by applicable law (such as deliberate and grossly negligent acts) or agreed to in writing, shall any Contributor be liable to You for damages, including any direct, indirect, special, incidental, or consequential damages of any character arising as a result of this License or out of the use or inability to use the Work (including but not limited to damages for loss of goodwill, work stoppage, computer failure or malfunction, or any and all other commercial damages or losses), even if such Contributor has been advised of the possibility of such damages.

9. Accepting Warranty or Additional Liability. While redistributing the Work or Derivative Works thereof, You may choose to offer, and charge a fee for, acceptance of support, warranty, indemnity, or other liability obligations and/or rights consistent with this License. However, in accepting such obligations, You may act only on Your own behalf and on Your sole responsibility, not on behalf of any other Contributor, and only if You agree to indemnify, defend, and hold each Contributor harmless for any liability incurred by, or claims asserted against, such Contributor by reason of your accepting any such warranty or additional liability.

END OF TERMS AND CONDITIONS

Version 1.1

Copyright (c) 1999-2003 The Apache Software Foundation. All rights reserved.

Redistribution and use in source and binary forms, with or without modification, are permitted provided that the following conditions are met:

Redistributions of source code must retain the above copyright notice, this list of conditions and the following disclaimer.

Redistributions in binary form must reproduce the above copyright notice, this list of conditions and the following disclaimer in the documentation and/or other materials provided with the distribution.

The end-user documentation included with the redistribution, if any, must include the following acknowledgment: `ïThis product includes software developed by the Apache Software Foundation (http://www.apache.org/).î Alternately, this acknowledgment may appear in the software itself, if and wherever such third-party acknowledgments normally appear.`

The names `ïApacheî` and `ïApache Software Foundationî` must not be used to endorse or promote products derived from this software without prior written permission. For written permission, please contact apache@apache.org.

Products derived from this software may not be called `ïApacheî`, nor may `ïApacheî` appear in their name, without prior written permission of the Apache Software Foundation.

THIS SOFTWARE IS PROVIDED ``AS IS'' AND ANY EXPRESSED OR IMPLIED WARRANTIES, INCLUDING, BUT NOT LIMITED TO, THE IMPLIED WARRANTIES OF MERCHANTABILITY AND FITNESS FOR A PARTICULAR PURPOSE ARE DISCLAIMED. IN NO EVENT SHALL THE APACHE SOFTWARE FOUNDATION OR ITS CONTRIBUTORS BE LIABLE FOR ANY DIRECT, INDIRECT, INCIDENTAL, SPECIAL, EXEMPLARY, OR CONSEQUENTIAL DAMAGES (INCLUDING, BUT NOT LIMITED TO, PROCUREMENT OF SUBSTITUTE GOODS OR SERVICES; LOSS OF USE, DATA, OR PROFITS; OR BUSINESS INTERRUPTION) HOWEVER CAUSED AND ON ANY THEORY OF LIABILITY, WHETHER IN CONTRACT, STRICT LIABILITY, OR TORT (INCLUDING NEGLIGENCE OR OTHERWISE) ARISING IN ANY WAY OUT OF THE USE OF THIS SOFTWARE, EVEN IF ADVISED OF THE POSSIBILITY OF SUCH DAMAGE.

This software consists of voluntary contributions made by many individuals on behalf of the Apache Software Foundation. For more information on the Apache Software Foundation, please see <<http://www.apache.org/>>.

Portions of this software are based upon public domain software originally written at the National Center for Supercomputing Applications, University of Illinois, Urbana-Champaign.

GNU LESSER GENERAL PUBLIC LICENSE

Version 2.1, February 1999

Copyright (C) 1991, 1999 Free Software Foundation, Inc.

59 Temple Place, Suite 330, Boston, MA 02111-1307 USA

Everyone is permitted to copy and distribute verbatim copies of this license document, but changing it is not allowed. [This is the first released version of the Lesser GPL. It also counts

as the successor of the GNU Library Public License, version 2, hence the version number 2.1.

Preamble

The licenses for most software are designed to take away your freedom to share and change it. By contrast, the GNU General Public Licenses are intended to guarantee your freedom to share and change free software--to make sure the software is free for all its users.

This license, the Lesser General Public License, applies to some specially designated software packages--typically libraries--of the Free Software Foundation and other authors who decide to use it. You can use it too, but we suggest you first think carefully about whether this license or the ordinary General

Public License is the better strategy to use in any particular case, based on the explanations below.

When we speak of free software, we are referring to freedom of use, not price. Our General Public Licenses are designed to make sure that you have the freedom to distribute copies of free software (and charge for this service if you wish); that you receive source code or can get

it if you want it; that you can change the software and use pieces of it in new free programs; and that you are informed that you can do these things.

To protect your rights, we need to make restrictions that forbid distributors to deny you these rights or to ask you to surrender these rights. These restrictions translate to certain responsibilities for you if you distribute copies of the library or if you modify it.

For example, if you distribute copies of the library, whether gratis or for a fee, you must give the recipients all the rights that we gave you. You must make sure that they, too, receive or can get the source code. If you link other code with the library, you must provide complete object files to the recipients, so that they can relink them with the library after making changes to the library and recompiling it. And you must show them these terms so they know their rights.

We protect your rights with a two-step method: (1) we copyright the library, and (2) we offer you this license, which gives you legal permission to copy, distribute and/or modify the library.

To protect each distributor, we want to make it very clear that there is no warranty for the free library. Also, if the library is modified by someone else and passed on, the recipients should know that what they have is not the original version, so that the original author's reputation will not be affected by problems that might be introduced by others.

Finally, software patents pose a constant threat to the existence of any free program. We wish to make sure that a company cannot effectively restrict the users of a free program by obtaining a restrictive license from a patent holder. Therefore, we insist that any patent license obtained for a version of the library must be consistent with the full freedom of use specified in this license.

Most GNU software, including some libraries, is covered by the ordinary GNU General Public License. This license, the GNU Lesser General Public License, applies to certain designated libraries, and is quite different from the ordinary General Public License. We use this license for certain libraries in order to permit linking those libraries into non-free programs.

When a program is linked with a library, whether statically or using a shared library, the combination of the two is legally speaking a combined work, a

derivative of the original library. The ordinary General Public License therefore permits such linking only if the entire combination fits its criteria of freedom. The Lesser General Public License permits more lax criteria for linking other code with the library.

We call this license the "Lesser" General Public License because it does Less to protect the user's freedom than the ordinary General Public License. It also provides other free software developers Less of an advantage over competing non-free programs. These disadvantages are the reason we use the ordinary General Public License for many libraries. However, the Lesser license provides advantages in certain special circumstances.

For example, on rare occasions, there may be a special need to encourage the widest possible use of a certain library, so that it becomes a de-facto standard. To achieve this, non-free programs must be allowed to use the library. A more frequent case is that a free library does the same job as widely used non-free libraries. In this case, there is little to gain by limiting the free library to free software only, so we use the Lesser General Public License. In other cases, permission to use a particular library in non-free programs enables a greater number of people to use a large body of free software. For example, permission to use the GNU C Library in non-free programs enables many more people to use the whole GNU operating system, as well as its variant, the GNU/Linux operating system.

Although the Lesser General Public License is Less protective of the users' freedom, it does ensure that the user of a program that is linked with the Library has the freedom and the wherewithal to run that program using a modified version of the Library.

The precise terms and conditions for copying, distribution and modification follow. Pay close attention to the difference between a "work based on the library" and a "work that uses the library". The former contains code derived from the library, whereas the latter must be combined with the library in order to run.

GNU LESSER GENERAL PUBLIC LICENSE TERMS AND CONDITIONS FOR COPYING, DISTRIBUTION AND MODIFICATION

0. This License Agreement applies to any software library or other program which contains a notice placed by the copyright holder or other authorized party saying it may be distributed under the terms of this Lesser General Public License (also called "this License").

Each licensee is addressed as "you".

A "library" means a collection of software functions and/or data prepared so as to be conveniently linked with application programs (which use some of those functions and data) to form executables. The "Library", below, refers to any such

software library or work which has been distributed under these terms. A "work based on the Library" means either the Library or any derivative work under copyright law: that is to say, a work containing the Library or a portion of it, either verbatim or with modifications and/or translated straightforwardly into another language. (Hereinafter, translation is included without limitation in the term "modification".)

"Source code" for a work means the preferred form of the work for making modifications to it. For a library, complete source code means all the source code for all modules it contains, plus any associated interface definition files, plus the scripts used to control compilation and installation of the library. Activities other than copying, distribution and modification are not covered by this License; they are outside its scope. The act of running a program using the Library is not restricted, and output from such a program is covered only if its contents constitute a work based on the Library (independent of the use of the Library in a tool for writing it). Whether that is true depends on what the Library does and what the program that uses the Library does.

1. You may copy and distribute verbatim copies of the Library's complete source code as you receive it, in any medium, provided that you conspicuously and appropriately publish on each copy an appropriate copyright notice and disclaimer of warranty; keep intact all the notices that refer to this License and to the absence of any warranty; and distribute a copy of this License along with the Library. You may charge a fee for the physical act of transferring a copy, and you may at your option offer warranty protection in exchange for a fee.
2. You may modify your copy or copies of the Library or any portion of it, thus forming a work based on the Library, and copy and distribute such modifications or work under the terms of Section 1 above, provided that you also meet all of these conditions: a) The modified work must itself be a software library. b) You must cause the files modified to carry prominent notices stating that you changed the files and the date of any change. c) You must cause the whole of the work to be licensed at no charge to all third parties under the terms of this License. d) If a facility in the modified Library refers to a function or a table of data to be supplied by an application program that uses the facility, other than as an argument passed when the facility is invoked, then you must make a good faith effort to ensure that, in the event an application does not supply such function or table, the facility still operates, and performs whatever part of its purpose remains meaningful. (For example, a function in a library to compute square roots has a purpose that is entirely well-defined independent of the application. Therefore, Subsection 2d requires that any application-supplied function or table used by this function must be optional: if the application does not supply it, the square root function must still compute square roots.) These requirements apply to the modified work as a whole. If identifiable sections of that work are not derived from the Library, and can be reasonably considered independent and separate works in themselves, then this License, and its terms, do not apply to those sections when you distribute them as separate works. But when you distribute the same sections as

part of a whole which is a work based on the Library, the distribution of the whole must be on the terms of this License, whose permissions for other licensees extend to the entire whole, and thus to each and every part regardless of who wrote

it. Thus, it is not the intent of this section to claim rights or contest your rights to work written entirely by you; rather, the intent is to exercise the right to control the distribution of derivative or collective works based on the Library. In addition, mere aggregation of another work not based on the Library with the Library (or with a work based on the Library) on a volume of a storage or distribution medium does not bring the other work under the scope of this License.

3. You may opt to apply the terms of the ordinary GNU General Public License instead of this License to a given copy of the Library. To do this, you must alter all the notices that refer to this License, so that they refer to the ordinary GNU General Public License, version 2, instead of to this License. (If a newer version than version 2 of the ordinary GNU General Public License has appeared, then you can specify that version instead if you wish.) Do not make any other change in these notices. Once this change is made in a given copy, it is irreversible for that copy, so the ordinary GNU General Public License applies to all subsequent copies and derivative works made from that copy. This option is useful when you wish to copy part of the code of the Library into a program that is not a library.

4. You may copy and distribute the Library (or a portion or derivative of it, under Section 2) in object code or executable form under the terms of Sections 1 and 2 above provided that you accompany it with the complete corresponding machine-readable source code, which must be distributed under the terms of Sections 1 and 2 above on a medium customarily used for software interchange. If distribution of object code is made by offering access to copy from a designated place, then offering equivalent access to copy the source code from the same place satisfies the requirement to distribute the source code, even though third parties are not

compelled to copy the source along with the object code.

5. A program that contains no derivative of any portion of the Library, but is designed to work with the Library by being compiled or linked with it, is called a "work that uses the Library". Such a work, in isolation, is not a derivative work of the Library, and therefore falls outside the scope of this License.

However, linking a "work that uses the Library" with the Library creates an executable that is a derivative of the Library (because it contains portions of the Library), rather than a "work that uses the library". The executable is therefore covered by this License. Section 6 states terms for distribution of such executables. When a "work that uses the Library" uses material from a header file that is part of the Library, the object code for the work may be a derivative work of the Library even though the source code is not. Whether this is true is especially

significant if the work can be linked without the Library, or if the work is itself a library. The threshold for this to be true is not precisely defined by law. If such an object file uses only numerical parameters, data structure layouts and accessors, and small macros and small inline functions (ten lines or less in length), then the use of the object file is unrestricted, regardless of whether it is legally a derivative work. (Executables containing this object code plus portions of the Library will still fall under Section 6.) Otherwise, if the work is a derivative of the Library, you may distribute the object code for the work under the terms of Section 6. Any executables containing that work also fall under Section 6, whether or not they are linked directly with the Library itself.

6. As an exception to the Sections above, you may also combine or link a "work that uses the Library" with the Library to produce a work containing portions of the Library, and distribute that work under terms of your choice, provided that the terms permit modification of the work for the customer's own use and reverse engineering for debugging such modifications. You must give prominent notice with each copy of the work that the Library is used in it and that the Library and its use are covered by this License. You must supply a copy of this License. If the work during execution displays copyright notices, you must include the copyright notice for the Library among them, as well as a reference directing the user to the copy of this License. Also, you must do one of these things: a) Accompany the work with the complete corresponding

machine-readable source code for the Library including whatever changes were used in the work (which must be distributed under Sections 1 and 2 above); and, if the work is an executable linked with the Library, with the complete machine-readable "work that uses the Library", as object code and/or source code, so that the user can modify the Library and then relink to produce a modified executable containing the modified Library. (It is understood that the user who changes the contents of definitions files in the Library will not necessarily be able to recompile the application to use the modified definitions.) b) Use a suitable shared library mechanism for linking with the Library. A suitable mechanism is one that (1) uses at run time a

copy of the library already present on the user's computer system, rather than copying library functions into the executable, and (2) will operate properly with a modified version of the library, if the user installs one, as long as the modified version is interface-compatible with the version that the work was made with. c) Accompany the work with a written offer, valid for at least three years, to give the same user the materials specified in Subsection 6a, above, for a charge no more than the cost of performing this distribution. d) If distribution of the work is made by offering access to copy from a designated place, offer equivalent access to copy the above specified materials from the same place. e) Verify that the user has already received a copy of these materials or that you have already sent this user a copy. For an executable, the required form of the "work that uses the Library" must include any data and utility programs needed for reproducing the executable from it. However, as a special exception, the materials to be distributed need not

include anything that is normally distributed (in either source or binary form) with the major components (compiler, kernel, and so on) of the operating system on which the executable runs, unless that component itself accompanies the executable.

It may happen that this requirement contradicts the license restrictions of other proprietary libraries that do not normally accompany the operating system. Such a contradiction means you cannot use both them and the Library together in an executable that you distribute.

7. You may place library facilities that are a work based on the Library side-by-side in a single library together with other library facilities not covered by this License, and distribute such a combined library, provided that the separate distribution of the work based on the Library and of the other library facilities is otherwise permitted, and provided that you do these two things: a) Accompany the combined library with a copy of the same work based on the Library, uncombined with any other library facilities. This must be distributed under the terms of the Sections above. b) Give prominent notice with the combined library of the fact that part of it is a work based on the Library, and explaining where to find the accompanying uncombined form of the same work.

8. You may not copy, modify, sublicense, link with, or distribute the Library except as expressly provided under this License. Any attempt otherwise to copy, modify, sublicense, link with, or distribute the Library is void, and will automatically terminate your rights under this License. However, parties who have received copies, or rights, from you under this License will not have their licenses terminated so long as such parties remain in full compliance.

9. You are not required to accept this License, since you have not signed it. However, nothing else grants you permission to modify or distribute the Library or its derivative works. These actions are prohibited by law if you do not accept this License. Therefore, by modifying or distributing the Library (or any work based on the Library), you indicate your acceptance of this License to do so, and all its terms and conditions for copying, distributing or modifying the Library or works based on it.

10. Each time you redistribute the Library (or any work based on the Library), the recipient automatically receives a license from the original licensor to copy, distribute, link with or modify the Library subject to these terms and conditions. You may not impose any further restrictions on the recipients' exercise of the rights granted herein. You are not responsible for enforcing compliance by third parties with this License.

11. If, as a consequence of a court judgment or allegation of patent infringement or for any other reason (not limited to patent issues), conditions are imposed on you (whether by court order, agreement or otherwise) that contradict the conditions of this License, they do not excuse you from the conditions of this

License. If you cannot distribute so as to satisfy simultaneously your obligations under this License and any other pertinent obligations, then as a consequence you may not distribute the Library at all. For example, if a patent license would not permit royalty-free redistribution of the Library by all those who receive copies directly or indirectly through you, then the only way you could satisfy both it and this License would be to

refrain entirely from distribution of the Library. If any portion of this section is held invalid or unenforceable under any particular circumstance, the balance of the section is intended to apply, and the section as a whole is intended to apply in other circumstances. It is not the purpose of this section to induce you to infringe any patents or other property right claims or to contest validity of any such claims; this section has the sole purpose of protecting the integrity of the free software distribution system which is implemented by public license practices. Many people have made generous contributions to the wide range of software distributed through that system in reliance on consistent application of that system; it is up to the author/donor to decide if he or she is willing to distribute software through any other system and a licensee cannot impose that choice. This section is intended to make thoroughly clear what is believed to be a consequence of the rest of this License.

12. If the distribution and/or use of the Library is restricted in certain countries either by patents or by copyrighted interfaces, the original copyright holder who places the Library under this License may add an explicit geographical distribution limitation excluding those countries, so that distribution is permitted only in or among countries not thus excluded. In such case, this License incorporates the limitation as if written in the body of this License.

13. The Free Software Foundation may publish revised and/or new versions of the Lesser General Public License from time to time. Such new versions will be similar in spirit to the present version, but may differ in detail to address new problems or concerns. Each version is given a distinguishing version number. If the Library specifies a version number of this License which applies to it and "any later version", you have the option of following the terms and conditions either of that version or of any later version published by the Free Software Foundation. If the Library does not specify a license version number, you may choose any version ever published by the Free Software Foundation.

14. If you wish to incorporate parts of the Library into other free programs whose distribution conditions are incompatible with these, write to the author to ask for permission. For software which is copyrighted by the Free Software Foundation, write to the Free Software Foundation; we sometimes make exceptions for this. Our decision will be guided by the two goals of preserving the free status of all derivatives of our free software and of promoting the sharing

and reuse of software generally.

NO WARRANTY

15. BECAUSE THE LIBRARY IS LICENSED FREE OF CHARGE, THERE IS NO WARRANTY FOR THE LIBRARY, TO THE EXTENT PERMITTED BY APPLICABLE LAW. EXCEPT WHEN OTHERWISE STATED IN WRITING THE COPYRIGHT HOLDERS AND/OR OTHER PARTIES PROVIDE THE LIBRARY "AS IS" WITHOUT WARRANTY OF ANY KIND, EITHER EXPRESSED OR IMPLIED, INCLUDING, BUT NOT LIMITED TO, THE IMPLIED WARRANTIES OF MERCHANTABILITY AND FITNESS FOR A PARTICULAR PURPOSE. THE ENTIRE RISK AS TO THE QUALITY AND PERFORMANCE OF THE LIBRARY IS WITH YOU. SHOULD THE LIBRARY PROVE DEFECTIVE, YOU ASSUME THE COST OF ALL NECESSARY SERVICING, REPAIR OR CORRECTION.

16. IN NO EVENT UNLESS REQUIRED BY APPLICABLE LAW OR AGREED TO IN WRITING WILL ANY COPYRIGHT HOLDER, OR ANY OTHER PARTY WHO MAY MODIFY AND/OR REDISTRIBUTE THE LIBRARY AS PERMITTED ABOVE, BE LIABLE TO YOU FOR DAMAGES, INCLUDING ANY GENERAL, SPECIAL, INCIDENTAL OR CONSEQUENTIAL DAMAGES ARISING OUT OF THE USE OR INABILITY TO USE THE LIBRARY (INCLUDING BUT NOT LIMITED TO LOSS OF DATA OR DATA BEING RENDERED INACCURATE OR LOSSES SUSTAINED BY YOU OR THIRD PARTIES OR A FAILURE OF THE LIBRARY TO OPERATE WITH ANY OTHER SOFTWARE), EVEN IF SUCH HOLDER OR OTHER PARTY HAS BEEN ADVISED OF THE POSSIBILITY OF SUCH DAMAGES.

END OF TERMS AND CONDITIONS.

This Product includes arp-sk, bridge-utils, busybox, dhcpd, dhcp-helper, gd, libqsearch, ipset, samba, libeeprog, msmtmp, pam, pptp, ppp, proftpd, rp-pppoe, vlan, syslog-ng, tzcode, quagga, iproute2, iptables, Linux kernel, pcmcia, netkit-telnet and libol software under GPL license.

GNU GENERAL PUBLIC LICENSE

Version 2, June 1991

Copyright (C) 1989, 1991 Free Software Foundation, Inc.

59 Temple Place - Suite 330, Boston, MA 02111-1307, USA

Everyone is permitted to copy and distribute verbatim copies of this license document, but changing it is not allowed.

Preamble

The licenses for most software are designed to take away your freedom to share and change it. By contrast, the GNU General Public License is intended to guarantee your freedom to share and change free software--to make sure the software is free for all its users. This General Public License applies to most of the Free Software Foundation's software and to any other program whose authors

commit to using it. (Some other Free Software Foundation software is covered by the GNU Library General Public License instead.) You can apply it to your programs, too.

When we speak of free software, we are referring to freedom, not price. Our General Public Licenses are designed to make sure that you have the freedom to distribute copies of free software (and charge for this service if you wish), that you receive source code or can get it if you want it, that you can change the software or use pieces of it in new free programs; and that you know you can do these things.

To protect your rights, we need to make restrictions that forbid anyone to deny you these rights or to ask you to surrender the rights. These restrictions translate to certain responsibilities for you if you distribute copies of the software, or if you modify it. For example, if you distribute copies of such a program, whether gratis or for a fee, you must give the recipients all the rights that you have. You must make sure that they, too, receive or can get the source code. And you must show them these terms so they know their rights.

We protect your rights with two steps: (1) copyright the software, and (2) offer you this license which gives you legal permission to copy, distribute and/or modify the software. Also, for each author's protection and ours, we want to make certain that everyone understands that there is no warranty for this free software. If the software is modified by someone else and passed on, we want its recipients to know that what they have is not the original, so that any problems introduced by others will not reflect on the original authors' reputations.

Finally, any free program is threatened constantly by software patents. We wish to avoid the danger that redistributors of a free program will individually obtain patent licenses, in effect making the program proprietary. To prevent this, we have made it clear that any patent must be licensed for everyone's free use or not licensed at all.

The precise terms and conditions for copying, distribution and modification follow.

TERMS AND CONDITIONS FOR COPYING, DISTRIBUTION AND MODIFICATION

0. This License applies to any program or other work which contains a notice placed by the copyright holder saying it may be distributed under the terms of this General Public License. The "Program", below, refers to any such program or work, and a "work based on the Program" means either the Program or any derivative work under copyright law: that is to say, a work containing the Program or a portion of it, either verbatim or with modifications and/or translated into another language. (Hereinafter, translation is included without limitation in the term "modification".) Each licensee is addressed as "you". Activities other than

copying, distribution and modification are not covered by this License; they are outside its scope. The act of running the Program is not restricted, and the output from the Program is covered only if its contents constitute a work based on the Program (independent of having been made by running the Program). Whether that is true depends on what the Program does.

1. You may copy and distribute verbatim copies of the Program's source code as you receive it, in any medium, provided that you conspicuously and appropriately publish on each copy an appropriate copyright notice and disclaimer of warranty; keep intact all the notices that refer to this License and to the absence of any warranty; and give any other recipients of the Program a copy of this License along with the Program. You may charge a fee for the physical act of transferring a copy, and you may at your option offer warranty protection in exchange for a fee.

2. You may modify your copy or copies of the Program or any portion of it, thus forming a work based on the Program, and copy and distribute such modifications or work under the terms of Section 1 above, provided that you also meet all of these conditions:

a) You must cause the modified files to carry prominent notices stating that you changed the files and the date of any change.

b) You must cause any work that you distribute or publish, that in whole or in part contains or is derived from the Program or any part thereof, to be licensed as a whole at no charge to all third parties under the terms of this License.

c) If the modified program normally reads commands interactively when run, you must cause it, when started running for such interactive use in the most ordinary way, to print or display an announcement including an appropriate copyright notice and a notice that there is no warranty (or else, saying that you provide a warranty) and that users may redistribute the program under these conditions, and telling the user how to view a copy of this License. (Exception: if the Program itself is interactive but does not normally print such an announcement, your work based on the Program is not required to print an announcement.)

These requirements apply to the modified work as a whole. If identifiable sections of that work are not derived from the Program, and can be reasonably considered independent and separate works in themselves, then this License, and its terms, do not apply to those sections when you distribute them as separate works. But when you distribute the same sections as part of a whole which is a work based on the Program, the distribution of the whole must be on the terms of this License, whose permissions for other licensees extend to the entire whole, and thus to each and every part regardless of who wrote it. Thus, it is not the intent of this section to claim rights or contest your rights to work written entirely by you; rather, the intent is to exercise the right to control the distribution of derivative or collective works based on the Program. In addition, mere aggregation of another work not based on the Program with the Program (or with a work based on the

Program) on a volume of a storage or distribution medium does not bring the other work under the scope of this License.

3. You may copy and distribute the Program (or a work based on it, under Section 2) in object code or executable form under the terms of Sections 1 and 2 above provided that you also do one of the following:

a) Accompany it with the complete corresponding machine-readable source code, which must be distributed under the terms of Sections 1 and 2 above on a medium customarily used for software interchange; or,

b) Accompany it with a written offer, valid for at least three years, to give any third party, for a charge no more than your cost of physically performing source distribution, a complete machine-readable copy of the corresponding source code, to be distributed under the terms of Sections 1 and 2 above on a medium customarily used for software interchange; or, c) Accompany it with the information you received as to the offer to distribute corresponding source code. (This alternative is allowed only for noncommercial distribution and only if you received the program in object code or executable form with such an offer, in accord with Subsection b above.) The source code for a work means the preferred form of the work for making modifications to it. For an executable work, complete source code means all the source code for all modules it contains, plus any associated interface definition files, plus the

scripts used to control compilation and installation of the executable. However, as a special exception, the source code distributed need not include anything that is normally distributed (in either source or binary form) with the major components (compiler, kernel, and so on) of the operating system on which the executable runs, unless that component itself accompanies the executable. If distribution of executable or object code is made by offering access to copy from a designated place, then offering equivalent access to copy the source code from the same place counts as distribution of the source code, even though third parties are not compelled to copy the source along with the object code.

4. You may not copy, modify, sublicense, or distribute the Program except as expressly provided under this License. Any attempt otherwise to copy, modify, sublicense or distribute the Program is void, and will automatically terminate your rights under this License. However, parties who have received copies, or rights, from you under this License will not have their licenses terminated so long as such parties remain in full compliance.

5. You are not required to accept this License, since you have not signed it. However, nothing else grants you permission to modify or distribute the Program or its derivative works. These actions are prohibited by law if you do not accept this License. Therefore, by modifying or distributing the Program (or any work based on the Program), you indicate your acceptance of this License to do so, and

all its terms and conditions for copying, distributing or modifying the Program or works based on it.

6. Each time you redistribute the Program (or any work based on the Program), the recipient automatically receives a license from the original licensor to copy, distribute or modify the Program subject to these terms and conditions. You may not impose any further restrictions on the recipients' exercise of the rights granted herein. You are not responsible for enforcing compliance by third parties to this License.

7. If, as a consequence of a court judgment or allegation of patent infringement or for any other reason (not limited to patent issues), conditions are imposed on you (whether by court order, agreement or otherwise) that contradict the conditions of this License, they do not excuse you from the conditions of this License. If you cannot distribute so as to satisfy simultaneously your obligations under this License and any other pertinent obligations, then as a consequence you may not distribute the Program at all. For example, if a patent license would not permit royalty-free redistribution of the Program by all those who receive copies directly or indirectly through you, then the only way you could satisfy both it and this License would be to refrain entirely from distribution of the Program. If any portion of this section is held invalid or unenforceable under any particular circumstance, the balance of the section is intended to apply and the section as a whole is intended to apply in other circumstances. It is not the purpose of this section to induce you to infringe any patents or other property right claims or to contest validity of any such claims; this section has the sole purpose of protecting the integrity of the free software distribution system, which is implemented by public license practices. Many people have made generous contributions to the wide range of software distributed through that system in reliance on consistent application of that system; it is up to the author/donor to decide if he or she is willing to distribute software through any other system and a licensee cannot impose that choice. This section is intended to make thoroughly clear what is believed to be a consequence of the rest of this License.

8. If the distribution and/or use of the Program is restricted in certain countries either by patents or by copyrighted interfaces, the original copyright holder who places the Program under this License may add an explicit geographical distribution limitation excluding those countries, so that distribution is permitted only in or among countries not thus excluded. In such case, this License incorporates the limitation as if written in the body of this License.

9. The Free Software Foundation may publish revised and/or new versions of the General Public License from time to time. Such new versions will be similar in spirit to the present version, but may differ in detail to address new problems or concerns. Each version is given a distinguishing version number. If the Program specifies a version number of this License which applies to it and "any later version", you have the option of following the terms and conditions either of that version or of any later version published by the Free Software Foundation. If the

Program does not specify a version number of this License, you may choose any version ever published by the Free Software Foundation.

10. If you wish to incorporate parts of the Program into other free programs whose distribution conditions are different, write to the author to ask for permission. For software which is copyrighted by the Free Software Foundation, write to the Free Software Foundation; we sometimes make exceptions for this. Our decision will be guided by the two goals of preserving the free status of all derivatives of our free software and of promoting the sharing and reuse of software generally.

NO WARRANTY

11. BECAUSE THE PROGRAM IS LICENSED FREE OF CHARGE, THERE IS NO WARRANTY FOR THE PROGRAM, TO THE EXTENT PERMITTED BY APPLICABLE LAW. EXCEPT WHEN OTHERWISE STATED IN WRITING THE COPYRIGHT HOLDERS AND/OR OTHER PARTIES PROVIDE THE PROGRAM "AS IS" WITHOUT WARRANTY OF ANY KIND, EITHER EXPRESSED OR IMPLIED, INCLUDING, BUT NOT LIMITED TO, THE IMPLIED WARRANTIES OF MERCHANTABILITY AND FITNESS FOR A PARTICULAR PURPOSE. THE ENTIRE RISK AS TO THE QUALITY AND PERFORMANCE OF THE PROGRAM IS WITH YOU. SHOULD THE PROGRAM PROVE DEFECTIVE, YOU ASSUME THE COST OF ALL NECESSARY SERVICING, REPAIR OR CORRECTION.

12. IN NO EVENT UNLESS REQUIRED BY APPLICABLE LAW OR AGREED TO IN WRITING WILL ANY COPYRIGHT HOLDER, OR ANY OTHER PARTY WHO MAY MODIFY AND/OR REDISTRIBUTE THE PROGRAM AS PERMITTED ABOVE, BE LIABLE TO YOU FOR DAMAGES, INCLUDING ANY GENERAL, SPECIAL, INCIDENTAL OR CONSEQUENTIAL DAMAGES ARISING OUT OF THE USE OR INABILITY TO USE THE PROGRAM (INCLUDING BUT NOT LIMITED TO LOSS OF DATA OR DATA BEING RENDERED INACCURATE OR LOSSES SUSTAINED BY YOU OR THIRD PARTIES OR A FAILURE OF THE PROGRAM TO OPERATE WITH ANY OTHER PROGRAMS), EVEN IF SUCH HOLDER OR OTHER PARTY HAS BEEN ADVISED OF THE POSSIBILITY OF SUCH DAMAGES.

END OF TERMS AND CONDITIONS

All other trademarks or trade names mentioned herein, if any, are the property of their respective owners.

This Product includes ppp, libpcap, tcpdump, unzip, zip, libnet, net-snmp, openssh, and ftp-tls software under BSD license

BSD

Copyright (c) [dates as appropriate to package]

The Regents of the University of California. All rights reserved. Redistribution and use in source and binary forms, with or without modification, are permitted provided that the following conditions are met:

Redistributions of source code must retain the above copyright notice, this list of conditions and the following disclaimer.

Redistributions in binary form must reproduce the above copyright notice, this list of conditions and the following disclaimer in the documentation and/or other materials provided with the distribution.

Neither the name of the University nor of the Laboratory may be used to endorse or promote products derived from this software without specific prior written permission.

THIS SOFTWARE IS PROVIDED BY THE REGENTS AND CONTRIBUTORS ``AS IS'' AND ANY EXPRESS OR IMPLIED WARRANTIES, INCLUDING, BUT NOT LIMITED TO, THE IMPLIED WARRANTIES OF MERCHANTABILITY AND FITNESS FOR A PARTICULAR PURPOSE ARE DISCLAIMED. IN NO EVENT SHALL THE REGENTS OR CONTRIBUTORS BE LIABLE FOR ANY DIRECT, INDIRECT, INCIDENTAL, SPECIAL, EXEMPLARY, OR CONSEQUENTIAL DAMAGES (INCLUDING, BUT NOT LIMITED TO, PROCUREMENT OF SUBSTITUTE GOODS OR SERVICES; LOSS OF USE, DATA, OR PROFITS; OR BUSINESS INTERRUPTION) HOWEVER CAUSED AND ON ANY THEORY OF LIABILITY, WHETHER IN CONTRACT, STRICT LIABILITY, OR TORT (INCLUDING NEGLIGENCE OR OTHERWISE) ARISING IN ANY WAY OUT OF THE USE OF THIS SOFTWARE, EVEN IF ADVISED OF THE POSSIBILITY OF SUCH DAMAGE.

This Product includes libxml2, tablekit, prototype and persist-js software under the MIT License

The MIT License

Copyright (c) <year> <copyright holders>

Permission is hereby granted, free of charge, to any person obtaining a copy of this software and associated documentation files (the "Software"), to deal in the Software without restriction, including without limitation the rights to use, copy, modify, merge, publish, distribute, sublicense, and/or sell copies of the Software, and to permit persons to whom the Software is furnished to do so, subject to the following conditions:

The above copyright notice and this permission notice shall be included in all copies or substantial portions of the Software.

THE SOFTWARE IS PROVIDED "AS IS", WITHOUT WARRANTY OF ANY KIND, EXPRESS OR IMPLIED, INCLUDING BUT NOT LIMITED TO THE WARRANTIES OF MERCHANTABILITY, FITNESS FOR A PARTICULAR PURPOSE AND

NONINFRINGEMENT. IN NO EVENT SHALL THE AUTHORS OR COPYRIGHT HOLDERS BE LIABLE FOR ANY CLAIM, DAMAGES OR OTHER LIABILITY, WHETHER IN AN ACTION OF CONTRACT, TORT OR OTHERWISE, ARISING FROM, OUT OF OR IN CONNECTION WITH THE SOFTWARE OR THE USE OR OTHER DEALINGS IN THE SOFTWARE.

This Product includes openldap software under the OpenLdap License

The Public License

Version 2.8, 17 August 2003

Redistribution and use of this software and associated documentation("Software"), with or without modification, are permitted provided that the following conditions are met:

1. Redistributions in source form must retain copyright statements and notices,
2. Redistributions in binary form must reproduce applicable copyright statements and notices, this list of conditions, and the following disclaimer in the documentation and/or other materials provided with the distribution, and
3. Redistributions must contain a verbatim copy of this document.

The OpenLDAP Foundation may revise this license from time to time. Each revision is distinguished by a version number. You may use this Software under terms of this license revision or under the terms of any subsequent revision of the license.

THIS SOFTWARE IS PROVIDED BY THE OPENLDAP FOUNDATION AND ITS CONTRIBUTORS ``AS IS'' AND ANY EXPRESSED OR IMPLIED WARRANTIES, INCLUDING, BUT NOT LIMITED TO, THE IMPLIED WARRANTIES OF MERCHANTABILITY AND FITNESS FOR A PARTICULAR PURPOSE ARE DISCLAIMED. IN NO EVENT SHALL THE OPENLDAP FOUNDATION, ITS CONTRIBUTORS, OR THE AUTHOR(S) OR OWNER(S) OF THE SOFTWARE BE LIABLE FOR ANY DIRECT, INDIRECT, INCIDENTAL, SPECIAL, EXEMPLARY, OR CONSEQUENTIAL DAMAGES (INCLUDING, BUT NOT LIMITED TO, PROCUREMENT OF SUBSTITUTE GOODS OR SERVICES; LOSS OF USE, DATA, OR PROFITS; OR BUSINESS INTERRUPTION) HOWEVER CAUSED AND ON ANY THEORY OF LIABILITY, WHETHER IN CONTRACT, STRICT LIABILITY, OR TORT (INCLUDING NEGLIGENCE OR OTHERWISE) ARISING IN ANY WAY OUT OF THE USE OF THIS SOFTWARE, EVEN IF ADVISED OF THE POSSIBILITY OF SUCH DAMAGE.

The names of the authors and copyright holders must not be used in advertising or otherwise to promote the sale, use or other dealing in this Software without specific, written prior permission. Title to copyright in this Software shall at all times remain with copyright holders.

OpenLDAP is a registered trademark of the OpenLDAP Foundation.

Copyright 1999-2003 The OpenLDAP Foundation, Redwood City, California, USA. All Rights Reserved. Permission to copy and distribute verbatim copies of this document is granted.

This Product includes libpng software under the Libpng License

This copy of the libpng notices is provided for your convenience. In case of any discrepancy between this copy and the notices in the file png.h that is included in the libpng distribution, the latter shall prevail.

COPYRIGHT NOTICE, DISCLAIMER, and LICENSE:

If you modify libpng you may insert additional notices immediately following this sentence.

This code is released under the libpng license.

libpng versions 1.2.6, August 15, 2004, through 1.4.1, February 25, 2010, are

Copyright (c) 2004, 2006-2007 Glenn Randers-Pehrson, and are distributed according to the same disclaimer and license as libpng-1.2.5 with the following individual added to the list of Contributing Authors

Cosmin Truta

libpng versions 1.0.7, July 1, 2000, through 1.2.5 - October 3, 2002, are Copyright (c) 2000-2002 Glenn Randers-Pehrson, and are distributed according to the same disclaimer and license as libpng-1.0.6 with the following individuals added to the list of Contributing Authors

Simon-Pierre Cadieux

Eric S. Raymond

Gilles Vollant

and with the following additions to the disclaimer:

There is no warranty against interference with your enjoyment of the library or against infringement. There is no warranty that our efforts or the library will fulfill any of your particular purposes or needs. This library is provided with all faults, and the entire risk of satisfactory quality, performance, accuracy, and effort is with the user.

libpng versions 0.97, January 1998, through 1.0.6, March 20, 2000, are Copyright (c) 1998, 1999 Glenn Randers-Pehrson, and are distributed according to the same

disclaimer and license as libpng-0.96, with the following individuals added to the list of Contributing Authors:

Tom Lane
Glenn Randers-Pehrson
Willem van Schaik

libpng versions 0.89, June 1996, through 0.96, May 1997, are Copyright (c) 1996, 1997 Andreas Dilger Distributed according to the same disclaimer and license as libpng-0.88, with the following individuals added to the list of Contributing Authors:

John Bowler
Kevin Bracey
Sam Bushell
Magnus Holmgren
Greg Roelofs
Tom Tanner

libpng versions 0.5, May 1995, through 0.88, January 1996, are Copyright (c) 1995, 1996 Guy Eric Schalnat, Group 42, Inc.

For the purposes of this copyright and license, "Contributing Authors" is defined as the following set of individuals:

Andreas Dilger
Dave Martindale
Guy Eric Schalnat
Paul Schmidt
Tim Wegner

The PNG Reference Library is supplied "AS IS". The Contributing Authors and Group 42, Inc. disclaim all warranties, expressed or implied, including, without limitation, the warranties of merchantability and of fitness for any purpose. The Contributing Authors and Group 42, Inc. assume no liability for direct, indirect, incidental, special, exemplary, or consequential damages, which may result from the use of the PNG

Reference Library, even if advised of the possibility of such damage.

Permission is hereby granted to use, copy, modify, and distribute this source code, or portions hereof, for any purpose, without fee, subject to the following restrictions:

1. The origin of this source code must not be misrepresented.

2. Altered versions must be plainly marked as such and must not be misrepresented as being the original source.
3. This Copyright notice may not be removed or altered from any source or altered source distribution.

The Contributing Authors and Group 42, Inc. specifically permit, without fee, and encourage the use of this source code as a component to supporting the PNG file format in commercial products. If you use this source code in a product, acknowledgment is not required but would be appreciated.

A "png_get_copyright" function is available, for convenient use in "about" boxes and the like:

```
printf("%s",png_get_copyright(NULL));
```

Also, the PNG logo (in PNG format, of course) is supplied in the files "pngbar.png" and "pngbar.jpg (88x31) and "pngnow.png" (98x31).

Libpng is OSI Certified Open Source Software. OSI Certified Open Source is a certification mark of the Open Source Initiative.

Glenn Randers-Pehrson

glennrp at users.sourceforge.net

February 25, 2010

This Product includes libmd5-rfc software under the Zlib/libpng License

Copyright (c) <year> <copyright holders>

This software is provided 'as-is', without any express or implied warranty. In no event will the authors be held liable for any damages arising from the use of this software.

Permission is granted to anyone to use this software for any purpose, including commercial applications, and to alter it and redistribute it freely, subject to the following restrictions:

1. The origin of this software must not be misrepresented; you must not claim that you wrote the original software. If you use this software in a product, an acknowledgment in the product documentation would be appreciated but is not required.
2. Altered source versions must be plainly marked as such, and must not be misrepresented as being the original software.
3. This notice may not be removed or altered from any source distribution.

This Product includes pcmcia-cs software under the MPL License

Mozilla Public License Version 1.1

1. Definitions.

1.0.1. "Commercial Use"

means distribution or otherwise making the Covered Code available to a third party.

1.1. "Contributor"

means each entity that creates or contributes to the creation of Modifications.

1.2. "Contributor Version"

means the combination of the Original Code, prior Modifications used by a Contributor, and the Modifications made by that particular Contributor.

1.3. "Covered Code"

means the Original Code or Modifications or the combination of the Original Code and Modifications, in each case including portions thereof.

1.4. "Electronic Distribution Mechanism"

means a mechanism generally accepted in the software development community for the electronic transfer of data.

1.5. "Executable"

means Covered Code in any form other than Source Code.

1.6. "Initial Developer"

means the individual or entity identified as the Initial Developer in the Source Code notice required by Exhibit A.

1.7. "Larger Work"

means a work which combines Covered Code or portions thereof with code not governed by the terms of this License.

1.8. "License"

means this document.

1.8.1. "Licensable"

means having the right to grant, to the maximum extent possible, whether at the time of the initial grant or subsequently acquired, any and all of the rights conveyed herein.

1.9. "Modifications"

means any addition to or deletion from the substance or structure of either the Original Code or any previous Modifications. When Covered Code is released as a series of files, a Modification is:

- a. Any addition to or deletion from the contents of a file containing Original Code or previous Modifications.
- b. Any new file that contains any part of the Original Code or previous Modifications.

1.10. "Original Code"

means Source Code of computer software code which is described in the Source Code notice required by Exhibit A as Original Code, and which, at the time of its release under this License is not already Covered Code governed by this License.

1.10.1. "Patent Claims"

means any patent claim(s), now owned or hereafter acquired, including without limitation, method, process, and apparatus claims, in any patent Licensable by grantor.

1.11. "Source Code"

means the preferred form of the Covered Code for making modifications to it, including all modules it contains, plus any associated interface definition files, scripts used to control compilation and installation of an Executable, or source code differential comparisons against either the Original Code or another well known, available Covered Code of the Contributor's choice. The Source Code can be in a compressed or archival form, provided the appropriate decompression or de-archiving software is widely available for no charge.

1.12. "You" (or "Your")

means an individual or a legal entity exercising rights under, and complying with all of the terms of, this License or a future version of this License issued under Section 6.1. For legal entities, "You" includes any entity which controls, is controlled by, or is under common control with You. For purposes of this definition, "control" means (a) the power, direct or indirect, to cause the direction or management of such entity, whether by contract or otherwise, or (b) ownership of more than fifty percent (50%) of the outstanding shares or beneficial ownership of such entity.

2. Source Code License.

2.1. The Initial Developer Grant.

The Initial Developer hereby grants You a world-wide, royalty-free, non-exclusive license, subject to third party intellectual property claims:

- a. under intellectual property rights (other than patent or trademark) Licensable by Initial Developer to use, reproduce, modify, display, perform, sublicense and distribute the Original Code (or portions thereof) with or without Modifications, and/or as part of a Larger Work; and
- b. under Patents Claims infringed by the making, using or selling of Original Code, to make, have made, use, practice, sell, and offer for sale, and/or otherwise dispose of the Original Code (or portions thereof).
- c. the licenses granted in this Section 2.1 (a) and (b) are effective on the date Initial Developer first distributes Original Code under the terms of this License.
- d. Notwithstanding Section 2.1 (b) above, no patent license is granted: 1) for code that You delete from the Original Code; 2) separate from the Original Code; or 3) for infringements caused by: i) the modification of the Original Code or ii) the combination of the Original Code with other software or devices.

2.2. Contributor Grant.

Subject to third party intellectual property claims, each Contributor hereby grants You a world-wide, royalty-free, non-exclusive license

- a. under intellectual property rights (other than patent or trademark) Licensable by Contributor, to use, reproduce, modify, display, perform, sublicense and distribute the Modifications created by such Contributor (or portions thereof) either on an unmodified basis, with other Modifications, as Covered Code and/or as part of a Larger Work; and
- b. under Patent Claims infringed by the making, using, or selling of Modifications made by that Contributor either alone and/or in combination with its Contributor Version (or portions of such combination), to make, use, sell, offer for sale, have made, and/or otherwise dispose of: 1) Modifications made by that Contributor (or portions thereof); and 2) the combination of Modifications made by that Contributor with its Contributor Version (or portions of such combination).
- c. the licenses granted in Sections 2.2 (a) and 2.2 (b) are effective on the date Contributor first makes Commercial Use of the Covered Code.
- d. Notwithstanding Section 2.2 (b) above, no patent license is granted: 1) for any code that Contributor has deleted from the Contributor Version; 2) separate from the Contributor Version; 3) for infringements caused by: i) third party modifications of Contributor Version or ii) the combination of Modifications made by that Contributor with other software (except as part of the Contributor Version) or other devices; or 4) under Patent Claims infringed by Covered Code in the absence of Modifications made by that Contributor.

3. Distribution Obligations.

3.1. Application of License.

The Modifications which You create or to which You contribute are governed by the terms of this License, including without limitation Section 2.2. The Source Code version of Covered Code may be distributed only under the terms of this License or a future version of this License released under Section 6.1, and You must include a copy of this License with every copy of the Source Code You distribute. You may not offer or impose any terms on any Source Code version that alters or restricts the applicable version of this License or the recipients' rights hereunder. However, You may include an additional document offering the additional rights described in Section 3.5.

3.2. Availability of Source Code.

Any Modification which You create or to which You contribute must be made available in Source Code form under the terms of this License either on the same media as an Executable version or via an accepted Electronic Distribution Mechanism to anyone to whom you made an Executable version available; and if made available via Electronic Distribution Mechanism, must remain available for at least twelve (12) months after the date it initially became available, or at least six (6) months after a subsequent version of that particular Modification has been made available to such recipients. You are responsible for ensuring that the Source Code version remains available even if the Electronic Distribution Mechanism is maintained by a third party.

3.3. Description of Modifications.

You must cause all Covered Code to which You contribute to contain a file documenting the changes You made to create that Covered Code and the date of any change. You must include a prominent statement that the Modification is derived, directly or indirectly, from Original Code provided by the Initial Developer and including the name of the Initial Developer in (a) the Source Code, and (b) in any notice in an Executable version or related documentation in which You describe the origin or ownership of the Covered Code.

3.4. Intellectual Property Matters

(a) Third Party Claims

If Contributor has knowledge that a license under a third party's intellectual property rights is required to exercise the rights granted by such Contributor under Sections 2.1 or 2.2, Contributor must include a text file with the Source Code distribution titled "LEGAL" which describes the claim and the party making the claim in sufficient detail that a recipient will know whom to contact. If Contributor obtains such knowledge after the Modification is made available as described in Section 3.2, Contributor shall promptly modify the LEGAL file in all copies Contributor makes available thereafter and shall take other steps (such as notifying appropriate mailing lists or newsgroups) reasonably calculated to inform those who received the Covered Code that new knowledge has been obtained.

(b) Contributor APIs

If Contributor's Modifications include an application programming interface and Contributor has knowledge of patent licenses which are reasonably necessary to implement that API, Contributor must also include this information in the legal file.

(c) Representations.

Contributor represents that, except as disclosed pursuant to Section 3.4 (a) above, Contributor believes that Contributor's Modifications are Contributor's original creation(s) and/or Contributor has sufficient rights to grant the rights conveyed by this License.

3.5. Required Notices.

You must duplicate the notice in Exhibit A in each file of the Source Code. If it is not possible to put such notice in a particular Source Code file due to its structure, then You must include such notice in a location (such as a relevant directory) where a user would be likely to look for such a notice. If You created one or more Modification(s) You may add your name as a Contributor to the notice described in Exhibit A. You must also duplicate this License in any documentation for the Source Code where You describe recipients' rights or ownership rights relating to Covered Code. You may choose to offer, and to charge a fee for, warranty, support, indemnity or liability obligations to one or more recipients of Covered Code. However, You may do so only on Your own behalf, and not on behalf of the Initial Developer or any Contributor. You must make it absolutely clear than any such warranty, support, indemnity or liability obligation is offered by You alone, and You hereby agree to indemnify the Initial Developer and every Contributor for any liability incurred by the Initial Developer or such Contributor as a result of warranty, support, indemnity or liability terms You offer.

3.6. Distribution of Executable Versions.

You may distribute Covered Code in Executable form only if the requirements of Sections 3.1, 3.2, 3.3, 3.4 and 3.5 have been met for that Covered Code, and if You include a notice stating that the Source Code version of the Covered Code is available under the terms of this License, including a description of how and where You have fulfilled the obligations of Section 3.2. The notice must be conspicuously included in any notice in an Executable version, related documentation or collateral in which You describe recipients' rights relating to the Covered Code. You may distribute the Executable version of Covered Code or ownership rights under a license of Your choice, which may contain terms different from this License, provided that You are in compliance with the terms of this License and that the license for the Executable version does not attempt to limit or alter the recipient's rights in the Source Code version from the rights set forth in this License. If You distribute the Executable version under a different license You must make it absolutely clear that any terms which differ from this License are offered by You

alone, not by the Initial Developer or any Contributor. You hereby agree to indemnify the Initial Developer and every Contributor for any liability incurred by the Initial Developer or such Contributor as a result of any such terms You offer.

3.7. Larger Works.

You may create a Larger Work by combining Covered Code with other code not governed by the terms of this License and distribute the Larger Work as a single product. In such a case, You must make sure the requirements of this License are fulfilled for the Covered Code.

4. Inability to Comply Due to Statute or Regulation.

If it is impossible for You to comply with any of the terms of this License with respect to some or all of the Covered Code due to statute, judicial order, or regulation then You must: (a) comply with the terms of this License to the maximum extent possible; and (b) describe the limitations and the code they affect. Such description must be included in the **legal** file described in Section 3.4 and must be included with all distributions of the Source Code. Except to the extent prohibited by statute or regulation, such description must be sufficiently detailed for a recipient of ordinary skill to be able to understand it.

5. Application of this License.

This License applies to code to which the Initial Developer has attached the notice in Exhibit A and to related Covered Code.

6. Versions of the License.

6.1. New Versions

Netscape Communications Corporation ("Netscape") may publish revised and/or new versions of the License from time to time. Each version will be given a distinguishing version number.

6.2. Effect of New Versions

Once Covered Code has been published under a particular version of the License, You may always continue to use it under the terms of that version. You may also choose to use such Covered Code under the terms of any subsequent version of the License published by Netscape. No one other than Netscape has the right to modify the terms applicable to Covered Code created under this License.

6.3. Derivative Works

If You create or use a modified version of this License (which you may only do in order to apply it to code which is not already Covered Code governed by this License), You must (a) rename Your license so that the phrases "Mozilla",

"MOZILLAPL", "MOZPL", "Netscape", "MPL", "NPL" or any confusingly similar phrase do not appear in your license (except to note that your license differs from this License) and (b) otherwise make it clear that Your version of the license contains terms which differ from the Mozilla Public License and Netscape Public License. (Filling in the name of the Initial Developer, Original Code or Contributor in the notice described in Exhibit A shall not of themselves be deemed to be modifications of this License.)

7. Disclaimer of warranty

Covered code is provided under this license on an "as is" basis, without warranty of any kind, either expressed or implied, including, without limitation, warranties that the covered code is free of defects, merchantable, fit for a particular purpose or non-infringing. The entire risk as to the quality and performance of the covered code is with you. Should any covered code prove defective in any respect, you (not the initial developer or any other contributor) assume the cost of any necessary servicing, repair or correction. This disclaimer of warranty constitutes an essential part of this license. No use of any covered code is authorized hereunder except under this disclaimer.

8. Termination

8.1. This License and the rights granted hereunder will terminate automatically if You fail to comply with terms herein and fail to cure such breach within 30 days of becoming aware of the breach. All sublicenses to the Covered Code which are properly granted shall survive any termination of this License. Provisions which, by their nature, must remain in effect beyond the termination of this License shall survive.

8.2. If You initiate litigation by asserting a patent infringement claim (excluding declaratory judgment actions) against Initial Developer or a Contributor (the Initial Developer or Contributor against whom You file such action is referred to as "Participant") alleging that:

- a. such Participant's Contributor Version directly or indirectly infringes any patent, then any and all rights granted by such Participant to You under Sections 2.1 and/or 2.2 of this License shall, upon 60 days notice from Participant terminate prospectively, unless if within 60 days after receipt of notice You either: (i) agree in writing to pay Participant a mutually agreeable reasonable royalty for Your past and future use of Modifications made by such Participant, or (ii) withdraw Your litigation claim with respect to the Contributor Version against such Participant. If within 60 days of notice, a reasonable royalty and

payment arrangement are not mutually agreed upon in writing by the parties or the litigation claim is not withdrawn, the rights granted by Participant to You under Sections 2.1 and/or 2.2 automatically terminate at the expiration of the 60 day notice period specified above.

b. any software, hardware, or device, other than such Participant's Contributor Version, directly or indirectly infringes any patent, then any rights granted to You by such Participant under Sections 2.1(b) and 2.2(b) are revoked effective as of the date You first made, used, sold, distributed, or had made, Modifications made by that Participant.

8.3. If You assert a patent infringement claim against Participant alleging that such Participant's Contributor Version directly or indirectly infringes any patent where such claim is resolved (such as by license or settlement) prior to the initiation of patent infringement litigation, then the reasonable value of the licenses granted by such Participant under Sections 2.1 or 2.2 shall be taken into account in determining the amount or value of any payment or license.

8.4. In the event of termination under Sections 8.1 or 8.2 above, all end user license agreements (excluding distributors and resellers) which have been validly granted by You or any distributor hereunder prior to termination shall survive termination.

9. Limitation of liability

Under no circumstances and under no legal theory, whether tort (including negligence), contract, or otherwise, shall you, the initial developer, any other contributor, or any distributor of covered code, or any supplier of any of such parties, be liable to any person for any indirect, special, incidental, or consequential damages of any character including, without limitation, damages for loss of goodwill, work stoppage, computer failure or malfunction, or any and all other commercial damages or losses, even if such party shall have been informed of the possibility of such damages. This limitation of liability shall not apply to liability for death or personal injury resulting from such party's negligence to the extent applicable law prohibits such limitation. Some jurisdictions do not allow the exclusion or limitation of incidental or consequential damages, so this exclusion and limitation may not apply to you.

10. U.S. government end users

The Covered Code is a "commercial item," as that term is defined in 48 C.F.R. 2.101 (Oct. 1995), consisting of "commercial computer software" and "commercial computer software documentation," as such terms are used in 48 C.F.R. 12.212 (Sept. 1995). Consistent with 48 C.F.R. 12.212 and 48 C.F.R. 227.7202-1 through 227.7202-4 (June 1995), all U.S. Government End Users acquire Covered Code with only those rights set forth herein.

11. Miscellaneous

This License represents the complete agreement concerning subject matter hereof. If any provision of this License is held to be unenforceable, such provision shall be reformed only to the extent necessary to make it enforceable. This License shall be governed by California law provisions (except to the extent applicable law, if any, provides otherwise), excluding its conflict-of-law provisions. With respect to disputes in which at least one party is a citizen of, or an entity chartered or registered to do business in the United States of America, any litigation relating to this License shall be subject to the jurisdiction of the Federal Courts of the Northern District of California, with venue lying in Santa Clara County, California, with the losing party responsible for costs, including without limitation, court costs and reasonable attorneys' fees and expenses. The application of the United Nations Convention on Contracts for the International Sale of Goods is expressly excluded. Any law or regulation which provides that the language of a contract shall be construed against the drafter shall not apply to this License.

12. Responsibility for claims

As between Initial Developer and the Contributors, each party is responsible for claims and damages arising, directly or indirectly, out of its utilization of rights under this License and You agree to work with Initial Developer and Contributors to distribute such responsibility on an equitable basis. Nothing herein is intended or shall be deemed to constitute any admission of liability.

13. Multiple-licensed code

Initial Developer may designate portions of the Covered Code as "Multiple-Licensed". "Multiple-Licensed" means that the Initial Developer permits you to utilize portions of the Covered Code under Your choice of the MPL or the alternative licenses, if any, specified by the Initial Developer in the file described in Exhibit A.

Exhibit A - Mozilla Public License.

"The contents of this file are subject to the Mozilla Public License

Version 1.1 (the "License"); you may not use this file except in

compliance with the License. You may obtain a copy of the License at

<http://www.mozilla.org/MPL/>

Software distributed under the License is distributed on an "AS IS" basis, WITHOUT WARRANTY OF ANY KIND, either express or implied. See the License for the specific language governing rights and limitations under the License.

The Original Code is _____.

The Initial Developer of the Original Code is _____.

Portions created by _____ are Copyright (C) _____
_____. All Rights Reserved.

Contributor(s): _____.

Alternatively, the contents of this file may be used under the terms of the _____ license (the "[_____] License"), in which case the provisions of [_____] License are applicable instead of those above. If you wish to allow use of your version of this file only under the terms of the [_____] License and not to allow others to use your version of this file under the MPL, indicate your decision by deleting the provisions above and replace them with the notice and other provisions required by the [_____] License. If you do not delete the provisions above, a recipient may use your version of this file under either the MPL or the [_____] License."

NOTE: The text of this Exhibit A may differ slightly from the text of the notices in the Source Code files of the Original Code. You should use the text of this Exhibit A rather than the text found in the Original Code Source Code for Your Modifications.

End-User License Agreement for “ZyWALL USG 20W”

WARNING: ZyXEL Communications Corp. IS WILLING TO LICENSE THE SOFTWARE TO YOU ONLY UPON THE CONDITION THAT YOU ACCEPT ALL OF THE TERMS CONTAINED IN THIS LICENSE AGREEMENT. PLEASE READ THE TERMS CAREFULLY BEFORE COMPLETING THE INSTALLATION PROCESS AS INSTALLING THE SOFTWARE WILL INDICATE YOUR ASSENT TO THEM. IF YOU DO NOT AGREE TO THESE TERMS, THEN ZyXEL IS UNWILLING TO LICENSE THE SOFTWARE TO YOU, IN WHICH EVENT YOU SHOULD RETURN THE UNINSTALLED SOFTWARE AND PACKAGING TO THE PLACE FROM WHICH IT WAS ACQUIRED OR ZyXEL, AND YOUR MONEY WILL BE REFUNDED. HOWEVER CERTAIN COMPONENTS OF THE SOFTWARE, AND THIRD PARTY OPEN SOURCE PROGRAMS INCLUDED WITH THE SOFTWARE, HAVE BEEN OR MAY BE MADE AVAILABLE BY ZyXEL LISTED IN THE BELOW NOTICE (COLLECTIVELY THE “OPEN-SOURCED COMPONENTS”). FOR THESE OPEN-SOURCED COMPONENTS YOU SHOULD COMPLY WITH THE TERMS OF THIS LICENSE AND ANY APPLICABLE LICENSING TERMS GOVERNING USE OF THE OPEN-SOURCED COMPONENTS, WHICH HAVE BEEN PROVIDED ON THE LICENSE NOTICE AS BELOW FOR THE SOFTWARE.

1. Grant of License for Personal Use

ZyXEL Communications Corp. ("ZyXEL") grants you a non-exclusive, non-sublicense, non-transferable license to use the program with which this license is distributed (the "Software"), including any documentation files accompanying the Software ("Documentation"), for internal business use only, for up to the number of users specified in sales order and invoice. You have the right to make one backup copy of the Software and Documentation solely for archival, back-up or disaster recovery purposes. You shall not exceed the scope of the license granted hereunder. Any rights not expressly granted by ZyXEL to you are reserved by ZyXEL, and all implied licenses are disclaimed.

2. Ownership

You have no ownership rights in the Software. Rather, you have a license to use the Software as long as this License Agreement remains in full force and effect. Ownership of the Software, Documentation and all intellectual property rights therein shall remain at all times with ZyXEL. Any other use of the Software by any other entity is strictly forbidden and is a violation of this License Agreement.

3. Copyright

The Software and Documentation contain material that is protected by International Copyright Law and trade secret law, and by international treaty provisions. All rights not granted to you herein are expressly reserved by ZyXEL. You may not remove any proprietary notice of ZyXEL or any of its licensors from any copy of the Software or Documentation.

4. Restrictions

You may not publish, display, disclose, sell, rent, lease, modify, store, loan, distribute, or create derivative works of the Software, or any part thereof. You may not assign, sublicense, convey or otherwise transfer, pledge as security or otherwise encumber the rights and licenses granted hereunder with respect to the Software. Certain components of the Software, and third party open source programs included with the Software, have been or may be made available by ZyXEL listed in the below Notice (collectively the "Open-Sourced Components") You may modify or replace only these Open-Sourced Components; provided that you comply with the terms of this License and any applicable licensing terms governing use of the Open-Sourced Components, which have been provided on the License Notice as below for the Software. ZyXEL is not obligated to provide any maintenance, technical or other support for the resultant modified Software. You may not copy, reverse engineer, decompile, reverse compile, translate, adapt, or disassemble the Software, or any part thereof, nor shall you attempt to create the source code from the object code for the Software. Except as and only to the extent expressly permitted in this License, by applicable licensing terms governing use of the Open-Sourced Components, or by applicable law, you may not market, co-brand, private label or otherwise permit third parties to link to the Software, or any part thereof. You may not use the Software, or any part thereof, in the operation of a service bureau or for the benefit of any other person or entity. You may not cause, assist or permit any third party to do any of the foregoing. Portions of the Software utilize or include third party software and other copyright material. Acknowledgements, licensing terms and disclaimers for such material are contained in the License Notice as below for the Software, and your use of such material is governed by their respective terms. ZyXEL has provided, as part of the Software package, access to certain third party software as a convenience. To the extent that the Software contains third party software, ZyXEL has no express or implied obligation to provide any technical or other support for such software. Please contact the appropriate software vendor or manufacturer directly for technical support and customer service related to its software and products.

5. Confidentiality

You acknowledge that the Software contains proprietary trade secrets of ZyXEL and you hereby agree to maintain the confidentiality of the Software using at least as great a degree of care as you use to maintain the confidentiality of your own most confidential information. You agree to reasonably communicate the terms and conditions of this License Agreement to those persons employed by you who come into contact with the Software, and to use reasonable best efforts to ensure their compliance with such terms and conditions, including, without limitation, not knowingly permitting such persons to use any portion of the Software for the purpose of deriving the source code of the Software.

6. No Warranty

THE SOFTWARE IS PROVIDED "AS IS." TO THE MAXIMUM EXTENT PERMITTED BY LAW, ZyxEL DISCLAIMS ALL WARRANTIES OF ANY KIND, EITHER EXPRESSED OR IMPLIED, INCLUDING, WITHOUT LIMITATION, IMPLIED WARRANTIES OF MERCHANTABILITY AND FITNESS FOR A PARTICULAR PURPOSE. ZyxEL DOES NOT WARRANT THAT THE FUNCTIONS CONTAINED IN THE SOFTWARE WILL MEET ANY REQUIREMENTS OR NEEDS YOU MAY HAVE, OR THAT THE SOFTWARE WILL OPERATE ERROR FREE, OR IN AN UNINTERRUPTED FASHION, OR THAT ANY DEFECTS OR ERRORS IN THE SOFTWARE WILL BE CORRECTED, OR THAT THE SOFTWARE IS COMPATIBLE WITH ANY PARTICULAR PLATFORM. SOME JURISDICTIONS DO NOT ALLOW THE WAIVER OR EXCLUSION OF IMPLIED WARRANTIES SO THEY MAY NOT APPLY TO YOU. IF THIS EXCLUSION IS HELD TO BE UNENFORCEABLE BY A COURT OF COMPETENT JURISDICTION, THEN ALL EXPRESS AND IMPLIED WARRANTIES SHALL BE LIMITED IN DURATION TO A PERIOD OF THIRTY (30) DAYS FROM THE DATE OF PURCHASE OF THE SOFTWARE, AND NO WARRANTIES SHALL APPLY AFTER THAT PERIOD.

7. Limitation of Liability

IN NO EVENT WILL ZyxEL BE LIABLE TO YOU OR ANY THIRD PARTY FOR ANY INCIDENTAL OR CONSEQUENTIAL DAMAGES (INCLUDING, WITHOUT LIMITATION, INDIRECT, SPECIAL, PUNITIVE, OR EXEMPLARY DAMAGES FOR LOSS OF BUSINESS, LOSS OF PROFITS, BUSINESS INTERRUPTION, OR LOSS OF BUSINESS INFORMATION) ARISING OUT OF THE USE OF OR INABILITY TO USE THE PROGRAM, OR FOR ANY CLAIM BY ANY OTHER PARTY, EVEN IF ZyxEL HAS BEEN ADVISED OF THE POSSIBILITY OF SUCH DAMAGES. ZyxEL'S AGGREGATE LIABILITY WITH RESPECT TO ITS OBLIGATIONS UNDER THIS AGREEMENT OR OTHERWISE WITH RESPECT TO THE SOFTWARE AND DOCUMENTATION OR OTHERWISE SHALL BE EQUAL TO THE PURCHASE PRICE, BUT SHALL IN NO EVENT EXCEED THE PRODUCT'S PRICE. BECAUSE SOME STATES/COUNTRIES DO NOT ALLOW THE EXCLUSION OR LIMITATION OF LIABILITY FOR CONSEQUENTIAL OR INCIDENTAL DAMAGES, THE ABOVE LIMITATION MAY NOT APPLY TO YOU.

8. Export Restrictions

THIS LICENSE AGREEMENT IS EXPRESSLY MADE SUBJECT TO ANY APPLICABLE LAWS, REGULATIONS, ORDERS, OR OTHER RESTRICTIONS ON THE EXPORT OF THE SOFTWARE OR INFORMATION ABOUT SUCH SOFTWARE WHICH MAY BE IMPOSED FROM TIME TO TIME. YOU SHALL NOT EXPORT THE SOFTWARE, DOCUMENTATION OR INFORMATION ABOUT THE SOFTWARE AND DOCUMENTATION WITHOUT COMPLYING WITH SUCH LAWS, REGULATIONS, ORDERS, OR OTHER RESTRICTIONS. YOU AGREE TO INDEMNIFY ZyxEL AGAINST ALL CLAIMS, LOSSES, DAMAGES, LIABILITIES, COSTS AND EXPENSES, INCLUDING REASONABLE ATTORNEYS' FEES, TO THE EXTENT SUCH CLAIMS ARISE OUT OF ANY BREACH OF THIS SECTION 8.

9. Audit Rights

ZyXEL SHALL HAVE THE RIGHT, AT ITS OWN EXPENSE, UPON REASONABLE PRIOR NOTICE, TO PERIODICALLY INSPECT AND AUDIT YOUR RECORDS TO ENSURE YOUR COMPLIANCE WITH THE TERMS AND CONDITIONS OF THIS LICENSE AGREEMENT.

10. Termination

This License Agreement is effective until it is terminated. You may terminate this License Agreement at any time by destroying or returning to ZyXEL all copies of the Software and Documentation in your possession or under your control. ZyXEL may terminate this License Agreement for any reason, including, but not limited to, if ZyXEL finds that you have violated any of the terms of this License Agreement. Upon notification of termination, you agree to destroy or return to ZyXEL all copies of the Software and Documentation and to certify in writing that all known copies, including backup copies, have been destroyed. All provisions relating to confidentiality, proprietary rights, and non-disclosure shall survive the termination of this Software License Agreement.

11. General

This License Agreement shall be construed, interpreted and governed by the laws of Republic of China without regard to conflicts of laws provisions thereof. The exclusive forum for any disputes arising out of or relating to this License Agreement shall be an appropriate court or Commercial Arbitration Association sitting in ROC, Taiwan. This License Agreement shall constitute the entire Agreement between the parties hereto. This License Agreement, the rights granted hereunder, the Software and Documentation shall not be assigned by you without the prior written consent of ZyXEL. Any waiver or modification of this License Agreement shall only be effective if it is in writing and signed by both parties hereto. If any part of this License Agreement is found invalid or unenforceable by a court of competent jurisdiction, the remainder of this License Agreement shall be interpreted so as to reasonably effect the intention of the parties.

NOTE: Some components of this product incorporate source code covered under the open source code licenses. Further, for at least three (3) years from the date of distribution of the applicable product or software, we will give to anyone who contacts us at the ZyXEL Technical Support (support@zyxel.com.tw), for a charge of no more than our cost of physically performing source code distribution, a complete machine-readable copy of the complete corresponding source code for the version of the Programs that we distributed to you if we are in possession of such.

Notice

Information herein is subject to change without notice. Companies, names, and data used in examples herein are fictitious unless otherwise noted. No part may

be reproduced or transmitted in any form or by any means, electronic or mechanical, for any purpose, except the express written permission of ZyXEL Communications Corporation.

This Product includes ntp software under the NTP License

NTP License

Copyright (c) David L. Mills 1992-2004

Permission to use, copy, modify, and distribute this software and its documentation for any purpose and without fee is hereby granted, provided that the above copyright notice appears in all copies and that both the copyright notice and this permission notice appear in supporting documentation, and that the name University of Delaware not be used in advertising or publicity pertaining to distribution of the software without specific, written prior permission. The University of Delaware makes no representations about the suitability this software for any purpose. It is provided "as is" without express or implied warranty.

This Product includes expat software under the Expat License

Expat License

Copyright (c) 1998, 1999, 2000 Thai Open Source Software Center Ltd

Permission is hereby granted, free of charge, to any person obtaining a copy of this software and associated documentation files (the "Software"), to deal in the Software without restriction, including

without limitation the rights to use, copy, modify, merge, publish, distribute, sublicense, and/or sell copies of the Software, and to permit persons to whom the Software is furnished to do so, subject to

the following conditions:

The above copyright notice and this permission notice shall be included in all copies or substantial portions of the Software.

THE SOFTWARE IS PROVIDED "AS IS", WITHOUT WARRANTY OF ANY KIND, EXPRESS OR IMPLIED, INCLUDING BUT NOT LIMITED TO THE WARRANTIES OF MERCHANTABILITY, FITNESS FOR A PARTICULAR PURPOSE AND NONINFRINGEMENT.

IN NO EVENT SHALL THE AUTHORS OR COPYRIGHT HOLDERS BE LIABLE FOR ANY CLAIM, DAMAGES OR OTHER LIABILITY, WHETHER IN AN ACTION OF CONTRACT, TORT OR OTHERWISE, ARISING FROM, OUT OF OR IN CONNECTION WITH THE SOFTWARE OR THE USE OR OTHER DEALINGS IN THE SOFTWARE.

an X11-style license

This is a Free Software License

This license is compatible with [The GNU General Public License, Version 1](#)

This license is compatible with [The GNU General Public License, Version 2](#)

This is just like a [Simple Permissive](#) license, but it requires that a copyright notice be maintained.

Permission is hereby granted, free of charge, to any person obtaining a copy of this software and associated documentation files (the "Software"), to deal in the Software without restriction, including without limitation the rights to use, copy, modify, merge, publish, distribute, sublicense, and/or sell copies of the Software, and to permit persons to whom the Software is furnished to do so, subject to the following conditions:

The above copyright notice and this permission notice shall be included in all copies or substantial portions of the Software.

This Product includes ppp-2.4.2 software under the PPP License

OpenSSL

LICENSE ISSUES

=====

The OpenSSL toolkit stays under a dual license, i.e. both the conditions of the OpenSSL License and the original SSLeay license apply to the toolkit. See below for the actual license texts. Actually both licenses are BSD-style Open Source licenses. In case of any license issues related to OpenSSL please contact openssl-core@openssl.org.

OpenSSL License

/*

=====

* Copyright (c) 1998-2008 The OpenSSL Project. All rights reserved.

*

* Redistribution and use in source and binary forms, with or without

* modification, are permitted provided that the following conditions

- * are met:
- *
 - * 1. Redistributions of source code must retain the above copyright notice, this list of conditions and the following disclaimer.
 - *
 - * 2. Redistributions in binary form must reproduce the above copyright notice, this list of conditions and the following disclaimer in the documentation and/or other materials provided with the distribution.
 - *
 - * 3. All advertising materials mentioning features or use of this software must display the following acknowledgment:
 - * "This product includes software developed by the OpenSSL Project for use in the OpenSSL Toolkit. (<http://www.openssl.org/>)"
 - *
 - * 4. The names "OpenSSL Toolkit" and "OpenSSL Project" must not be used to endorse or promote products derived from this software without prior written permission. For written permission, please contact openssl-core@openssl.org.
 - *
 - * 5. Products derived from this software may not be called "OpenSSL" nor may "OpenSSL" appear in their names without prior written permission of the OpenSSL Project.
 - *
 - * 6. Redistributions of any form whatsoever must retain the following

* acknowledgment:

* "This product includes software developed by the OpenSSL Project

* for use in the OpenSSL Toolkit (<http://www.openssl.org/>)"

*

* THIS SOFTWARE IS PROVIDED BY THE OpenSSL PROJECT ``AS IS" AND ANY

* EXPRESSED OR IMPLIED WARRANTIES, INCLUDING, BUT NOT LIMITED TO, THE

* IMPLIED WARRANTIES OF MERCHANTABILITY AND FITNESS FOR A

PARTICULAR

* PURPOSE ARE DISCLAIMED. IN NO EVENT SHALL THE OpenSSL PROJECT OR

* ITS CONTRIBUTORS BE LIABLE FOR ANY DIRECT, INDIRECT, INCIDENTAL,

* SPECIAL, EXEMPLARY, OR CONSEQUENTIAL DAMAGES (INCLUDING, BUT

* NOT LIMITED TO, PROCUREMENT OF SUBSTITUTE GOODS OR SERVICES;

* LOSS OF USE, DATA, OR PROFITS; OR BUSINESS INTERRUPTION)

* HOWEVER CAUSED AND ON ANY THEORY OF LIABILITY, WHETHER IN

CONTRACT,

* STRICT LIABILITY, OR TORT (INCLUDING NEGLIGENCE OR OTHERWISE)

* ARISING IN ANY WAY OUT OF THE USE OF THIS SOFTWARE, EVEN IF ADVISED

* OF THE POSSIBILITY OF SUCH DAMAGE.

*

=====

*

* This product includes cryptographic software written by Eric Young

* (eay@cryptsoft.com). This product includes software written by Tim

* Hudson (tjh@cryptsoft.com).

*

*/

Original SSLeay License

```
/* Copyright (C) 1995-1998 Eric Young (eay@cryptsoft.com)
 * All rights reserved.
 *
 * This package is an SSL implementation written
 * by Eric Young (eay@cryptsoft.com).
 * The implementation was written so as to conform with Netscapes SSL.
 *
 * This library is free for commercial and non-commercial use as long as
 * the following conditions are aheared to. The following conditions
 * apply to all code found in this distribution, be it the RC4, RSA,
 * lhash, DES, etc., code; not just the SSL code. The SSL documentation
 * included with this distribution is covered by the same copyright terms
 * except that the holder is Tim Hudson (tjh@cryptsoft.com).
 *
 * Copyright remains Eric Young's, and as such any Copyright notices in
 * the code are not to be removed.
 * If this package is used in a product, Eric Young should be given attribution
 * as the author of the parts of the library used.
 * This can be in the form of a textual message at program startup or
 * in documentation (online or textual) provided with the package.
 *
 * Redistribution and use in source and binary forms, with or without
 * modification, are permitted provided that the following conditions
```

- * are met:
- * 1. Redistributions of source code must retain the copyright notice, this list of conditions and the following disclaimer.
- * 2. Redistributions in binary form must reproduce the above copyright notice, this list of conditions and the following disclaimer in the documentation and/or other materials provided with the distribution.
- * 3. All advertising materials mentioning features or use of this software must display the following acknowledgement:
 - * "This product includes cryptographic software written by Eric Young (eay@cryptsoft.com)"
 - * The word 'cryptographic' can be left out if the routines from the library being used are not cryptographic related :-).
- * 4. If you include any Windows specific code (or a derivative thereof) from the apps directory (application code) you must include an acknowledgement:
 - * "This product includes software written by Tim Hudson (tjh@cryptsoft.com)"
 - *
* THIS SOFTWARE IS PROVIDED BY ERIC YOUNG ``AS IS'' AND
* ANY EXPRESS OR IMPLIED WARRANTIES, INCLUDING, BUT NOT LIMITED TO, THE
* IMPLIED WARRANTIES OF MERCHANTABILITY AND FITNESS FOR A PARTICULAR PURPOSE
* ARE DISCLAIMED. IN NO EVENT SHALL THE AUTHOR OR CONTRIBUTORS BE LIABLE
* FOR ANY DIRECT, INDIRECT, INCIDENTAL, SPECIAL, EXEMPLARY, OR CONSEQUENTIAL
* DAMAGES (INCLUDING, BUT NOT LIMITED TO, PROCUREMENT OF SUBSTITUTE GOODS

* OR SERVICES; LOSS OF USE, DATA, OR PROFITS; OR BUSINESS INTERRUPTION)

* HOWEVER CAUSED AND ON ANY THEORY OF LIABILITY, WHETHER IN CONTRACT, STRICT

* LIABILITY, OR TORT (INCLUDING NEGLIGENCE OR OTHERWISE) ARISING IN ANY WAY

* OUT OF THE USE OF THIS SOFTWARE, EVEN IF ADVISED OF THE POSSIBILITY OF

* SUCH DAMAGE.

*

* The licence and distribution terms for any publically available version or

* derivative of this code cannot be changed. i.e. this code cannot simply be

* copied and put under another distribution licence

*

This Product includes libevent and xinetd software under the a 3-clause BSD License

a 3-clause BSD-style license

This is a Free Software License

This license is compatible with [The GNU General Public License, Version 1](#)

This license is compatible with [The GNU General Public License, Version 2](#)

This is the BSD license without the obnoxious advertising clause. It's also known as the "modified BSD license." Note that the University of California now prefers this license to the [BSD license with advertising clause](#), and now [allows BSD itself to be used under the three-clause license](#).

Redistribution and use in source and binary forms, with or without modification, are permitted provided that the following conditions are met:

- Redistributions of source code must retain the above copyright notice, this list of conditions and the following disclaimer.

- Redistributions in binary form must reproduce the above copyright notice, this list of conditions and the following disclaimer in the documentation and/or other materials provided with the distribution.
- Neither the name of [original copyright holder] nor the names of its contributors may be used to endorse or promote products derived from this software without specific prior written permission.

THIS SOFTWARE IS PROVIDED BY THE COPYRIGHT HOLDERS AND CONTRIBUTORS "AS IS" AND ANY EXPRESS OR IMPLIED WARRANTIES, INCLUDING, BUT NOT LIMITED TO, THE IMPLIED WARRANTIES OF MERCHANTABILITY AND FITNESS FOR A PARTICULAR PURPOSE ARE DISCLAIMED. IN NO EVENT SHALL THE COPYRIGHT OWNER OR CONTRIBUTORS BE LIABLE FOR ANY DIRECT, INDIRECT, INCIDENTAL, SPECIAL, EXEMPLARY, OR CONSEQUENTIAL DAMAGES (INCLUDING, BUT NOT LIMITED TO, PROCUREMENT OF SUBSTITUTE GOODS OR SERVICES; LOSS OF USE, DATA, OR PROFITS; OR BUSINESS INTERRUPTION) HOWEVER CAUSED AND ON ANY THEORY OF LIABILITY, WHETHER IN CONTRACT, STRICT LIABILITY, OR TORT (INCLUDING NEGLIGENCE OR OTHERWISE) ARISING IN ANY WAY OUT OF THE USE OF THIS SOFTWARE, EVEN IF ADVISED OF THE POSSIBILITY OF SUCH DAMAGE.

This Product includes bind and dhcp software under the ISC License

ISC license

Copyright (c) 4-digit year, Company or Person's Name

Permission to use, copy, modify, and distribute this software for any purpose with or without fee is hereby granted, provided that the above copyright notice and this permission notice appear in all copies.

THE SOFTWARE IS PROVIDED "AS IS" AND ISC DISCLAIMS ALL WARRANTIES WITH REGARD TO THIS SOFTWARE INCLUDING ALL IMPLIED WARRANTIES OF MERCHANTABILITY AND FITNESS. IN NO EVENT SHALL ISC BE LIABLE FOR ANY SPECIAL, DIRECT, INDIRECT, OR CONSEQUENTIAL DAMAGES OR ANY DAMAGES WHATSOEVER RESULTING FROM LOSS OF USE, DATA OR PROFITS, WHETHER IN AN ACTION OF CONTRACT, NEGLIGENCE OR OTHER TORTIOUS ACTION, ARISING OUT OF OR IN CONNECTION WITH THE USE OR PERFORMANCE OF THIS SOFTWARE.

This Product includes httpd software developed by the Apache Software Foundation under Apache License.

Apache License

Version 2.0, January 2004

<http://www.apache.org/licenses/>

TERMS AND CONDITIONS FOR USE, REPRODUCTION, AND DISTRIBUTION

1. Definitions.

"License" shall mean the terms and conditions for use, reproduction, and distribution as defined by Sections 1 through 9 of this document.

"Licensor" shall mean the copyright owner or entity authorized by the copyright owner that is granting the License.

"Legal Entity" shall mean the union of the acting entity and all other entities that control, are controlled by, or are under common control with that entity. For the purposes of this definition, "control" means (i) the power, direct or indirect, to cause the direction or management of such entity, whether by contract or otherwise, or (ii) ownership of fifty percent (50%) or more of the outstanding shares, or (iii) beneficial ownership of such entity.

"You" (or "Your") shall mean an individual or Legal Entity exercising permissions granted by this License.

"Source" form shall mean the preferred form for making modifications, including but not limited to software source code, documentation source, and configuration files.

"Object" form shall mean any form resulting from mechanical transformation or translation of a Source form, including but not limited to compiled object code, generated documentation, and conversions to other media types.

"Work" shall mean the work of authorship, whether in Source or Object form, made available under the License, as indicated by a copyright notice that is included in or attached to the work (an example is provided in the Appendix below).

"Derivative Works" shall mean any work, whether in Source or Object form, that is based on (or derived from) the Work and for which the editorial revisions, annotations, elaborations, or other modifications represent, as a whole, an original work of authorship. For the purposes of this License, Derivative Works shall not include works that remain separable from, or merely link (or bind by name) to the interfaces of, the Work and Derivative Works thereof.

"Contribution" shall mean any work of authorship, including the original version of the Work and any modifications or additions to that Work or Derivative Works thereof, that is intentionally submitted to Licensor for inclusion in the Work by the copyright owner or by an individual or Legal Entity authorized to submit on behalf of the copyright owner. For the purposes of this definition, "submitted" means any form of electronic, verbal, or written communication sent to the Licensor or its representatives, including but not limited to communication on electronic mailing lists, source code control systems, and issue tracking systems that are managed

by, or on behalf of, the Licensor for the purpose of discussing and improving the Work, but excluding communication that is conspicuously marked or otherwise designated in writing by the copyright owner as "Not a Contribution."

"Contributor" shall mean Licensor and any individual or Legal Entity on behalf of whom a Contribution has been received by Licensor and subsequently incorporated within the Work.

2. Grant of Copyright License. Subject to the terms and conditions of this License, each Contributor hereby grants to You a perpetual, worldwide, non-exclusive, no-charge, royalty-free, irrevocable copyright license to reproduce, prepare Derivative Works of, publicly display, publicly perform, sublicense, and distribute the Work and such Derivative Works in Source or Object form.

3. Grant of Patent License. Subject to the terms and conditions of this License, each Contributor hereby grants to You a perpetual, worldwide, non-exclusive, no-charge, royalty-free, irrevocable (except as stated in this section) patent license to make, have made, use, offer to sell, sell, import, and otherwise transfer the Work, where such license applies only to those patent claims licensable by such Contributor that are necessarily infringed by their Contribution(s) alone or by combination of their Contribution(s) with the Work to which such Contribution(s) was submitted. If You institute patent litigation against any entity (including a cross-claim or counterclaim in a lawsuit) alleging that the Work or a Contribution incorporated within the Work constitutes direct or contributory patent infringement, then any patent licenses granted to You under this License for that Work shall terminate as of the date such litigation is filed.

4. Redistribution. You may reproduce and distribute copies of the Work or Derivative Works hereof in any medium, with or without modifications, and in Source or Object form, provided that You meet the following conditions:

(a) You must give any other recipients of the Work or Derivative Works a copy of this License; and

(b) You must cause any modified files to carry prominent notices stating that You changed the files; and

(c) You must retain, in the Source form of any Derivative Works that You distribute, all copyright, patent, trademark, and attribution notices from the Source form of the Work, excluding those notices that do not pertain to any part of the Derivative Works; and

(d) If the Work includes a "NOTICE" text file as part of its distribution, then any Derivative Works that You distribute must include a readable copy of the attribution notices contained within such NOTICE file, excluding those notices that do not pertain to any part of the Derivative Works, in at least one of the following places: within a NOTICE text file distributed as part of the Derivative Works;

within the Source form or documentation, if provided along with the Derivative Works; or, within a display generated by the Derivative Works, if and wherever such third-party notices normally appear. The contents of the NOTICE file are for informational purposes only and do not modify the License. You may add Your own attribution notices within Derivative Works that You distribute, alongside or as an addendum to the NOTICE text from the Work, provided that such additional attribution notices cannot be construed as modifying the License. You may add Your own copyright statement to Your modifications and may provide additional or different license terms and conditions for use, reproduction, or distribution of Your modifications, or for any such Derivative Works as a whole, provided Your use, reproduction, and distribution of the Work otherwise complies with the conditions stated in this License.

5. Submission of Contributions. Unless You explicitly state otherwise, any Contribution intentionally submitted for inclusion in the Work by You to the Licensor shall be under the terms and conditions of this License, without any additional terms or conditions. Notwithstanding the above, nothing herein shall supersede or modify the terms of any separate license agreement you may have executed with Licensor regarding such Contributions.

6. Trademarks. This License does not grant permission to use the trade names, trademarks, service marks, or product names of the Licensor, except as required for reasonable and customary use in describing the origin of the Work and reproducing the content of the NOTICE file.

7. Disclaimer of Warranty. Unless required by applicable law or agreed to in writing, Licensor provides the Work (and each Contributor provides its Contributions) on an "AS IS" BASIS, WITHOUT WARRANTIES OR CONDITIONS OF ANY KIND, either express or implied, including, without limitation, any warranties or conditions of TITLE, NON-INFRINGEMENT, MERCHANTABILITY, or FITNESS FOR A PARTICULAR PURPOSE. You are solely responsible for determining the appropriateness of using or redistributing the Work and assume any risks associated with Your exercise of permissions under this License.

8. Limitation of Liability. In no event and under no legal theory, whether in tort (including negligence), contract, or otherwise, unless required by applicable law (such as deliberate and grossly negligent acts) or agreed to in writing, shall any Contributor be liable to You for damages, including any direct, indirect, special, incidental, or consequential damages of any character arising as a result of this License or out of the use or inability to use the Work (including but not limited to damages for loss of goodwill, work stoppage, computer failure or malfunction, or any and all other commercial damages or losses), even if such Contributor has been advised of the possibility of such damages.

9. Accepting Warranty or Additional Liability. While redistributing the Work or Derivative Works thereof, You may choose to offer, and charge a fee for, acceptance of support, warranty, indemnity, or other liability obligations and/or

rights consistent with this License. However, in accepting such obligations, You may act only on Your own behalf and on Your sole responsibility, not on behalf of any other Contributor, and only if You agree to indemnify, defend, and hold each Contributor harmless for any liability incurred by, or claims asserted against, such Contributor by reason of your accepting any such warranty or additional liability.

END OF TERMS AND CONDITIONS

Version 1.1

Copyright (c) 1999-2003 The Apache Software Foundation. All rights reserved.

Redistribution and use in source and binary forms, with or without modification, are permitted provided that the following conditions are met:

Redistributions of source code must retain the above copyright notice, this list of conditions and the following disclaimer.

Redistributions in binary form must reproduce the above copyright notice, this list of conditions and the following disclaimer in the documentation and/or other materials provided with the distribution.

The end-user documentation included with the redistribution, if any, must include the following acknowledgment: "This product includes software developed by the Apache Software Foundation (<http://www.apache.org/>).¹ Alternately, this acknowledgment may appear in the software itself, if and wherever such third-party acknowledgments normally appear.

The names "Apache" and "Apache Software Foundation" must not be used to endorse or promote products derived from this software without prior written permission. For written permission, please contact apache@apache.org.

Products derived from this software may not be called "Apache", nor may "Apache" appear in their name, without prior written permission of the Apache Software Foundation.

THIS SOFTWARE IS PROVIDED "AS IS" AND ANY EXPRESSED OR IMPLIED WARRANTIES, INCLUDING, BUT NOT LIMITED TO, THE IMPLIED WARRANTIES OF MERCHANTABILITY AND FITNESS FOR A PARTICULAR PURPOSE ARE DISCLAIMED. IN NO EVENT SHALL THE APACHE SOFTWARE FOUNDATION OR ITS CONTRIBUTORS BE LIABLE FOR ANY DIRECT, INDIRECT, INCIDENTAL, SPECIAL, EXEMPLARY, OR CONSEQUENTIAL DAMAGES (INCLUDING, BUT NOT LIMITED TO, PROCUREMENT OF SUBSTITUTE GOODS OR SERVICES; LOSS OF USE, DATA, OR PROFITS; OR BUSINESS INTERRUPTION) HOWEVER CAUSED AND ON ANY THEORY OF LIABILITY, WHETHER IN CONTRACT, STRICT LIABILITY, OR TORT (INCLUDING NEGLIGENCE OR OTHERWISE) ARISING IN ANY WAY OUT OF THE USE OF THIS SOFTWARE, EVEN IF ADVISED OF THE POSSIBILITY OF SUCH DAMAGE.

This software consists of voluntary contributions made by many individuals on behalf of the Apache Software Foundation. For more information on the Apache Software Foundation, please see <<http://www.apache.org/>>.

Portions of this software are based upon public domain software originally written at the National Center for Supercomputing Applications, University of Illinois, Urbana-Champaign.

GNU LESSER GENERAL PUBLIC LICENSE

Version 2.1, February 1999

Copyright (C) 1991, 1999 Free Software Foundation, Inc.

59 Temple Place, Suite 330, Boston, MA 02111-1307 USA

Everyone is permitted to copy and distribute verbatim copies of this license document, but changing it is not allowed. [This is the first released version of the Lesser GPL. It also counts

as the successor of the GNU Library Public License, version 2, hence the version number 2.1.

Preamble

The licenses for most software are designed to take away your freedom to share and change it. By contrast, the GNU General Public Licenses are intended to guarantee your freedom to share and change free software--to make sure the software is free for all its users.

This license, the Lesser General Public License, applies to some specially designated software packages--typically libraries--of the Free Software Foundation and other authors who decide to use it. You can use it too, but we suggest you first think carefully about whether this license or the ordinary General Public License is the better strategy to use in any particular case, based on the explanations below.

When we speak of free software, we are referring to freedom of use, not price. Our General Public Licenses are designed to make sure that you have the freedom to distribute copies of free software (and charge for this service if you wish); that you receive source code or can get

it if you want it; that you can change the software and use pieces of it in new free programs; and that you are informed that you can do these things.

To protect your rights, we need to make restrictions that forbid distributors to deny you these rights or to ask you to surrender these rights. These restrictions

translate to certain responsibilities for you if you distribute copies of the library or if you modify it.

For example, if you distribute copies of the library, whether gratis or for a fee, you must give the recipients all the rights that we gave you. You must make sure that they, too, receive or can get the source code. If you link other code with the library, you must provide complete object files to the recipients, so that they can relink them with the library after making changes to the library and recompiling it. And you must show them these terms so they know their rights.

We protect your rights with a two-step method: (1) we copyright the library, and (2) we offer you this license, which gives you legal permission to copy, distribute and/or modify the library.

To protect each distributor, we want to make it very clear that there is no warranty for the free library. Also, if the library is modified by someone else and passed on, the recipients should know that what they have is not the original version, so that the original author's reputation will not be affected by problems that might be introduced by others.

Finally, software patents pose a constant threat to the existence of any free program. We wish to make sure that a company cannot effectively restrict the users of a free program by obtaining a restrictive license from a patent holder. Therefore, we insist that any patent license obtained for a version of the library must be consistent with the full freedom of use specified in this license.

Most GNU software, including some libraries, is covered by the ordinary GNU General Public License. This license, the GNU Lesser General Public License, applies to certain designated libraries, and is quite different from the ordinary General Public License. We use this license for certain libraries in order to permit linking those libraries into non-free programs.

When a program is linked with a library, whether statically or using a shared library, the combination of the two is legally speaking a combined work, a derivative of the original library. The ordinary General Public License therefore permits such linking only if the entire combination fits its criteria of freedom. The Lesser General Public License permits more lax criteria for linking other code with the library.

We call this license the "Lesser" General Public License because it does Less to protect the user's freedom than the ordinary General Public License. It also provides other free software developers Less of an advantage over competing non-free programs. These disadvantages are the reason we use the ordinary General Public License for many libraries. However, the Lesser license provides advantages in certain special circumstances.

For example, on rare occasions, there may be a special need to encourage the widest possible use of a certain library, so that it becomes a de-facto standard. To achieve this, non-free programs must be allowed to use the library. A more frequent case is that a free library does the same job as widely used non-free libraries. In this case, there is little to gain by limiting the free library to free software only, so we use the Lesser General Public License. In other cases, permission to use a particular library in non-free programs enables a greater number of people to use a large body of free software. For example, permission to use the GNU C Library in non-free programs enables many more people to use the whole GNU operating system, as well as its variant, the GNU/Linux operating system.

Although the Lesser General Public License is Less protective of the users' freedom, it does ensure that the user of a program that is linked with the Library has the freedom and the wherewithal to run that program using a modified version of the Library.

The precise terms and conditions for copying, distribution and modification follow. Pay close attention to the difference between a "work based on the library" and a "work that uses the library". The former contains code derived from the library, whereas the latter must be combined with the library in order to run.

GNU LESSER GENERAL PUBLIC LICENSE TERMS AND CONDITIONS FOR COPYING, DISTRIBUTION AND MODIFICATION

0. This License Agreement applies to any software library or other program which contains a notice placed by the copyright holder or other authorized party saying it may be distributed under the terms of this Lesser General Public License (also called "this License").

Each licensee is addressed as "you".

A "library" means a collection of software functions and/or data prepared so as to be conveniently linked with application programs (which use some of those functions and data) to form executables. The "Library", below, refers to any such software library or work which has been distributed under these terms. A "work based on the Library" means either the Library or any derivative work under copyright law: that is to say, a work containing the Library or a portion of it, either verbatim or with modifications and/or translated straightforwardly into another language. (Hereinafter, translation is included without limitation in the term "modification".)

"Source code" for a work means the preferred form of the work for making modifications to it. For a library, complete source code means all the source code for all modules it contains, plus any associated interface definition files, plus the scripts used to control compilation and installation of the library. Activities other than copying, distribution and modification are not covered by this License; they

are outside its scope. The act of running a program using the Library is not restricted, and output from such a program is covered only if its contents constitute a work based on the Library (independent of the use of the Library in a tool for writing it). Whether that is true depends on what the Library does and what the program that uses the Library does.

1. You may copy and distribute verbatim copies of the Library's complete source code as you receive it, in any medium, provided that you conspicuously and appropriately publish on each copy an appropriate copyright notice and disclaimer of warranty; keep intact all the notices that refer to this License and to the absence of any warranty; and distribute a copy of this License along with the Library. You may charge a fee for the physical act of transferring a copy, and you may at your option offer warranty protection in exchange for a fee.

2. You may modify your copy or copies of the Library or any portion of it, thus forming a work based on the Library, and copy and distribute such modifications or work under the terms of Section 1 above, provided that you also meet all of these conditions: a) The modified work must itself be a software library. b) You must cause the files modified to carry prominent notices stating that you changed the files and the date of any change. c) You must cause the whole of the work to be licensed at no charge to all third parties under the terms of this License. d) If a facility in the modified Library refers to a function or a table of data to be supplied by an application program that uses the facility, other than as an argument passed when the facility is invoked, then you must make a good faith effort to ensure that, in the event an application does not supply such function or table, the facility still operates, and performs whatever part of its purpose remains meaningful. (For example, a function in a library to compute square roots has a purpose that is entirely well-defined independent of the application. Therefore, Subsection 2d requires that any application-supplied function or table used by this function must be optional: if the application does not supply it, the square root function must still compute square roots.) These requirements apply to the modified work as a whole. If identifiable sections of that work are not derived from the Library, and can be reasonably considered independent and separate works in themselves, then this License, and its terms, do not apply to those sections when you distribute them as separate works. But when you distribute the same sections as part of a whole which is a work based on the Library, the distribution of the whole must be on the terms of this License, whose permissions for other licensees extend to the entire whole, and thus to each and every part regardless of who wrote

it. Thus, it is not the intent of this section to claim rights or contest your rights to work written entirely by you; rather, the intent is to exercise the right to control the distribution of derivative or collective works based on the Library. In addition, mere aggregation of another work not based on the Library with the Library (or with a work based on the Library) on a volume of a storage or distribution medium does not bring the other work under the scope of this License.

3. You may opt to apply the terms of the ordinary GNU General Public License instead of this License to a given copy of the Library. To do this, you must alter all the notices that refer to this License, so that they refer to the ordinary GNU General Public License, version 2, instead of to this License. (If a newer version than version 2 of the ordinary GNU General Public License has appeared, then you can specify that version instead if you wish.) Do not make any other change in these notices. Once this change is made in a given copy, it is irreversible for that copy, so the ordinary GNU General Public License applies to all subsequent copies and derivative works made from that copy. This option is useful when you wish to copy part of the code of the Library into a program that is not a library.

4. You may copy and distribute the Library (or a portion or derivative of it, under Section 2) in object code or executable form under the terms of Sections 1 and 2 above provided that you accompany it with the complete corresponding machine-readable source code, which must be distributed under the terms of Sections 1 and 2 above on a medium customarily used for software interchange. If distribution of object code is made by offering access to copy from a designated place, then offering equivalent access to copy the source code from the same place satisfies the requirement to distribute the source code, even though third parties are not

compelled to copy the source along with the object code.

5. A program that contains no derivative of any portion of the Library, but is designed to work with the Library by being compiled or linked with it, is called a "work that uses the Library". Such a work, in isolation, is not a derivative work of the Library, and therefore falls outside the scope of this License.

However, linking a "work that uses the Library" with the Library creates an executable that is a derivative of the Library (because it contains portions of the Library), rather than a "work that uses the library". The executable is therefore covered by this License. Section 6 states terms for distribution of such executables. When a "work that uses the Library" uses material from a header file that is part of the Library, the object code for the work may be a derivative work of the Library even though the source code is not. Whether this is true is especially significant if the work can be linked without the Library, or if the work is itself a library. The threshold for this to be true is not precisely defined by law. If such an object file uses only numerical parameters, data structure layouts and accessors, and small macros and small inline functions (ten lines or less in length), then the use of the object file is unrestricted, regardless of whether it is legally a derivative work. (Executables containing this object code plus portions of the Library will still fall under Section 6.) Otherwise, if the work is a derivative of the Library, you may distribute the object code for the work under the terms of Section 6. Any executables containing that work also fall under Section 6, whether or not they are linked directly with the Library itself.

6. As an exception to the Sections above, you may also combine or link a "work that uses the Library" with the Library to produce a work containing portions of the Library, and distribute that work under terms of your choice, provided that the terms permit modification of the work for the customer's own use and reverse engineering for debugging such modifications. You must give prominent notice with each copy of the work that the Library is used in it and that the Library and its use are covered by this License. You must supply a copy of this License. If the work during execution displays copyright notices, you must include the copyright notice for the Library among them, as well as a reference directing the user to the copy of this License. Also, you must do one of these things: a) Accompany the work with the complete corresponding

machine-readable source code for the Library including whatever changes were used in the work (which must be distributed under Sections 1 and 2 above); and, if the work is an executable linked with the Library, with the complete machine-readable "work that uses the Library", as object code and/or source code, so that the user can modify the Library and then relink to produce a modified executable containing the modified Library. (It is understood that the user who changes the contents of definitions files in the Library will not necessarily be able to recompile the application to use the modified definitions.) b) Use a suitable shared library mechanism for linking with the Library. A suitable mechanism is one that (1) uses at run time a

copy of the library already present on the user's computer system, rather than copying library functions into the executable, and (2) will operate properly with a modified version of the library, if the user installs one, as long as the modified version is interface-compatible with the version that the work was made with. c) Accompany the work with a written offer, valid for at least three years, to give the same user the materials specified in Subsection 6a, above, for a charge no more than the cost of performing this distribution. d) If distribution of the work is made by offering access to copy from a designated place, offer equivalent access to copy the above specified materials from the same place. e) Verify that the user has already received a copy of these materials or that you have already sent this user a copy. For an executable, the required form of the "work that uses the Library" must include any data and utility programs needed for reproducing the executable from it. However, as a special exception, the materials to be distributed need not include anything that is normally distributed (in either source or binary form) with the major components (compiler, kernel, and so on) of the operating system on which the executable runs, unless that component itself accompanies the executable.

It may happen that this requirement contradicts the license restrictions of other proprietary libraries that do not normally accompany the operating system. Such a contradiction means you cannot use both them and the Library together in an executable that you distribute.

7. You may place library facilities that are a work based on the Library side-by-side in a single library together with other library facilities not covered by this License, and distribute such a combined library, provided that the separate distribution of the work based on the Library and of the other library facilities is otherwise permitted, and provided that you do these two things: a) Accompany the combined library with a copy of the same work based on the Library, uncombined with any other library facilities. This must be distributed under the terms of the Sections above. b) Give prominent notice with the combined library of the fact that part of it is a work based on the Library, and explaining where to find the accompanying uncombined form of the same work.

8. You may not copy, modify, sublicense, link with, or distribute the Library except as expressly provided under this License. Any attempt otherwise to copy, modify, sublicense, link with, or distribute the Library is void, and will automatically terminate your rights under this License. However, parties who have received copies, or rights, from you under this License will not have their licenses terminated so long as such parties remain in full compliance.

9. You are not required to accept this License, since you have not signed it. However, nothing else grants you permission to modify or distribute the Library or its derivative works. These actions are prohibited by law if you do not accept this License. Therefore, by modifying or distributing the Library (or any work based on the Library), you indicate your acceptance of this License to do so, and all its terms and conditions for copying, distributing or modifying the Library or works based on it.

10. Each time you redistribute the Library (or any work based on the Library), the recipient automatically receives a license from the original licensor to copy, distribute, link with or modify the Library subject to these terms and conditions. You may not impose any further restrictions on the recipients' exercise of the rights granted herein. You are not responsible for enforcing compliance by third parties with this License.

11. If, as a consequence of a court judgment or allegation of patent infringement or for any other reason (not limited to patent issues), conditions are imposed on you (whether by court order, agreement or otherwise) that contradict the conditions of this License, they do not excuse you from the conditions of this License. If you cannot distribute so as to satisfy simultaneously your obligations under this License and any other pertinent obligations, then as a consequence you may not distribute the Library at all. For example, if a patent license would not permit royalty-free redistribution of the Library by all those who receive copies directly or indirectly through you, then the only way you could satisfy both it and this License would be to

refrain entirely from distribution of the Library. If any portion of this section is held invalid or unenforceable under any particular circumstance, the balance of the section is intended to apply, and the section as a whole is intended to apply in

other circumstances. It is not the purpose of this section to induce you to infringe any patents or other property right claims or to contest validity of any such claims; this section has the sole purpose of protecting the integrity of the free software distribution system which is implemented by public license practices. Many people have made generous contributions to the wide range of software distributed through that system in reliance on consistent application of that system; it is up to the author/donor to decide if he or she is willing to distribute software through any other system and a licensee cannot impose that choice. This section is intended to make thoroughly clear what is believed to be a consequence of the rest of this License.

12. If the distribution and/or use of the Library is restricted in certain countries either by patents or by copyrighted interfaces, the original copyright holder who places the Library under this License may add an explicit geographical distribution limitation excluding those countries, so that distribution is permitted only in or among countries not thus excluded. In such case, this License incorporates the limitation as if written in the body of this License.

13. The Free Software Foundation may publish revised and/or new versions of the Lesser General Public License from time to time. Such new versions will be similar in spirit to the present version, but may differ in detail to address new problems or concerns. Each version is given a distinguishing version number. If the Library specifies a version number of this License which applies to it and "any later version", you have the option of following the terms and conditions either of that version or of any later version published by the Free Software Foundation. If the Library does not specify a license version number, you may choose any version ever published by the Free Software Foundation.

14. If you wish to incorporate parts of the Library into other free programs whose distribution conditions are incompatible with these, write to the author to ask for permission. For software which is copyrighted by the Free Software Foundation, write to the Free Software Foundation; we sometimes make exceptions for this. Our decision will be guided by the two goals of preserving the free status of all derivatives of our free software and of promoting the sharing

and reuse of software generally.

NO WARRANTY

15. BECAUSE THE LIBRARY IS LICENSED FREE OF CHARGE, THERE IS NO WARRANTY FOR THE LIBRARY, TO THE EXTENT PERMITTED BY APPLICABLE LAW. EXCEPT WHEN OTHERWISE STATED IN WRITING THE COPYRIGHT HOLDERS AND/OR OTHER PARTIES PROVIDE THE LIBRARY "AS IS" WITHOUT WARRANTY OF ANY KIND, EITHER EXPRESSED OR IMPLIED, INCLUDING, BUT NOT LIMITED TO, THE IMPLIED WARRANTIES OF MERCHANTABILITY AND FITNESS FOR A PARTICULAR PURPOSE. THE ENTIRE RISK AS TO THE QUALITY AND PERFORMANCE OF THE

LIBRARY IS WITH YOU. SHOULD THE LIBRARY PROVE DEFECTIVE, YOU ASSUME THE COST OF ALL NECESSARY SERVICING, REPAIR OR CORRECTION.

16. IN NO EVENT UNLESS REQUIRED BY APPLICABLE LAW OR AGREED TO IN WRITING WILL ANY COPYRIGHT HOLDER, OR ANY OTHER PARTY WHO MAY MODIFY AND/OR REDISTRIBUTE THE LIBRARY AS PERMITTED ABOVE, BE LIABLE TO YOU FOR DAMAGES, INCLUDING ANY GENERAL, SPECIAL, INCIDENTAL OR CONSEQUENTIAL DAMAGES ARISING OUT OF THE USE OR INABILITY TO USE THE LIBRARY (INCLUDING BUT NOT LIMITED TO LOSS OF DATA OR DATA BEING RENDERED INACCURATE OR LOSSES SUSTAINED BY YOU OR THIRD PARTIES OR A FAILURE OF THE LIBRARY TO OPERATE WITH ANY OTHER SOFTWARE), EVEN IF SUCH HOLDER OR OTHER PARTY HAS BEEN ADVISED OF THE POSSIBILITY OF SUCH DAMAGES.

END OF TERMS AND CONDITIONS.

This Product includes arp-sk, bridge-utils, busybox, dhcpcd, dhcp-helper, hostapd, wireless_tools, gd, libqsearch, ipset, samba, libeeprog, msmtmp, pam, pptp, ppp, proftpd, rp-pppoe, vlan, syslog-ng, tzcode, quagga, iproute2, iptables, Linux kernel, pcmcia, netkit-telnet, and libol software under GPL license.

GNU GENERAL PUBLIC LICENSE

Version 2, June 1991

Copyright (C) 1989, 1991 Free Software Foundation, Inc.

59 Temple Place - Suite 330, Boston, MA 02111-1307, USA

Everyone is permitted to copy and distribute verbatim copies of this license document, but changing it is not allowed.

Preamble

The licenses for most software are designed to take away your freedom to share and change it. By contrast, the GNU General Public License is intended to guarantee your freedom to share and change free software--to make sure the software is free for all its users. This General Public License applies to most of the Free Software Foundation's software and to any other program whose authors commit to using it. (Some other Free Software Foundation software is covered by the GNU Library General Public License instead.) You can apply it to your programs, too.

When we speak of free software, we are referring to freedom, not price. Our General Public Licenses are designed to make sure that you have the freedom to distribute copies of free software (and charge for this service if you wish), that you receive source code or can get it if you want it, that you can change the software

or use pieces of it in new free programs; and that you know you can do these things.

To protect your rights, we need to make restrictions that forbid anyone to deny you these rights or to ask you to surrender the rights. These restrictions translate to certain responsibilities for you if you distribute copies of the software, or if you modify it. For example, if you distribute copies of such a program, whether gratis or for a fee, you must give the recipients all the rights that you have. You must make sure that they, too, receive or can get the source code. And you must show them these terms so they know their rights.

We protect your rights with two steps: (1) copyright the software, and (2) offer you this license which gives you legal permission to copy, distribute and/or modify the software. Also, for each author's protection and ours, we want to make certain that everyone understands that there is no warranty for this free software. If the software is modified by someone else and passed on, we want its recipients to know that what they have is not the original, so that any problems introduced by others will not reflect on the original authors' reputations.

Finally, any free program is threatened constantly by software patents. We wish to avoid the danger that redistributors of a free program will individually obtain patent licenses, in effect making the program proprietary. To prevent this, we have made it clear that any patent must be licensed for everyone's free use or not licensed at all.

The precise terms and conditions for copying, distribution and modification follow.

TERMS AND CONDITIONS FOR COPYING, DISTRIBUTION AND MODIFICATION

0. This License applies to any program or other work which contains a notice placed by the copyright holder saying it may be distributed under the terms of this General Public License. The "Program", below, refers to any such program or work, and a "work based on the Program" means either the Program or any derivative work under copyright law: that is to say, a work containing the Program or a portion of it, either verbatim or with modifications and/or translated into another language. (Hereinafter, translation is included without limitation in the term "modification".) Each licensee is addressed as "you". Activities other than copying, distribution and modification are not covered by this License; they are outside its scope. The act of running the Program is not restricted, and the output from the Program is covered only if its contents constitute a work based on the Program (independent of having been made by running the Program). Whether that is true depends on what the Program does.

1. You may copy and distribute verbatim copies of the Program's source code as you receive it, in any medium, provided that you conspicuously and appropriately

publish on each copy an appropriate copyright notice and disclaimer of warranty; keep intact all the notices that refer to this License and to the absence of any warranty; and give any other recipients of the Program a copy of this License along with the Program. You may charge a fee for the physical act of transferring a copy, and you may at your option offer warranty protection in exchange for a fee.

2. You may modify your copy or copies of the Program or any portion of it, thus forming a work based on the Program, and copy and distribute such modifications or work under the terms of Section 1 above, provided that you also meet all of these conditions:

- a) You must cause the modified files to carry prominent notices stating that you changed the files and the date of any change.
- b) You must cause any work that you distribute or publish, that in whole or in part contains or is derived from the Program or any part thereof, to be licensed as a whole at no charge to all third parties under the terms of this License.
- c) If the modified program normally reads commands interactively when run, you must cause it, when started running for such interactive use in the most ordinary way, to print or display an announcement including an appropriate copyright notice and a notice that there is no warranty (or else, saying that you provide a warranty) and that users may redistribute the program under these conditions, and telling the user how to view a copy of this License. (Exception: if the Program itself is interactive but does not normally print such an announcement, your work based on the Program is not required to print an announcement.)

These requirements apply to the modified work as a whole. If identifiable sections of that work are not derived from the Program, and can be reasonably considered independent and separate works in themselves, then this License, and its terms, do not apply to those sections when you distribute them as separate works. But when you distribute the same sections as part of a whole which is a work based on the Program, the distribution of the whole must be on the terms of this License, whose permissions for other licensees extend to the entire whole, and thus to each and every part regardless of who wrote it. Thus, it is not the intent of this section to claim rights or contest your rights to work written entirely by you; rather, the intent is to exercise the right to control the distribution of derivative or collective works based on the Program. In addition, mere aggregation of another work not based on the Program with the Program (or with a work based on the Program) on a volume of a storage or distribution medium does not bring the other work under the scope of this License.

3. You may copy and distribute the Program (or a work based on it, under Section 2) in object code or executable form under the terms of Sections 1 and 2 above provided that you also do one of the following:

a) Accompany it with the complete corresponding machine-readable source code, which must be distributed under the terms of Sections 1 and 2 above on a medium customarily used for software interchange; or,

b) Accompany it with a written offer, valid for at least three years, to give any third party, for a charge no more than your cost of physically performing source distribution, a complete machine-readable copy of the corresponding source code, to be distributed under the terms of Sections 1 and 2 above on a medium customarily used for software interchange; or, c) Accompany it with the information you received as to the offer to distribute corresponding source code. (This alternative is allowed only for noncommercial distribution and only if you received the program in object code or executable form with such an offer, in accord with Subsection b above.) The source code for a work means the preferred form of the work for making modifications to it. For an executable work, complete source code means all the source code for all modules it contains, plus any associated interface definition files, plus the

scripts used to control compilation and installation of the executable. However, as a special exception, the source code distributed need not include anything that is normally distributed (in either source or binary form) with the major components (compiler, kernel, and so on) of the operating system on which the executable runs, unless that component itself accompanies the executable. If distribution of executable or object code is made by offering access to copy from a designated place, then offering equivalent access to copy the source code from the same place counts as distribution of the source code, even though third parties are not compelled to copy the source along with the object code.

4. You may not copy, modify, sublicense, or distribute the Program except as expressly provided under this License. Any attempt otherwise to copy, modify, sublicense or distribute the Program is void, and will automatically terminate your rights under this License. However, parties who have received copies, or rights, from you under this License will not have their licenses terminated so long as such parties remain in full compliance.

5. You are not required to accept this License, since you have not signed it. However, nothing else grants you permission to modify or distribute the Program or its derivative works. These actions are prohibited by law if you do not accept this License. Therefore, by modifying or distributing the Program (or any work based on the Program), you indicate your acceptance of this License to do so, and all its terms and conditions for copying, distributing or modifying the Program or works based on it.

6. Each time you redistribute the Program (or any work based on the Program), the recipient automatically receives a license from the original licensor to copy, distribute or modify the Program subject to these terms and conditions. You may not impose any further restrictions on the recipients' exercise of the rights granted

herein. You are not responsible for enforcing compliance by third parties to this License.

7. If, as a consequence of a court judgment or allegation of patent infringement or for any other reason (not limited to patent issues), conditions are imposed on you (whether by court order, agreement or otherwise) that contradict the conditions of this License, they do not excuse you from the conditions of this License. If you cannot distribute so as to satisfy simultaneously your obligations under this License and any other pertinent obligations, then as a consequence you may not distribute the Program at all. For example, if a patent license would not permit royalty-free redistribution of the Program by all those who receive copies directly or indirectly through you, then the only way you could satisfy both it and this License would be to refrain entirely from distribution of the Program. If any portion of this section is held invalid or unenforceable under any particular circumstance, the balance of the section is intended to apply and the section as a whole is intended to apply in other circumstances. It is not the purpose of this section to induce you to infringe any patents or other property right claims or to contest validity of any such claims; this section has the sole purpose of protecting the integrity of the free software distribution system, which is implemented by public license practices. Many people have made generous contributions to the wide range of software distributed through that system in reliance on consistent application of that system; it is up to the author/donor to decide if he or she is willing to distribute software through any other system and a licensee cannot impose that choice. This section is intended to make thoroughly clear what is believed to be a consequence of the rest of this License.

8. If the distribution and/or use of the Program is restricted in certain countries either by patents or by copyrighted interfaces, the original copyright holder who places the Program under this License may add an explicit geographical distribution limitation excluding those countries, so that distribution is permitted only in or among countries not thus excluded. In such case, this License incorporates the limitation as if written in the body of this License.

9. The Free Software Foundation may publish revised and/or new versions of the General Public License from time to time. Such new versions will be similar in spirit to the present version, but may differ in detail to address new problems or concerns. Each version is given a distinguishing version number. If the Program specifies a version number of this License which applies to it and "any later version", you have the option of following the terms and conditions either of that version or of any later version published by the Free Software Foundation. If the Program does not specify a version number of this License, you may choose any version ever published by the Free Software Foundation.

10. If you wish to incorporate parts of the Program into other free programs whose distribution conditions are different, write to the author to ask for permission. For software which is copyrighted by the Free Software Foundation, write to the Free Software Foundation; we sometimes make exceptions for this.

Our decision will be guided by the two goals of preserving the free status of all derivatives of our free software and of promoting the sharing and reuse of software generally.

NO WARRANTY

11. BECAUSE THE PROGRAM IS LICENSED FREE OF CHARGE, THERE IS NO WARRANTY FOR THE PROGRAM, TO THE EXTENT PERMITTED BY APPLICABLE LAW. EXCEPT WHEN OTHERWISE STATED IN WRITING THE COPYRIGHT HOLDERS AND/OR OTHER PARTIES PROVIDE THE PROGRAM "AS IS" WITHOUT WARRANTY OF ANY KIND, EITHER EXPRESSED OR IMPLIED, INCLUDING, BUT NOT LIMITED TO, THE IMPLIED WARRANTIES OF MERCHANTABILITY AND FITNESS FOR A PARTICULAR PURPOSE. THE ENTIRE RISK AS TO THE QUALITY AND PERFORMANCE OF THE PROGRAM IS WITH YOU. SHOULD THE PROGRAM PROVE DEFECTIVE, YOU ASSUME THE COST OF ALL NECESSARY SERVICING, REPAIR OR CORRECTION.

12. IN NO EVENT UNLESS REQUIRED BY APPLICABLE LAW OR AGREED TO IN WRITING WILL ANY COPYRIGHT HOLDER, OR ANY OTHER PARTY WHO MAY MODIFY AND/OR REDISTRIBUTE THE PROGRAM AS PERMITTED ABOVE, BE LIABLE TO YOU FOR DAMAGES, INCLUDING ANY GENERAL, SPECIAL, INCIDENTAL OR CONSEQUENTIAL DAMAGES ARISING OUT OF THE USE OR INABILITY TO USE THE PROGRAM (INCLUDING BUT NOT LIMITED TO LOSS OF DATA OR DATA BEING RENDERED INACCURATE OR LOSSES SUSTAINED BY YOU OR THIRD PARTIES OR A FAILURE OF THE PROGRAM TO OPERATE WITH ANY OTHER PROGRAMS), EVEN IF SUCH HOLDER OR OTHER PARTY HAS BEEN ADVISED OF THE POSSIBILITY OF SUCH DAMAGES.

END OF TERMS AND CONDITIONS

All other trademarks or trade names mentioned herein, if any, are the property of their respective owners.

This Product includes ppp, libpcap, hostapd, tcpdump, unzip, zip, libnet, net-snmp, openssh, and ftp-tls software under BSD license

BSD

Copyright (c) [dates as appropriate to package]

The Regents of the University of California. All rights reserved. Redistribution and use in source and binary forms, with or without modification, are permitted provided that the following conditions are met:

Redistributions of source code must retain the above copyright notice, this list of conditions and the following disclaimer.

Redistributions in binary form must reproduce the above copyright notice, this list of conditions and the following disclaimer in the documentation and/or other materials provided with the distribution.

Neither the name of the University nor of the Laboratory may be used to endorse or promote products derived from this software without specific prior written permission.

THIS SOFTWARE IS PROVIDED BY THE REGENTS AND CONTRIBUTORS ``AS IS'' AND ANY EXPRESS OR IMPLIED WARRANTIES, INCLUDING, BUT NOT LIMITED TO, THE IMPLIED WARRANTIES OF MERCHANTABILITY AND FITNESS FOR A PARTICULAR PURPOSE ARE DISCLAIMED. IN NO EVENT SHALL THE REGENTS OR CONTRIBUTORS BE LIABLE FOR ANY DIRECT, INDIRECT, INCIDENTAL, SPECIAL, EXEMPLARY, OR CONSEQUENTIAL DAMAGES (INCLUDING, BUT NOT LIMITED TO, PROCUREMENT OF SUBSTITUTE GOODS OR SERVICES; LOSS OF USE, DATA, OR PROFITS; OR BUSINESS INTERRUPTION) HOWEVER CAUSED AND ON ANY THEORY OF LIABILITY, WHETHER IN CONTRACT, STRICT LIABILITY, OR TORT (INCLUDING NEGLIGENCE OR OTHERWISE) ARISING IN ANY WAY OUT OF THE USE OF THIS SOFTWARE, EVEN IF ADVISED OF THE POSSIBILITY OF SUCH DAMAGE.

This Product includes libxml2, tablekit, prototype and persist-js software under the MIT License

The MIT License

Copyright (c) <year> <copyright holders>

Permission is hereby granted, free of charge, to any person obtaining a copy of this software and associated documentation files (the "Software"), to deal in the Software without restriction, including without limitation the rights to use, copy, modify, merge, publish, distribute, sublicense, and/or sell copies of the Software, and to permit persons to whom the Software is furnished to do so, subject to the following conditions:

The above copyright notice and this permission notice shall be included in all copies or substantial portions of the Software.

THE SOFTWARE IS PROVIDED "AS IS", WITHOUT WARRANTY OF ANY KIND, EXPRESS OR IMPLIED, INCLUDING BUT NOT LIMITED TO THE WARRANTIES OF MERCHANTABILITY, FITNESS FOR A PARTICULAR PURPOSE AND NONINFRINGEMENT. IN NO EVENT SHALL THE AUTHORS OR COPYRIGHT HOLDERS BE LIABLE FOR ANY CLAIM, DAMAGES OR OTHER LIABILITY, WHETHER IN AN ACTION OF CONTRACT, TORT OR OTHERWISE, ARISING FROM, OUT OF OR IN CONNECTION WITH THE SOFTWARE OR THE USE OR OTHER DEALINGS IN THE SOFTWARE.

This Product includes openldap software under the OpenLdap License

The Public License

Version 2.8, 17 August 2003

Redistribution and use of this software and associated documentation("Software"), with or without modification, are permitted provided that the following conditions are met:

1. Redistributions in source form must retain copyright statements and notices,
2. Redistributions in binary form must reproduce applicable copyright statements and notices, this list of conditions, and the following disclaimer in the documentation and/or other materials provided with the distribution, and
3. Redistributions must contain a verbatim copy of this document.

The OpenLDAP Foundation may revise this license from time to time. Each revision is distinguished by a version number. You may use this Software under terms of this license revision or under the terms of any subsequent revision of the license.

THIS SOFTWARE IS PROVIDED BY THE OPENLDAP FOUNDATION AND ITS CONTRIBUTORS ``AS IS'' AND ANY EXPRESSED OR IMPLIED WARRANTIES, INCLUDING, BUT NOT LIMITED TO, THE IMPLIED WARRANTIES OF MERCHANTABILITY AND FITNESS FOR A PARTICULAR PURPOSE ARE DISCLAIMED. IN NO EVENT SHALL THE OPENLDAP FOUNDATION, ITS CONTRIBUTORS, OR THE AUTHOR(S) OR OWNER(S) OF THE SOFTWARE BE LIABLE FOR ANY DIRECT, INDIRECT, INCIDENTAL, SPECIAL, EXEMPLARY, OR CONSEQUENTIAL DAMAGES (INCLUDING, BUT NOT LIMITED TO, PROCUREMENT OF SUBSTITUTE GOODS OR SERVICES; LOSS OF USE, DATA, OR PROFITS; OR BUSINESS INTERRUPTION) HOWEVER CAUSED AND ON ANY THEORY OF LIABILITY, WHETHER IN CONTRACT, STRICT LIABILITY, OR TORT (INCLUDING NEGLIGENCE OR OTHERWISE) ARISING IN ANY WAY OUT OF THE USE OF THIS SOFTWARE, EVEN IF ADVISED OF THE POSSIBILITY OF SUCH DAMAGE.

The names of the authors and copyright holders must not be used in advertising or otherwise to promote the sale, use or other dealing in this Software without specific, written prior permission. Title to copyright in this Software shall at all times remain with copyright holders.

OpenLDAP is a registered trademark of the OpenLDAP Foundation.

Copyright 1999-2003 The OpenLDAP Foundation, Redwood City, California, USA. All Rights Reserved. Permission to copy and distribute verbatim copies of this document is granted.

This Product includes libpng software under the Libpng License

This copy of the libpng notices is provided for your convenience. In case of any discrepancy between this copy and the notices in the file png.h that is included in the libpng distribution, the latter shall prevail.

COPYRIGHT NOTICE, DISCLAIMER, and LICENSE:

If you modify libpng you may insert additional notices immediately following this sentence.

This code is released under the libpng license.

libpng versions 1.2.6, August 15, 2004, through 1.4.1, February 25, 2010, are

Copyright (c) 2004, 2006-2007 Glenn Randers-Pehrson, and are distributed according to the same disclaimer and license as libpng-1.2.5 with the following individual added to the list of Contributing Authors

Cosmin Truta

libpng versions 1.0.7, July 1, 2000, through 1.2.5 - October 3, 2002, are Copyright (c) 2000-2002 Glenn Randers-Pehrson, and are distributed according to the same disclaimer and license as libpng-1.0.6 with the following individuals added to the list of Contributing Authors

Simon-Pierre Cadieux

Eric S. Raymond

Gilles Vollant

and with the following additions to the disclaimer:

There is no warranty against interference with your enjoyment of the library or against infringement. There is no warranty that our efforts or the library will fulfill any of your particular purposes or needs. This library is provided with all faults, and the entire risk of satisfactory quality, performance, accuracy, and effort is with the user.

libpng versions 0.97, January 1998, through 1.0.6, March 20, 2000, are Copyright (c) 1998, 1999 Glenn Randers-Pehrson, and are distributed according to the same disclaimer and license as libpng-0.96, with the following individuals added to the list of Contributing Authors:

Tom Lane

Glenn Randers-Pehrson

Willem van Schaik

libpng versions 0.89, June 1996, through 0.96, May 1997, are Copyright (c) 1996, 1997 Andreas Dilger Distributed according to the same disclaimer and license as

libpng-0.88, with the following individuals added to the list of Contributing Authors:

John Bowler
Kevin Bracey
Sam Bushell
Magnus Holmgren
Greg Roelofs
Tom Tanner

libpng versions 0.5, May 1995, through 0.88, January 1996, are Copyright (c) 1995, 1996 Guy Eric Schalnat, Group 42, Inc.

For the purposes of this copyright and license, "Contributing Authors" is defined as the following set of individuals:

Andreas Dilger
Dave Martindale
Guy Eric Schalnat
Paul Schmidt
Tim Wegner

The PNG Reference Library is supplied "AS IS". The Contributing Authors and Group 42, Inc. disclaim all warranties, expressed or implied, including, without limitation, the warranties of merchantability and of fitness for any purpose. The Contributing Authors and Group 42, Inc. assume no liability for direct, indirect, incidental, special, exemplary, or consequential damages, which may result from the use of the PNG

Reference Library, even if advised of the possibility of such damage.

Permission is hereby granted to use, copy, modify, and distribute this source code, or portions hereof, for any purpose, without fee, subject to the following restrictions:

1. The origin of this source code must not be misrepresented.
2. Altered versions must be plainly marked as such and must not be misrepresented as being the original source.
3. This Copyright notice may not be removed or altered from any source or altered source distribution.

The Contributing Authors and Group 42, Inc. specifically permit, without fee, and encourage the use of this source code as a component to supporting the PNG file

format in commercial products. If you use this source code in a product, acknowledgment is not required but would be appreciated.

A "png_get_copyright" function is available, for convenient use in "about" boxes and the like:

```
printf("%s",png_get_copyright(NULL));
```

Also, the PNG logo (in PNG format, of course) is supplied in the files "pngbar.png" and "pngbar.jpg (88x31) and "pngnow.png" (98x31).

Libpng is OSI Certified Open Source Software. OSI Certified Open Source is a certification mark of the Open Source Initiative.

Glenn Randers-Pehrson

glennrp at users.sourceforge.net

February 25, 2010

This Product includes libmd5-rfc software under the Zlib/libpng License

Copyright (c) <year> <copyright holders>

This software is provided 'as-is', without any express or implied warranty. In no event will the authors be held liable for any damages arising from the use of this software.

Permission is granted to anyone to use this software for any purpose, including commercial applications, and to alter it and redistribute it freely, subject to the following restrictions:

1. The origin of this software must not be misrepresented; you must not claim that you wrote the original software. If you use this software in a product, an acknowledgment in the product documentation would be appreciated but is not required.
2. Altered source versions must be plainly marked as such, and must not be misrepresented as being the original software.
3. This notice may not be removed or altered from any source distribution.

This Product includes pcmcia-cs software under the MPL License

Mozilla Public License Version 1.1

1. Definitions.

1.0.1. "Commercial Use"

means distribution or otherwise making the Covered Code available to a third party.

1.1. "Contributor"

means each entity that creates or contributes to the creation of Modifications.

1.2. "Contributor Version"

means the combination of the Original Code, prior Modifications used by a Contributor, and the Modifications made by that particular Contributor.

1.3. "Covered Code"

means the Original Code or Modifications or the combination of the Original Code and Modifications, in each case including portions thereof.

1.4. "Electronic Distribution Mechanism"

means a mechanism generally accepted in the software development community for the electronic transfer of data.

1.5. "Executable"

means Covered Code in any form other than Source Code.

1.6. "Initial Developer"

means the individual or entity identified as the Initial Developer in the Source Code notice required by Exhibit A.

1.7. "Larger Work"

means a work which combines Covered Code or portions thereof with code not governed by the terms of this License.

1.8. "License"

means this document.

1.8.1. "Licensable"

means having the right to grant, to the maximum extent possible, whether at the time of the initial grant or subsequently acquired, any and all of the rights conveyed herein.

1.9. "Modifications"

means any addition to or deletion from the substance or structure of either the Original Code or any previous Modifications. When Covered Code is released as a series of files, a Modification is:

- a. Any addition to or deletion from the contents of a file containing Original Code or previous Modifications.
- b. Any new file that contains any part of the Original Code or previous Modifications.

1.10. "Original Code"

means Source Code of computer software code which is described in the Source Code notice required by Exhibit A as Original Code, and which, at the time of its release under this License is not already Covered Code governed by this License.

1.10.1. "Patent Claims"

means any patent claim(s), now owned or hereafter acquired, including without limitation, method, process, and apparatus claims, in any patent Licensable by grantor.

1.11. "Source Code"

means the preferred form of the Covered Code for making modifications to it, including all modules it contains, plus any associated interface definition files, scripts used to control compilation and installation of an Executable, or source code differential comparisons against either the Original Code or another well known, available Covered Code of the Contributor's choice. The Source Code can be in a compressed or archival form, provided the appropriate decompression or de-archiving software is widely available for no charge.

1.12. "You" (or "Your")

means an individual or a legal entity exercising rights under, and complying with all of the terms of, this License or a future version of this License issued under Section 6.1. For legal entities, "You" includes any entity which controls, is controlled by, or is under common control with You. For purposes of this definition, "control" means (a) the power, direct or indirect, to cause the direction or management of such entity, whether by contract or otherwise, or (b) ownership of more than fifty percent (50%) of the outstanding shares or beneficial ownership of such entity.

2. Source Code License.

2.1. The Initial Developer Grant.

The Initial Developer hereby grants You a world-wide, royalty-free, non-exclusive license, subject to third party intellectual property claims:

- a. under intellectual property rights (other than patent or trademark) Licensable by Initial Developer to use, reproduce, modify, display, perform, sublicense and distribute the Original Code (or portions thereof) with or without Modifications, and/or as part of a Larger Work; and
- b. under Patents Claims infringed by the making, using or selling of Original Code, to make, have made, use, practice, sell, and offer for sale, and/or otherwise dispose of the Original Code (or portions thereof).
- c. the licenses granted in this Section 2.1 (a) and (b) are effective on the date Initial Developer first distributes Original Code under the terms of this License.
- d. Notwithstanding Section 2.1 (b) above, no patent license is granted: 1) for code that You delete from the Original Code; 2) separate from the Original Code; or 3) for infringements caused by: i) the modification of the Original Code or ii) the combination of the Original Code with other software or devices.

2.2. Contributor Grant.

Subject to third party intellectual property claims, each Contributor hereby grants You a world-wide, royalty-free, non-exclusive license

- a. under intellectual property rights (other than patent or trademark) Licensable by Contributor, to use, reproduce, modify, display, perform, sublicense and distribute the Modifications created by such Contributor (or portions thereof) either on an unmodified basis, with other Modifications, as Covered Code and/or as part of a Larger Work; and
- b. under Patent Claims infringed by the making, using, or selling of Modifications made by that Contributor either alone and/or in combination with its Contributor Version (or portions of such combination), to make, use, sell, offer for sale, have made, and/or otherwise dispose of: 1) Modifications made by that Contributor (or portions thereof); and 2) the combination of Modifications made by that Contributor with its Contributor Version (or portions of such combination).
- c. the licenses granted in Sections 2.2 (a) and 2.2 (b) are effective on the date Contributor first makes Commercial Use of the Covered Code.
- d. Notwithstanding Section 2.2 (b) above, no patent license is granted: 1) for any code that Contributor has deleted from the Contributor Version; 2) separate from the Contributor Version; 3) for infringements caused by: i) third party modifications of Contributor Version or ii) the combination of Modifications made by that Contributor with other software (except as part of the Contributor Version) or other devices; or 4) under Patent Claims infringed by Covered Code in the absence of Modifications made by that Contributor.

3. Distribution Obligations.

3.1. Application of License.

The Modifications which You create or to which You contribute are governed by the terms of this License, including without limitation Section 2.2. The Source Code version of Covered Code may be distributed only under the terms of this License or a future version of this License released under Section 6.1, and You must include a copy of this License with every copy of the Source Code You distribute. You may not offer or impose any terms on any Source Code version that alters or restricts the applicable version of this License or the recipients' rights hereunder. However, You may include an additional document offering the additional rights described in Section 3.5.

3.2. Availability of Source Code.

Any Modification which You create or to which You contribute must be made available in Source Code form under the terms of this License either on the same media as an Executable version or via an accepted Electronic Distribution Mechanism to anyone to whom you made an Executable version available; and if made available via Electronic Distribution Mechanism, must remain available for at least twelve (12) months after the date it initially became available, or at least six (6) months after a subsequent version of that particular Modification has been made available to such recipients. You are responsible for ensuring that the Source Code version remains available even if the Electronic Distribution Mechanism is maintained by a third party.

3.3. Description of Modifications.

You must cause all Covered Code to which You contribute to contain a file documenting the changes You made to create that Covered Code and the date of any change. You must include a prominent statement that the Modification is derived, directly or indirectly, from Original Code provided by the Initial Developer and including the name of the Initial Developer in (a) the Source Code, and (b) in any notice in an Executable version or related documentation in which You describe the origin or ownership of the Covered Code.

3.4. Intellectual Property Matters

(a) Third Party Claims

If Contributor has knowledge that a license under a third party's intellectual property rights is required to exercise the rights granted by such Contributor under Sections 2.1 or 2.2, Contributor must include a text file with the Source Code distribution titled "LEGAL" which describes the claim and the party making the claim in sufficient detail that a recipient will know whom to contact. If Contributor obtains such knowledge after the Modification is made available as described in Section 3.2, Contributor shall promptly modify the LEGAL file in all copies Contributor makes available thereafter and shall take other steps (such as notifying appropriate mailing lists or newsgroups) reasonably calculated to inform those who received the Covered Code that new knowledge has been obtained.

(b) Contributor APIs

If Contributor's Modifications include an application programming interface and Contributor has knowledge of patent licenses which are reasonably necessary to implement that API, Contributor must also include this information in the legal file.

(c) Representations.

Contributor represents that, except as disclosed pursuant to Section 3.4 (a) above, Contributor believes that Contributor's Modifications are Contributor's original creation(s) and/or Contributor has sufficient rights to grant the rights conveyed by this License.

3.5. Required Notices.

You must duplicate the notice in Exhibit A in each file of the Source Code. If it is not possible to put such notice in a particular Source Code file due to its structure, then You must include such notice in a location (such as a relevant directory) where a user would be likely to look for such a notice. If You created one or more Modification(s) You may add your name as a Contributor to the notice described in Exhibit A. You must also duplicate this License in any documentation for the Source Code where You describe recipients' rights or ownership rights relating to Covered Code. You may choose to offer, and to charge a fee for, warranty, support, indemnity or liability obligations to one or more recipients of Covered Code. However, You may do so only on Your own behalf, and not on behalf of the Initial Developer or any Contributor. You must make it absolutely clear than any such warranty, support, indemnity or liability obligation is offered by You alone, and You hereby agree to indemnify the Initial Developer and every Contributor for any liability incurred by the Initial Developer or such Contributor as a result of warranty, support, indemnity or liability terms You offer.

3.6. Distribution of Executable Versions.

You may distribute Covered Code in Executable form only if the requirements of Sections 3.1, 3.2, 3.3, 3.4 and 3.5 have been met for that Covered Code, and if You include a notice stating that the Source Code version of the Covered Code is available under the terms of this License, including a description of how and where You have fulfilled the obligations of Section 3.2. The notice must be conspicuously included in any notice in an Executable version, related documentation or collateral in which You describe recipients' rights relating to the Covered Code. You may distribute the Executable version of Covered Code or ownership rights under a license of Your choice, which may contain terms different from this License, provided that You are in compliance with the terms of this License and that the license for the Executable version does not attempt to limit or alter the recipient's rights in the Source Code version from the rights set forth in this License. If You distribute the Executable version under a different license You must make it absolutely clear that any terms which differ from this License are offered by You

alone, not by the Initial Developer or any Contributor. You hereby agree to indemnify the Initial Developer and every Contributor for any liability incurred by the Initial Developer or such Contributor as a result of any such terms You offer.

3.7. Larger Works.

You may create a Larger Work by combining Covered Code with other code not governed by the terms of this License and distribute the Larger Work as a single product. In such a case, You must make sure the requirements of this License are fulfilled for the Covered Code.

4. Inability to Comply Due to Statute or Regulation.

If it is impossible for You to comply with any of the terms of this License with respect to some or all of the Covered Code due to statute, judicial order, or regulation then You must: (a) comply with the terms of this License to the maximum extent possible; and (b) describe the limitations and the code they affect. Such description must be included in the legal file described in Section 3.4 and must be included with all distributions of the Source Code. Except to the extent prohibited by statute or regulation, such description must be sufficiently detailed for a recipient of ordinary skill to be able to understand it.

5. Application of this License.

This License applies to code to which the Initial Developer has attached the notice in Exhibit A and to related Covered Code.

6. Versions of the License.

6.1. New Versions

Netscape Communications Corporation ("Netscape") may publish revised and/or new versions of the License from time to time. Each version will be given a distinguishing version number.

6.2. Effect of New Versions

Once Covered Code has been published under a particular version of the License, You may always continue to use it under the terms of that version. You may also choose to use such Covered Code under the terms of any subsequent version of the License published by Netscape. No one other than Netscape has the right to modify the terms applicable to Covered Code created under this License.

6.3. Derivative Works

If You create or use a modified version of this License (which you may only do in order to apply it to code which is not already Covered Code governed by this License), You must (a) rename Your license so that the phrases "Mozilla",

"MOZILLAPL", "MOZPL", "Netscape", "MPL", "NPL" or any confusingly similar phrase do not appear in your license (except to note that your license differs from this License) and (b) otherwise make it clear that Your version of the license contains terms which differ from the Mozilla Public License and Netscape Public License. (Filling in the name of the Initial Developer, Original Code or Contributor in the notice described in Exhibit A shall not of themselves be deemed to be modifications of this License.)

7. Disclaimer of warranty

Covered code is provided under this license on an "as is" basis, without warranty of any kind, either expressed or implied, including, without limitation, warranties that the covered code is free of defects, merchantable, fit for a particular purpose or non-infringing. The entire risk as to the quality and performance of the covered code is with you. Should any covered code prove defective in any respect, you (not the initial developer or any other contributor) assume the cost of any necessary servicing, repair or correction. This disclaimer of warranty constitutes an essential part of this license. No use of any covered code is authorized hereunder except under this disclaimer.

8. Termination

8.1. This License and the rights granted hereunder will terminate automatically if You fail to comply with terms herein and fail to cure such breach within 30 days of becoming aware of the breach. All sublicenses to the Covered Code which are properly granted shall survive any termination of this License. Provisions which, by their nature, must remain in effect beyond the termination of this License shall survive.

8.2. If You initiate litigation by asserting a patent infringement claim (excluding declaratory judgment actions) against Initial Developer or a Contributor (the Initial Developer or Contributor against whom You file such action is referred to as "Participant") alleging that:

- a. such Participant's Contributor Version directly or indirectly infringes any patent, then any and all rights granted by such Participant to You under Sections 2.1 and/or 2.2 of this License shall, upon 60 days notice from Participant terminate prospectively, unless if within 60 days after receipt of notice You either: (i) agree in writing to pay Participant a mutually agreeable reasonable royalty for Your past and future use of Modifications made by such Participant, or (ii) withdraw Your litigation claim with respect to the Contributor Version against such Participant. If within 60 days of notice, a reasonable royalty and

payment arrangement are not mutually agreed upon in writing by the parties or the litigation claim is not withdrawn, the rights granted by Participant to You under Sections 2.1 and/or 2.2 automatically terminate at the expiration of the 60 day notice period specified above.

b. any software, hardware, or device, other than such Participant's Contributor Version, directly or indirectly infringes any patent, then any rights granted to You by such Participant under Sections 2.1(b) and 2.2(b) are revoked effective as of the date You first made, used, sold, distributed, or had made, Modifications made by that Participant.

8.3. If You assert a patent infringement claim against Participant alleging that such Participant's Contributor Version directly or indirectly infringes any patent where such claim is resolved (such as by license or settlement) prior to the initiation of patent infringement litigation, then the reasonable value of the licenses granted by such Participant under Sections 2.1 or 2.2 shall be taken into account in determining the amount or value of any payment or license.

8.4. In the event of termination under Sections 8.1 or 8.2 above, all end user license agreements (excluding distributors and resellers) which have been validly granted by You or any distributor hereunder prior to termination shall survive termination.

9. Limitation of liability

Under no circumstances and under no legal theory, whether tort (including negligence), contract, or otherwise, shall you, the initial developer, any other contributor, or any distributor of covered code, or any supplier of any of such parties, be liable to any person for any indirect, special, incidental, or consequential damages of any character including, without limitation, damages for loss of goodwill, work stoppage, computer failure or malfunction, or any and all other commercial damages or losses, even if such party shall have been informed of the possibility of such damages. This limitation of liability shall not apply to liability for death or personal injury resulting from such party's negligence to the extent applicable law prohibits such limitation. Some jurisdictions do not allow the exclusion or limitation of incidental or consequential damages, so this exclusion and limitation may not apply to you.

10. U.S. government end users

The Covered Code is a "commercial item," as that term is defined in 48 C.F.R. 2.101 (Oct. 1995), consisting of "commercial computer software" and "commercial computer software documentation," as such terms are used in 48 C.F.R. 12.212 (Sept. 1995). Consistent with 48 C.F.R. 12.212 and 48 C.F.R. 227.7202-1 through 227.7202-4 (June 1995), all U.S. Government End Users acquire Covered Code with only those rights set forth herein.

11. Miscellaneous

This License represents the complete agreement concerning subject matter hereof. If any provision of this License is held to be unenforceable, such provision shall be reformed only to the extent necessary to make it enforceable. This License shall be governed by California law provisions (except to the extent applicable law, if any, provides otherwise), excluding its conflict-of-law provisions. With respect to disputes in which at least one party is a citizen of, or an entity chartered or registered to do business in the United States of America, any litigation relating to this License shall be subject to the jurisdiction of the Federal Courts of the Northern District of California, with venue lying in Santa Clara County, California, with the losing party responsible for costs, including without limitation, court costs and reasonable attorneys' fees and expenses. The application of the United Nations Convention on Contracts for the International Sale of Goods is expressly excluded. Any law or regulation which provides that the language of a contract shall be construed against the drafter shall not apply to this License.

12. Responsibility for claims

As between Initial Developer and the Contributors, each party is responsible for claims and damages arising, directly or indirectly, out of its utilization of rights under this License and You agree to work with Initial Developer and Contributors to distribute such responsibility on an equitable basis. Nothing herein is intended or shall be deemed to constitute any admission of liability.

13. Multiple-licensed code

Initial Developer may designate portions of the Covered Code as "Multiple-Licensed". "Multiple-Licensed" means that the Initial Developer permits you to utilize portions of the Covered Code under Your choice of the MPL or the alternative licenses, if any, specified by the Initial Developer in the file described in Exhibit A.

Exhibit A - Mozilla Public License.

"The contents of this file are subject to the Mozilla Public License

Version 1.1 (the "License"); you may not use this file except in

compliance with the License. You may obtain a copy of the License at

<http://www.mozilla.org/MPL/>

Software distributed under the License is distributed on an "AS IS" basis, WITHOUT WARRANTY OF ANY KIND, either express or implied. See the License for the specific language governing rights and limitations under the License.

The Original Code is _____.

The Initial Developer of the Original Code is _____.

Portions created by _____ are Copyright (C) _____
_____. All Rights Reserved.

Contributor(s): _____.

Alternatively, the contents of this file may be used under the terms of the _____ license (the "[_____] License"), in which case the provisions of [_____] License are applicable instead of those above. If you wish to allow use of your version of this file only under the terms of the [_____] License and not to allow others to use your version of this file under the MPL, indicate your decision by deleting the provisions above and replace them with the notice and other provisions required by the [_____] License. If you do not delete the provisions above, a recipient may use your version of this file under either the MPL or the [_____] License."

NOTE: The text of this Exhibit A may differ slightly from the text of the notices in the Source Code files of the Original Code. You should use the text of this Exhibit A rather than the text found in the Original Code Source Code for Your Modifications.

Legal Information

Copyright

Copyright © 2011 by ZyXEL Communications Corporation.

The contents of this publication may not be reproduced in any part or as a whole, transcribed, stored in a retrieval system, translated into any language, or transmitted in any form or by any means, electronic, mechanical, magnetic, optical, chemical, photocopying, manual, or otherwise, without the prior written permission of ZyXEL Communications Corporation.

Published by ZyXEL Communications Corporation. All rights reserved.

Disclaimer

ZyXEL does not assume any liability arising out of the application or use of any products, or software described herein. Neither does it convey any license under its patent rights nor the patent rights of others. ZyXEL further reserves the right to make changes in any products described herein without notice. This publication is subject to change without notice.

Your use of the ZyWALL is subject to the terms and conditions of any related service providers.

Trademarks

ZyNOS (ZyXEL Network Operating System) is a registered trademark of ZyXEL Communications, Inc. Other trademarks mentioned in this publication are used for identification purposes only and may be properties of their respective owners.

Certifications (Class B)

Federal Communications Commission (FCC) Interference Statement

The device complies with Part 15 of FCC rules. Operation is subject to the following two conditions:

- This device may not cause harmful interference.
- This device must accept any interference received, including interference that may cause undesired operations.

This device has been tested and found to comply with the limits for a Class B digital device pursuant to Part 15 of the FCC Rules. These limits are designed to provide reasonable protection against harmful interference in a residential installation. This device generates, uses, and can radiate radio frequency energy, and if not installed and used in accordance with the instructions, may cause harmful interference to radio communications. However, there is no guarantee that interference will not occur in a particular installation.

If this device does cause harmful interference to radio/television reception, which can be determined by turning the device off and on, the user is encouraged to try to correct the interference by one or more of the following measures:

- 1 Reorient or relocate the receiving antenna.
- 2 Increase the separation between the equipment and the receiver.
- 3 Connect the equipment into an outlet on a circuit different from that to which the receiver is connected.
- 4 Consult the dealer or an experienced radio/TV technician for help.



FCC Radiation Exposure Statement

- This transmitter must not be co-located or operating in conjunction with any other antenna or transmitter.

注意！

依據 低功率電波輻射性電機管理辦法

第十二條 經型式認證合格之低功率射頻電機，非經許可，公司、商號或使用者均不得擅自變更頻率、加大功率或變更原設計之特性及功能。

第十四條 低功率射頻電機之使用不得影響飛航安全及干擾合法通信；經發現有干擾現象時，應立即停用，並改善至無干擾時方得繼續使用。前項合法通信，指依電信規定作業之無線電信。低功率射頻電機須忍受合法通信或工業、科學及醫療用電波輻射性電機設備之干擾。

Notices

Changes or modifications not expressly approved by the party responsible for compliance could void the user's authority to operate the equipment.

This Class B digital apparatus complies with Canadian ICES-003.

Cet appareil numérique de la classe B est conforme à la norme NMB-003 du Canada.

Viewing Certifications

- 1 Go to <http://www.zyxel.com>.
- 2 Select your product on the ZyXEL home page to go to that product's page.
- 3 Select the certification you wish to view from this page.

ZyXEL Limited Warranty

ZyXEL warrants to the original end user (purchaser) that this product is free from any defects in material or workmanship for a specific period (the Warranty Period) from the date of purchase. The Warranty Period varies by region. Check with your vendor and/or the authorized ZyXEL local distributor for details about the Warranty Period of this product. During the warranty period, and upon proof of purchase, should the product have indications of failure due to faulty workmanship and/or materials, ZyXEL will, at its discretion, repair or replace the defective products or components without charge for either parts or labor, and to whatever extent it shall deem necessary to restore the product or components to proper operating condition. Any replacement will consist of a new or re-manufactured functionally equivalent product of equal or higher value, and will be solely at the discretion of ZyXEL. This warranty shall not apply if the product has been modified, misused, tampered with, damaged by an act of God, or subjected to abnormal working conditions.

Note

Repair or replacement, as provided under this warranty, is the exclusive remedy of the purchaser. This warranty is in lieu of all other warranties, express or implied, including any implied warranty of merchantability or fitness for a particular use or purpose. ZyXEL shall in no event be held liable for indirect or consequential damages of any kind to the purchaser.

To obtain the services of this warranty, contact your vendor. You may also refer to the warranty policy for the region in which you bought the device at http://www.zyxel.com/web/support_warranty_info.php.

Registration

Register your product online to receive e-mail notices of firmware upgrades and information at www.zyxel.com.

Index

Symbols

Numerics

3322 Dynamic DNS [331](#)

3DES [416](#)

3G [111](#)

3G see also cellular [239](#)

A

AAA

Base DN [576](#)

Bind DN [576](#), [579](#)

directory structure [575](#)

Distinguished Name, see DN

DN [576](#), [577](#), [579](#), [580](#)

password [579](#)

port [578](#), [581](#)

search time limit [579](#)

SSL [579](#)

AAA server [573](#)

AD [575](#)

and users [540](#)

directory service [573](#)

LDAP [573](#), [575](#)

local user database [575](#)

object, where used [104](#)

RADIUS [574](#), [575](#), [579](#)

RADIUS group [581](#)

see also RADIUS

access [43](#)

Access Point Name, see APN

access point, See AP [248](#)

access users [540](#), [541](#)

custom page [650](#)

forcing login [366](#)

idle timeout [549](#)

logging in [366](#)

multiple logins [550](#)

see also users [540](#)

Web Configurator [552](#)

access users, see also force user authentication policies

account

myZyXEL.com [213](#)

user [539](#)

accounting server [573](#)

Active Directory, see AD

active protocol [421](#)

AH [421](#)

and encapsulation [422](#)

ESP [421](#)

active sessions [169](#), [173](#), [186](#)

ActiveX [510](#)

AD [573](#), [576](#), [577](#), [579](#), [580](#)

directory structure [575](#)

Distinguished Name, see DN

password [579](#)

port [578](#), [581](#)

search time limit [579](#)

SSL [579](#)

address groups [555](#)

and content filtering [487](#), [488](#), [493](#)

and firewall [370](#), [386](#)

and FTP [670](#)

and SNMP [674](#)

and SSH [665](#)

and Telnet [668](#)

and WWW [650](#)

where used [104](#)

address objects [555](#)

and content filtering [487](#), [488](#), [493](#)

and firewall [370](#), [386](#)

and FTP [670](#)

and NAT [306](#), [341](#)

and policy routes [304](#)

and SNMP [674](#)

and SSH [665](#)

and Telnet [668](#)

- and VPN connections [394](#)
- and WWW [650](#)
- HOST [555](#)
- RANGE [556](#)
- SUBNET [556](#)
- types of [555](#)
- where used [104](#)
- address record [640](#)
- admin user
 - troubleshooting [735](#)
- admin users [539](#)
 - multiple logins [550](#)
 - see also users [539](#)
- ADP [467](#)
 - base profiles [468](#), [471](#)
 - configuration overview [102](#)
 - false negatives [472](#)
 - false positives [472](#)
 - inline profile [472](#)
 - monitor profile [472](#)
 - port scanning [479](#)
 - prerequisites [102](#)
 - protocol anomaly [468](#)
 - traffic anomaly [468](#), [472](#)
- Advanced Encryption Standard, see AES
- AES [416](#), [813](#)
- AF [309](#)
- AH [399](#), [421](#)
 - and transport mode [422](#)
- alerts [682](#), [685](#), [686](#), [689](#), [690](#), [691](#)
 - anti-spam [526](#)
- ALG [351](#), [357](#)
 - and firewall [351](#), [354](#)
 - and NAT [352](#), [354](#)
 - and policy routes [353](#), [354](#), [357](#)
 - and trunks [357](#)
 - configuration overview [100](#)
 - FTP [352](#)
 - H.323 [352](#), [358](#)
 - peer-to-peer calls [353](#)
 - RTP [358](#)
 - see also VoIP pass through [352](#)
 - SIP [352](#)
 - tutorial [132](#)
- Anomaly Detection and Prevention, see ADP
- antenna
 - directional [818](#)
 - gain [817](#)
 - omni-directional [818](#)
- anti-spam [521](#), [527](#)
 - action for spam mails [527](#)
 - alerts [526](#)
 - black list [522](#), [527](#)
 - concurrent e-mail sessions [205](#), [524](#)
 - configuration overview [103](#)
 - DNSBL [523](#), [527](#), [532](#)
 - e-mail header buffer [523](#)
 - e-mail headers [522](#)
 - excess e-mail sessions [524](#)
 - general settings [523](#)
 - identifying legitimate e-mail [521](#)
 - identifying spam [522](#)
 - log options [526](#)
 - mail sessions threshold [524](#)
 - POP2 [522](#)
 - POP3 [522](#)
 - prerequisites [103](#)
 - priority [525](#)
 - regular expressions [530](#)
 - SMTP [522](#)
 - statistics [204](#)
 - status [206](#)
 - white list [521](#), [527](#), [529](#), [531](#)
- AP (Access Point) [248](#), [805](#)
- Apache server [483](#), [484](#)
- Apache-whitespace attack [483](#)
- APN [243](#)
- Application Layer Gateway, see ALG
- application order [91](#)
- applications [39](#)
- ASAS (Authenex Strong Authentication System) [574](#)
- ASCII-encoding [483](#)
- ASCII-encoding attacks [483](#)
- asymmetrical routes [381](#)
 - allowing through the firewall [383](#)
 - vs virtual interfaces [381](#)
- ATC [251](#)
- ATC+WMM [251](#)
- attacks
 - Apache-whitespace [483](#)
 - ASCII-encoding [483](#)
 - bare byte encoding [483](#)
 - base36-encoding [483](#)
 - Denial of Service (DoS) [398](#)
 - directory traversal [483](#)

- double-encoding [484](#)
- IIS-backslash-evasion [484](#)
- IIS-unicode-codepoint-encoding [484](#)
- multi-slash-encoding [484](#)
- network-based [38](#)
- non-RFC-defined-char [484](#)
- non-RFC-HTTP-delimiter [484](#)
- obsolete-options [485](#)
- oversize-chunk-encoding [484](#)
- oversize-len [485](#)
- oversize-offset [485](#)
- oversize-request-uri-directory [484](#)
- self-directory-traversal attack [484](#)
- truncated-address-header [485](#)
- truncated-header [485](#), [486](#)
- truncated-options [485](#)
- truncated-timestamp-header [486](#)
- TTCP-detected [485](#)
- u-encoding [484](#)
- undersize-len [485](#)
- undersize-offset [485](#)
- UTF-8-encoding [484](#)
- Authenex Strong Authentication System (ASAS) [574](#)
- authentication
 - in IPSec [400](#)
 - LDAP/AD [575](#)
 - server [573](#)
- authentication algorithms [325](#), [415](#), [416](#)
 - and active protocol [416](#)
 - and routing protocols [325](#)
 - MD5 [325](#), [416](#)
 - SHA1 [416](#)
 - text [325](#)
- Authentication Header, see AH
- authentication method objects [583](#)
 - and users [540](#)
 - and WWW [649](#)
 - create [585](#)
 - example [583](#)
 - where used [104](#)
- authentication policy [365](#)
 - exceptional services [368](#)
- authentication type [73](#), [613](#)
- Authentication, Authorization, Accounting servers, see AAA server
- authorization server [573](#)

B

- backing up configuration files [696](#)
- backslashes [484](#)
- bad-length-options attack [485](#)
- bandwidth
 - egress [245](#)
 - ingress [245](#)
- bandwidth limit
 - troubleshooting [730](#)
- bandwidth management
 - and policy routes [307](#)
 - interface, outbound, see interfaces
 - maximize bandwidth usage [307](#), [311](#), [457](#)
 - see also policy routes
- bare byte encoding [483](#)
- bare byte encoding attack [483](#)
- Base DN [576](#)
- base profiles
 - in ADP [468](#), [471](#)
- base36-encoding [483](#)
- base36-encoding attack [483](#)
- Basic Service Set, See BSS [803](#)
- Bind DN [576](#), [579](#)
- black list [527](#)
 - anti-spam [522](#)
- bookmarks [444](#)
- boot module [701](#)
- bridge interfaces [218](#), [275](#)
 - and virtual interfaces of members [275](#)
 - basic characteristics [219](#)
 - effect on routing table [275](#)
 - member interfaces [275](#)
- bridges [274](#)
- BSS [803](#)

C

- CA [811](#)
 - and certificates [590](#)
- CA (Certificate Authority), see certificates
- capturing packets [707](#)
- card SIM [244](#)
- CEF (Common Event Format) [683](#), [689](#)

- cellular [111](#), [239](#)
 - APN [243](#)
 - band selection [246](#)
 - interfaces [218](#)
 - signal quality [194](#), [195](#)
 - SIM card [244](#)
 - status [195](#)
 - system [194](#), [195](#)
 - troubleshooting [729](#), [730](#)
- Centralized Network Management
 - see Vantage CNM [630](#), [674](#)
- certificate
 - troubleshooting [736](#)
- Certificate Authority (CA) [811](#)
 - see certificates
- Certificate Management Protocol (CMP) [597](#)
- Certificate Revocation List (CRL) [590](#)
 - vs OCSP [609](#)
- certificates [589](#)
 - advantages of [590](#)
 - and CA [590](#)
 - and FTP [669](#)
 - and HTTPS [645](#)
 - and IKE SA [421](#)
 - and SSH [664](#)
 - and VPN gateways [394](#)
 - and WWW [648](#)
 - certification path [590](#), [600](#), [606](#)
 - expired [590](#)
 - factory-default [591](#)
 - file formats [591](#)
 - fingerprints [601](#), [607](#)
 - importing [594](#)
 - in IPSec [410](#)
 - not used for encryption [590](#)
 - revoked [590](#)
 - self-signed [590](#), [596](#)
 - serial number [600](#), [607](#)
 - storage space [593](#), [603](#)
 - thumbprint algorithms [592](#)
 - thumbprints [592](#)
 - used for authentication [590](#)
 - verifying fingerprints [591](#)
 - where used [104](#)
- certification requests [597](#)
- certifications
 - notices [937](#)
 - viewing [937](#)
- Challenge Handshake Authentication Protocol (CHAP) [613](#)
- channel [249](#), [805](#)
 - interference [805](#)
- CHAP (Challenge Handshake Authentication Protocol) [613](#)
- CHAP/PAP [613](#)
- checking order [91](#)
- CLI [33](#), [54](#)
 - button [54](#)
 - messages [54](#)
 - popup window [54](#)
 - Reference Guide [3](#)
- client [449](#)
- CNM [675](#)
- cold start [34](#)
- commands [33](#)
 - sent by Web Configurator [54](#)
- Common Event Format (CEF) [683](#), [689](#)
- common services [799](#)
- compression (stac) [614](#)
- computer names [230](#), [256](#), [271](#), [281](#), [287](#)
- concurrent e-mail sessions [205](#), [524](#)
- configuration
 - information [705](#), [712](#)
 - object-based [87](#)
 - overview [95](#)
 - web-based SSL application example [616](#)
- configuration file
 - troubleshooting [737](#)
- configuration files [693](#)
 - at restart [696](#)
 - backing up [696](#)
 - downloading [697](#)
 - downloading with FTP [668](#)
 - editing [693](#)
 - how applied [694](#)
 - lastgood.conf [696](#), [700](#)
 - managing [696](#)
 - not stopping or starting the ZyWALL [35](#)
 - startup-config.conf [700](#)
 - startup-config-bad.conf [696](#)
 - syntax [694](#)
 - system-default.conf [700](#)
 - uploading [700](#)
 - uploading with FTP [668](#)
 - use without restart [693](#)

connection
 troubleshooting [732](#)
 connection monitor (in SSL) [198](#)
 connectivity check [228](#), [238](#), [245](#), [270](#), [282](#), [400](#)
 console port [34](#)
 speed [636](#)
 content filter
 troubleshooting [728](#)
 content filtering [487](#), [488](#)
 and address groups [487](#), [488](#), [493](#)
 and address objects [487](#), [488](#), [493](#)
 and registration [492](#), [494](#), [497](#)
 and schedules [487](#), [488](#)
 and user groups [487](#)
 and users [487](#)
 by category [488](#), [499](#)
 by keyword (in URL) [488](#), [511](#)
 by URL [488](#), [510](#)
 by web feature [488](#), [509](#)
 cache [202](#), [512](#)
 categories [499](#)
 category service [497](#)
 configuration overview [102](#)
 default policy [488](#), [490](#)
 external web filtering service [497](#), [512](#)
 filter list [488](#)
 managed web pages [498](#)
 message for blocked access [491](#)
 policies [487](#), [488](#)
 prerequisites [102](#)
 registration status [215](#), [492](#), [497](#)
 reports, see content filtering reports
 statistics [200](#)
 testing [507](#)
 trial service activation [213](#)
 uncategorized pages [498](#)
 unsafe web pages [498](#)
 URL for blocked access [491](#)
 content filtering reports [513](#)
 and registration [513](#)
 during trial service [513](#)
 how to view [513](#)
 see also content filtering
 cookies [43](#), [510](#)
 copyright [935](#)
 CPU usage [169](#), [171](#)
 CTS (Clear to Send) [806](#)
 current date/time [168](#), [631](#)

 and schedules [567](#)
 daylight savings [633](#)
 setting manually [635](#)
 time server [635](#)
 current user list [198](#)
 custom
 access user page [650](#)
 login page [650](#)
 custom signatures [731](#)
 custom.rules file [731](#)

D

Data Encryption Standard, see DES
 date [631](#)
 daylight savings [633](#)
 DDNS [331](#)
 backup mail exchanger [336](#)
 configuration overview [98](#)
 mail exchanger [336](#)
 prerequisites [98](#)
 service providers [331](#)
 troubleshooting [731](#)
 Dead Peer Detection, see DPD
 default
 firewall behavior [374](#)
 interfaces and zones [90](#)
 login settings [741](#)
 Denial of Service (Dos) attacks [398](#)
 DES [416](#)
 device access
 troubleshooting [727](#)
 device introduction [29](#)
 DHCP [286](#), [630](#)
 and DNS servers [287](#)
 and domain name [630](#)
 and interfaces [286](#)
 client list [174](#)
 pool [287](#)
 static DHCP [287](#)
 diagnostics [705](#), [712](#)
 Diffie-Hellman key group [417](#)
 DiffServ [309](#)
 Digital Signature Algorithm public-key
 algorithm, see DSA

- direct routes [301](#)
- directory [573](#)
- directory service [573](#)
 - file structure [575](#)
- directory traversal attack [483](#)
- directory traversals [483](#)
- disclaimer [5](#), [935](#)
- Distinguished Name (DN) [576](#), [577](#), [579](#), [580](#)
- distributed port scans [480](#)
- DN [576](#), [577](#), [579](#), [580](#)
- DNS [256](#), [636](#)
 - address records [640](#)
 - domain name forwarders [641](#)
 - domain name to IP address [640](#)
 - IP address to domain name [640](#)
 - Mail eXchange (MX) records [642](#)
 - pointer (PTR) records [640](#)
- DNS Blacklist see DNSBL [523](#)
- DNS servers [74](#), [637](#), [641](#)
 - and interfaces [287](#)
- DNSBL [523](#), [527](#), [532](#)
 - see also anti-spam [523](#)
- documentation
 - related [3](#)
- domain name [630](#)
- Domain Name System, see DNS
- double-encoding attack [484](#)
- DPD [414](#)
- DSA [596](#)
- DSCP [302](#), [304](#), [718](#)
- Dynamic Domain Name System, see DDNS
- Dynamic Host Configuration Protocol, see DHCP.
- dynamic peers in IPSec [398](#)
- dynamic WEP key exchange [811](#)
- DynDNS [331](#)
- DynDNS see also DDNS [331](#)
- Dynu [331](#)

E

- EAP Authentication [810](#)
- EGP (Exterior Gateway Protocol) [479](#)
- egress bandwidth [245](#)

- e-mail [521](#)
 - daily statistics report [680](#)
 - header buffer [523](#)
 - headers [522](#)
- Encapsulating Security Payload, see ESP
- encapsulation
 - and active protocol [422](#)
 - IPSec [399](#)
 - transport mode [422](#)
 - tunnel mode [422](#)
 - VPN [422](#)
- encryption [812](#)
 - IPSec [400](#)
 - RSA [600](#)
 - WEP [259](#)
- encryption algorithms [416](#)
 - 3DES [416](#)
 - AES [416](#)
 - and active protocol [416](#)
 - DES [416](#)
- encryption method [613](#)
- end-point control [621](#)
- end-point security [621](#)
 - multiple [622](#)
 - multiple objects [366](#)
 - SSL policy [622](#)
 - summary [623](#)
- endpoint security object
 - where used [104](#)
- enforcing policies in IPSec [399](#)
- EPC (End Point Control), see also end-point security [626](#)
- ESP [399](#), [421](#)
 - and transport mode [422](#)
- ESS [804](#)
- ESSID [254](#)
- Ethernet interfaces [107](#), [218](#)
 - and OSPF [224](#)
 - and RIP [223](#)
 - and routing protocols [222](#)
 - basic characteristics [219](#)
- examples (tutorials) [107](#)
- exceptional services [368](#)
- experimental-options attack [485](#)
- extended authentication
 - and VPN gateways [394](#)
 - IKE SA [420](#)

Extended Service Set IDentification. See
ESSID.

Extended Service Set, See ESS [804](#)

ext-user

troubleshooting [735](#)

F

false negatives [472](#)

false positives [472, 474](#)

FCC interference statement [935](#)

feature specifications [742](#)

features overview [37](#)

file extensions

configuration files [693](#)

shell scripts [693](#)

file manager [693](#)

configuration overview [106](#)

filter, MAC address [262](#)

filtered port scan [480](#)

Firefox [43](#)

firewall [374](#)

actions [386](#)

and address groups [370, 386](#)

and address objects [370, 386](#)

and ALG [351, 354](#)

and H.323 (ALG) [352](#)

and HTTP redirect [348](#)

and IPSec SA [376](#)

and IPSec VPN [733](#)

and logs [371, 386](#)

and NAT [382](#)

and port triggering [306, 731](#)

and schedules [371, 386, 462, 464](#)

and service groups [386](#)

and service objects [562](#)

and services [386](#)

and SIP (ALG) [353](#)

and user groups [386, 389](#)

and users [386, 389](#)

and VoIP pass through [354](#)

and zones [374, 384](#)

asymmetrical routes [381, 383](#)

configuration overview [100](#)

global rules [375](#)

prerequisites [100](#)

priority [384](#)

rule criteria [375](#)

see also to-ZyWALL firewall [374](#)

session limits [376, 386](#)

to-ZyWALL, see to-ZyWALL firewall

triangle routes [381, 383](#)

troubleshooting [728](#)

firmware

and restart [701](#)

boot module, see boot module

current version [168, 701](#)

getting updated [701](#)

uploading [700, 701](#)

uploading with FTP [668](#)

firmware upload

troubleshooting [737](#)

flash usage [169](#)

flood detection [481](#)

force user authentication policies

prerequisites [104](#)

forcing login [366](#)

FQDN [640](#)

fragmentation threshold [807](#)

FTP [668](#)

additional signaling port [357](#)

ALG [351](#)

and address groups [670](#)

and address objects [670](#)

and certificates [669](#)

and zones [670](#)

signaling port [356](#)

with Transport Layer Security (TLS) [669](#)

full tunnel mode [40, 427, 432](#)

Fully-Qualified Domain Name, see FQDN

G

gateway policy, see VPN gateways

Generic Routing Encapsulation, see GRE.

global SSL setting [433](#)

user portal logo [434](#)

GRE [288](#)

GSM [244](#)

Guide

CLI Reference [3](#)

Quick Start [3](#)

H

H.323 [132](#), [358](#)

additional signaling port [356](#)

ALG [351](#), [358](#)

and firewall [352](#)

and RTP [358](#)

signaling port [356](#)

hidden node [805](#)

HSDPA [244](#)

HTTP

inspection [475](#), [483](#)

over SSL, see HTTPS

redirect to HTTPS [648](#)

vs HTTPS [646](#)

HTTP redirect [347](#)

and firewall [348](#)

and interfaces [350](#)

and policy routes [348](#)

configuration overview [99](#)

packet flow [348](#)

prerequisites [99](#)

troubleshooting [732](#)

HTTPS [130](#), [645](#)

and certificates [645](#)

authenticating clients [645](#)

avoiding warning messages [655](#)

example [654](#)

vs HTTP [646](#)

with Internet Explorer [654](#)

with Netscape Navigator [655](#)

HyperText Transfer Protocol over Secure Socket Layer, see HTTPS

I

IBSS [803](#)

ICMP [562](#)

datagram length [486](#)

decoder [475](#), [483](#)

echo [481](#)

flood attack [481](#)

portsweep [480](#)

Time Stamp header length [486](#)

unreachables [480](#)

identifying

legitimate e-mail [521](#)

spam [522](#)

IEEE 802.11g [807](#)

IEEE 802.1q VLAN

IGP (Interior Gateway Protocol) [479](#)

IIS

backslash-evasion attack [484](#)

emulation [484](#)

encoding [484](#)

server [483](#)

unicode [484](#)

unicode-codepoint-encoding attack [484](#)

IKE SA

aggressive mode [415](#), [419](#)

and certificates [421](#)

and RADIUS [420](#)

and to-ZyWALL firewall [733](#)

authentication algorithms [415](#), [416](#)

content [418](#)

Dead Peer Detection (DPD) [414](#)

Diffie-Hellman key group [417](#)

encryption algorithms [416](#)

extended authentication [420](#)

ID type [418](#)

IP address, remote IPSec router [415](#)

IP address, ZyXEL device [415](#)

local identity [418](#)

main mode [415](#), [419](#)

NAT traversal [420](#)

negotiation mode [415](#)

password [420](#)

peer identity [418](#)

pre-shared key [417](#)

proposal [415](#)

see also VPN

user name [420](#)

IMAP [522](#)

incoming bandwidth [245](#)

Independent Basic Service Set

See IBSS [803](#)

ingress bandwidth [245](#)

initialization vector (IV) [813](#)

inline profile [472](#)

interface

status [170](#), [181](#)

- troubleshooting [729](#)
- types [89](#)
- interfaces [88](#), [107](#), [217](#)
 - and DNS servers [287](#)
 - and HTTP redirect [350](#)
 - and layer-3 virtualization [218](#)
 - and NAT [341](#)
 - and physical ports [88](#), [218](#)
 - and policy routes [305](#)
 - and static routes [309](#)
 - and VPN gateways [394](#)
 - and zones [88](#), [218](#)
 - as DHCP relays [286](#)
 - as DHCP servers [286](#), [630](#)
 - backup, see trunks
 - bandwidth management [285](#), [295](#)
 - bridge, see also bridge interfaces.
 - cellular [218](#)
 - configuration overview [96](#)
 - default configuration [90](#)
 - DHCP clients [285](#)
 - Ethernet, see also Ethernet interfaces.
 - gateway [285](#)
 - general characteristics [218](#)
 - IP address [284](#)
 - metric [285](#)
 - MTU [286](#)
 - overlapping IP address and subnet mask [285](#)
 - port groups, see also port groups.
 - PPPoE/PPTP, see also PPPoE/PPTP interfaces.
 - prerequisites [96](#), [219](#)
 - relationships between [219](#)
 - static DHCP [287](#)
 - subnet mask [284](#)
 - trunks, see also trunks.
 - types [218](#)
 - virtual, see also virtual interfaces.
 - VLAN, see also VLAN interfaces.
 - where used [96](#)
 - WLAN [218](#)
- Internet access
 - troubleshooting [728](#), [734](#)
- Internet Control Message Protocol, see ICMP
- Internet Explorer [43](#)
- Internet Message Access Protocol, see IMAP [522](#)
- Internet Protocol Security, see IPSec
- IP alias, see virtual interfaces
- IP decoy portscan [480](#)
- IP distributed portscan [480](#)
- IP policy routing, see policy routes
- IP pool [432](#)
- IP portscan [479](#)
- IP portsweep [480](#)
- IP protocols [561](#)
 - and service objects [562](#)
 - ICMP, see ICMP
 - TCP, see TCP
 - UDP, see UDP
- IP static routes, see static routes
- IP/MAC binding [359](#)
 - exempt list [363](#)
 - monitor [189](#)
 - static DHCP [362](#)
- IPSec [391](#)
 - active protocol [399](#)
 - AH [399](#)
 - and certificates [394](#)
 - authentication [400](#)
 - basic troubleshooting [732](#)
 - certificates [410](#)
 - connections [394](#)
 - connectivity check [400](#)
 - encapsulation [399](#)
 - encryption [400](#)
 - ESP [399](#)
 - established in two phases [392](#)
 - local network [391](#)
 - local policy [399](#)
 - manual key [399](#)
 - NetBIOS [398](#)
 - peer [391](#)
 - Perfect Forward Secrecy [400](#)
 - PFS [400](#)
 - phase 2 settings [399](#)
 - policy enforcement [399](#)
 - remote access [398](#)
 - remote IPSec router [391](#)
 - remote network [391](#)
 - remote policy [399](#)
 - replay detection [398](#)
 - SA life time [399](#)
 - SA monitor [196](#)
 - SA see also IPSec SA [421](#)
 - see also VPN
 - site-to-site with dynamic peer [398](#)
 - static site-to-site [398](#)

- transport encapsulation [399](#)
 - tunnel encapsulation [399](#)
 - VPN gateway [394](#)
 - IPSec SA
 - active protocol [421](#)
 - and firewall [376](#), [733](#)
 - and to-ZyWALL firewall [733](#)
 - authentication algorithms [415](#), [416](#)
 - authentication key (manual keys) [423](#)
 - destination NAT for inbound traffic [425](#)
 - encapsulation [422](#)
 - encryption algorithms [416](#)
 - encryption key (manual keys) [423](#)
 - local policy [421](#)
 - manual keys [423](#)
 - NAT for inbound traffic [424](#)
 - NAT for outbound traffic [424](#)
 - Perfect Forward Secrecy (PFS) [422](#)
 - proposal [422](#)
 - remote policy [421](#)
 - search by name [197](#)
 - search by policy [197](#)
 - Security Parameter Index (SPI) (manual keys) [423](#)
 - see also IPSec
 - see also VPN
 - source NAT for inbound traffic [425](#)
 - source NAT for outbound traffic [424](#)
 - status [196](#)
 - transport mode [422](#)
 - tunnel mode [422](#)
 - when IKE SA is disconnected [421](#)
 - IPSec VPN
 - configuration overview [101](#)
 - prerequisites [100](#), [101](#)
 - see also IPSec
 - troubleshooting [732](#)
 - tutorial [116](#)
 - where used [101](#)
 - ISP account
 - CHAP [613](#)
 - CHAP/PAP [613](#)
 - MPPE [613](#)
 - MSCHAP [613](#)
 - MSCHAP-V2 [613](#)
 - PAP [613](#)
 - ISP accounts [611](#)
 - and PPPoE/PPTP interfaces [233](#), [611](#)
 - authentication type [613](#)
 - encryption method [613](#)
 - stac compression [614](#)
- ## J
- Java [510](#)
 - permissions [43](#)
 - JavaScripts [43](#)
- ## K
- key pairs [589](#)
- ## L
- LAND attack [482](#)
 - lastgood.conf [696](#), [700](#)
 - LDAP [573](#)
 - and users [540](#)
 - Base DN [576](#)
 - Bind DN [576](#), [579](#)
 - directory [573](#)
 - directory structure [575](#)
 - Distinguished Name, see DN
 - DN [576](#), [577](#), [579](#), [580](#)
 - password [579](#)
 - port [578](#), [581](#)
 - search time limit [579](#)
 - SSL [579](#)
 - user attributes [553](#)
 - least load first load balancing [290](#)
 - LED troubleshooting [727](#)
 - legitimate e-mail [521](#)
 - license
 - key [215](#)
 - upgrading [215](#)
 - licensing [211](#)
 - Lightweight Directory Access Protocol, see LDAP
 - load balancing [289](#)
 - algorithms [290](#), [294](#)
 - least load first [290](#)
 - round robin [295](#)

- see also trunks [289](#)
 - session-oriented [290](#)
 - spillover [291](#)
 - tutorial [113](#)
 - weighted round robin [290](#)
 - local user database [575](#)
 - log
 - troubleshooting [737](#)
 - log messages
 - categories [686](#), [689](#), [690](#), [691](#)
 - debugging [207](#)
 - regular [207](#)
 - types of [207](#)
 - log options [526](#)
 - logged in users [175](#)
 - login
 - custom page [650](#)
 - default settings [741](#)
 - SSL user [438](#)
 - logo
 - troubleshooting [736](#)
 - logo in SSL [434](#)
 - logout
 - SSL user [444](#)
 - Web Configurator [46](#)
 - logs
 - and firewall [371](#), [386](#)
 - configuration overview [105](#)
 - descriptions [747](#)
 - e-mail profiles [681](#)
 - e-mailing log messages [208](#), [685](#)
 - formats [683](#)
 - log consolidation [686](#)
 - settings [681](#)
 - syslog servers [681](#)
 - system [681](#)
 - types of [681](#)
- ## M
- MAC address
 - and VLAN [264](#)
 - Ethernet interface [227](#)
 - filter [262](#)
 - range [168](#)
 - mail sessions threshold [524](#)
 - malware [499](#)
 - managed web pages [498](#)
 - management access
 - troubleshooting [736](#)
 - Management Information Base (MIB) [671](#), [672](#)
 - manual key IPsec [399](#)
 - MD5 [416](#)
 - memory usage [169](#), [172](#)
 - message bar [52](#)
 - Message Digest 5, see MD5
 - Message Integrity Check (MIC) [812](#)
 - messages
 - CLI [54](#)
 - warning [52](#)
 - metrics, see reports
 - Microsoft
 - Challenge-Handshake Authentication Protocol (MSCHAP) [613](#)
 - Challenge-Handshake Authentication Protocol Version 2 (MSCHAP-V2) [613](#)
 - Point-to-Point Encryption (MPPE) [613](#)
 - model name [168](#)
 - monitor [198](#)
 - SA [196](#)
 - monitor profile
 - ADP [472](#)
 - mounting
 - wall [29](#)
 - MPPE (Microsoft Point-to-Point Encryption) [613](#)
 - MSCHAP (Microsoft Challenge-Handshake Authentication Protocol) [613](#)
 - MSCHAP-V2 (Microsoft Challenge-Handshake Authentication Protocol Version 2) [613](#)
 - MTU [245](#)
 - multiple slash encoding [484](#)
 - multi-slash-encoding attack [484](#)
 - My Certificates, see also certificates [593](#)
 - myZyXEL.com [211](#)
 - accounts, creating [211](#)
- ## N
- NAT [309](#), [337](#)
 - address mapping, see policy routes
 - ALG, see ALG

- and address objects [306](#)
 - and address objects (HOST) [341](#)
 - and ALG [352](#), [354](#)
 - and firewall [382](#)
 - and interfaces [341](#)
 - and policy routes [298](#), [305](#)
 - and to-ZyWALL firewall [343](#)
 - and VoIP pass through [354](#)
 - and VPN [419](#)
 - and VPN, see also VPN
 - configuration overview [98](#)
 - limitations [310](#)
 - loopback [343](#)
 - port forwarding, see NAT
 - port translation, see NAT
 - port triggering [310](#)
 - port triggering, see also policy routes
 - prerequisites [99](#)
 - traversal [420](#)
 - trigger port, see also policy routes
 - tutorial [136](#), [139](#)
- NBNS** [230](#), [256](#), [271](#), [281](#), [287](#), [432](#)
- NetBIOS**
- Broadcast over IPsec [398](#)
 - Name Server, see NBNS.
- NetBIOS Name Server, see NBNS
- NetMeeting** [358](#)
- see also H.323
- Netscape Navigator** [43](#)
- network access mode** [39](#)
- full tunnel [40](#), [427](#)
- Network Address Translation**, see NAT
- network list**, see SSL [432](#)
- network policy**, see VPN connections
- Network Time Protocol (NTP)** [634](#)
- Nmap** [479](#)
- No-IP** [331](#)
- non-RFC**
- characters [484](#)
 - defined-char attack [484](#)
 - HTTP-delimiter attack [484](#)
- NSSA** [316](#)
- O**
- object
- end-point security [621](#)
 - object-based configuration [87](#)
 - objects [87](#), [103](#), [428](#)
 - AAA server [573](#)
 - addresses and address groups [555](#)
 - authentication method [583](#)
 - certificates [589](#)
 - for configuration [87](#)
 - introduction to [87](#)
 - schedules [567](#)
 - services and service groups [561](#)
 - SSL application [615](#)
 - users, user groups [539](#)
 - obsolete-options attack [485](#)
 - One-Time Password (OTP) [574](#)
 - Online Certificate Status Protocol (OCSP) [609](#)
 - vs CRL [609](#)
 - Open Shortest Path First, see OSPF
 - order of feature application [91](#)
 - OSPF** [315](#)
 - and Ethernet interfaces [224](#)
 - and RIP [318](#)
 - and static routes [318](#)
 - and to-ZyWALL firewall [316](#)
 - area 0 [317](#)
 - areas, see OSPF areas
 - authentication method [224](#)
 - autonomous system (AS) [315](#)
 - backbone [317](#)
 - configuration steps [319](#)
 - direction [224](#)
 - link cost [224](#)
 - priority [224](#)
 - redistribute [318](#)
 - redistribute type (cost) [320](#), [321](#)
 - routers, see OSPF routers
 - virtual links [318](#)
 - vs RIP [313](#), [315](#)
 - OSPF areas** [316](#)
 - and Ethernet interfaces [224](#)
 - backbone [316](#)
 - Not So Stubby Area (NSSA) [316](#)
 - stub areas [316](#)
 - types of [316](#)
 - OSPF routers** [317](#)
 - area border (ABR) [317](#)
 - autonomous system boundary (ASBR) [318](#)
 - backbone (BR) [318](#)

- backup designated (BDR) [318](#)
 - designated (DR) [318](#)
 - internal (IR) [317](#)
 - link state advertisements
 - priority [318](#)
 - types of [317](#)
 - other documentation [3](#)
 - OTP (One-Time Password) [574](#)
 - outgoing bandwidth [245](#)
 - oversize
 - chunk-encoding attack [484](#)
 - len attack [485](#)
 - offset attack [485](#)
 - request-uri-directory attack [484](#)
- ## P
- packet
 - flow [91](#)
 - statistics [178](#), [180](#)
 - packet capture [707](#)
 - example [711](#)
 - files [706](#), [710](#), [713](#), [714](#)
 - troubleshooting [738](#)
 - packet captures
 - downloading files [707](#), [711](#), [713](#), [714](#)
 - Pairwise Master Key (PMK) [813](#), [815](#)
 - PAP (Password Authentication Protocol) [613](#)
 - Password Authentication Protocol (PAP) [613](#)
 - Peanut Hull [331](#)
 - Peer-to-peer (P2P)
 - calls [132](#), [353](#)
 - Perfect Forward Secrecy (PFS) [400](#)
 - Diffie-Hellman key group [422](#)
 - performance
 - troubleshooting [731](#)
 - Personal Identification Number code, see PIN code
 - PFS (Perfect Forward Secrecy) [400](#), [422](#)
 - phishing [499](#)
 - physical ports
 - and interfaces [88](#)
 - packet statistics [178](#), [180](#)
 - PIN code [244](#)
 - PIN generator [574](#)
 - pointer record [640](#)
 - Point-to-Point Protocol over Ethernet, see PPPoE.
 - Point-to-Point Tunneling Protocol, see PPTP
 - policy enforcement in IPSec [399](#)
 - policy route
 - troubleshooting [728](#)
 - policy routes [298](#)
 - actions [300](#)
 - and address objects [304](#)
 - and ALG [353](#), [354](#), [357](#)
 - and HTTP redirect [348](#)
 - and interfaces [305](#)
 - and NAT [298](#)
 - and schedules [304](#), [462](#), [464](#)
 - and service objects [562](#)
 - and trunks [290](#), [305](#)
 - and user groups [303](#), [304](#), [462](#), [464](#)
 - and users [303](#), [304](#), [462](#), [464](#)
 - and VoIP pass through [353](#), [354](#)
 - and VPN connections [305](#), [733](#)
 - bandwidth management [307](#)
 - benefits [298](#)
 - BWM [301](#)
 - configuration overview [96](#)
 - criteria [300](#)
 - overriding direct routes [301](#)
 - prerequisites [97](#)
 - POP
 - POP2 [522](#)
 - POP3 [522](#)
 - pop-up windows [43](#)
 - port forwarding, see NAT
 - port groups [107](#), [218](#), [221](#)
 - port roles [220](#)
 - and Ethernet interfaces [220](#)
 - and physical ports [220](#)
 - port scan, filtered [480](#)
 - port scanning [479](#)
 - port sweep [480](#)
 - port translation, see NAT
 - port triggering [310](#)
 - and firewall [306](#), [731](#)
 - and policy routes [306](#)
 - and service groups [306](#)
 - and services [306](#)
 - troubleshooting [731](#)

- Post Office Protocol, see POP [522](#)
 - power off [35](#), [725](#)
 - power on [34](#)
 - PPP [288](#)
 - troubleshooting [729](#)
 - PPP interfaces
 - subnet mask [284](#)
 - PPPoE [288](#)
 - and RADIUS [288](#)
 - TCP port 1723 [288](#)
 - PPPoE/PPTP interfaces [218](#), [233](#)
 - and ISP accounts [233](#), [611](#)
 - basic characteristics [219](#)
 - gateway [233](#)
 - subnet mask [233](#)
 - PPTP [288](#)
 - and GRE [288](#)
 - as VPN [288](#)
 - preamble mode [807](#)
 - privacy concerns [500](#)
 - problems [727](#)
 - product
 - overview [29](#)
 - registration [938](#)
 - protocol anomaly [468](#), [483](#)
 - detection [475](#)
 - proxy servers [348](#)
 - web, see web proxy servers
 - PSK [813](#)
 - PTR record [640](#)
 - public server tutorial [136](#), [139](#)
 - Public-Key Infrastructure (PKI) [590](#)
 - public-private key pairs [589](#)
 - and IKE SA [420](#)
 - and PPPoE [288](#)
 - and users [540](#)
 - message types [809](#)
 - messages [809](#)
 - shared secret key [810](#)
 - user attributes [553](#)
- R**
- RADIUS server
 - troubleshooting [735](#)
 - RDP [616](#)
 - Real-time Transport Protocol, see RTP
 - RealVNC [616](#)
 - reauthentication time [260](#), [262](#)
 - reboot [34](#), [106](#), [723](#)
 - vs reset [723](#)
 - Reference Guide, CLI [3](#)
 - registration [211](#)
 - and content filtering [492](#), [494](#), [497](#)
 - configuration overview [96](#)
 - prerequisites [96](#)
 - product [938](#)
 - subscription services, see subscription services
 - related documentation [3](#)
 - Relative Distinguished Name (RDN) [576](#), [577](#), [579](#), [580](#)
 - remote access IPsec [398](#)
 - Remote Authentication Dial-In User Service, see RADIUS
 - remote desktop connections [616](#)
 - Remote Desktop Protocol
 - see RDP
 - remote management
 - CNM [675](#)
 - configuration overview [105](#)
 - FTP, see FTP
 - prerequisites [105](#)
 - see also service control [644](#)
 - Telnet [666](#)
 - to-ZyWALL firewall [375](#)
 - WWW, see WWW
 - remote network [391](#)
 - remote user screen links [615](#)
 - replay detection [398](#)
 - reports
 - anti-spam [204](#)
 - collecting data [184](#)

configuration overview [105](#)
 content filtering [200](#)
 daily [680](#)
 daily e-mail [680](#)
 specifications [186](#)
 traffic statistics [183](#)
 reset [738](#)
 vs reboot [723](#)
 RESET button [34](#), [738](#)
 RFC
 1058 (RIP) [314](#)
 1389 (RIP) [314](#)
 1587 (OSPF areas) [316](#)
 1631 (NAT) [309](#)
 1889 (RTP) [358](#)
 2131 (DHCP) [286](#)
 2132 (DHCP) [286](#)
 2328 (OSPF) [315](#)
 2402 (AH) [399](#), [421](#)
 2406 (ESP) [399](#), [421](#)
 2510 (Certificate Management Protocol or
 CMP) [597](#)
 2516 (PPPoE) [288](#)
 2637 (PPTP) [288](#)
 2890 (GRE) [288](#)
 3261 (SIP) [358](#)
 RIP [314](#)
 and Ethernet interfaces [223](#)
 and OSPF [314](#)
 and static routes [314](#)
 and to-ZyWALL firewall [314](#)
 authentication [314](#)
 direction [224](#)
 redistribute [314](#)
 RIP-2 broadcasting methods [224](#)
 versions [224](#)
 vs OSPF [313](#)
 Rivest, Shamir and Adleman public-key
 algorithm (RSA) [596](#)
 round robin [295](#)
 routing
 troubleshooting [731](#)
 Routing Information Protocol, see RIP
 routing protocols [313](#)
 and authentication algorithms [325](#)
 and Ethernet interfaces [222](#)
 RSA [596](#), [600](#), [607](#)
 RTP [358](#)

 see also ALG [358](#)
 RTS (Request To Send) [806](#)
 threshold [805](#), [807](#)

S

safety warnings [8](#)
 SCEP (Simple Certificate Enrollment Protocol)
 [597](#)
 schedule
 troubleshooting [735](#)
 schedules [567](#)
 and content filtering [487](#), [488](#)
 and current date/time [567](#)
 and firewall [371](#), [386](#), [462](#), [464](#)
 and policy routes [304](#), [462](#), [464](#)
 one-time [567](#)
 recurring [567](#)
 types of [567](#)
 where used [104](#)
 screen resolution [43](#)
 SecuExtender [449](#)
 Secure Hash Algorithm, see SHA1
 Secure Socket Layer, see SSL
 security associations, see IPsec
 security settings
 troubleshooting [728](#)
 self-directory-traversal attack [484](#)
 self-referential directories [484](#)
 sensitivity level [474](#)
 serial number [168](#)
 service control [129](#), [644](#)
 and to-ZyWALL firewall [644](#)
 and users [645](#)
 limitations [644](#)
 timeouts [645](#)
 service groups [562](#)
 and firewall [386](#)
 and port triggering [306](#)
 where used [104](#)
 service objects [561](#)
 and firewall [562](#)
 and IP protocols [562](#)
 and policy routes [562](#)
 service set [254](#)

- Service Set IDentity, See SSID. [249](#), [251](#)
- service subscription status [215](#)
- services [561](#), [799](#)
 - and firewall [386](#)
 - and port triggering [306](#)
 - subscription [212](#)
 - where used [104](#)
- Session Initiation Protocol, see SIP
- session limits [376](#), [386](#)
- sessions [186](#)
- sessions usage [169](#), [173](#)
- SHA1 [416](#)
- shell script
 - troubleshooting [737](#)
- shell scripts [693](#)
 - and users [553](#)
 - downloading [703](#)
 - editing [702](#)
 - how applied [694](#)
 - managing [702](#)
 - not stopping or starting the ZyWALL [35](#)
 - syntax [694](#)
 - uploading [704](#)
- shutdown [35](#), [725](#)
- signal quality [194](#), [195](#)
- SIM card [244](#)
- Simple Certificate Enrollment Protocol (SCEP) [597](#)
- Simple Mail Transfer Protocol, see SMTP [522](#)
- Simple Network Management Protocol, see SNMP
- Simple Traversal of UDP through NAT, see STUN
- SIP [352](#), [358](#)
 - ALG [351](#)
 - and firewall [353](#)
 - and RTP [358](#)
 - media inactivity timeout [356](#)
 - signaling inactivity timeout [356](#)
 - signaling port [356](#)
- SMTP [522](#)
- smurf attack [481](#)
- SNAT [309](#)
 - troubleshooting [731](#)
- SNMP [670](#), [671](#)
 - agents [671](#)
 - and address groups [674](#)
 - and address objects [674](#)
 - and zones [674](#)
 - Get [671](#)
 - GetNext [672](#)
 - Manager [671](#)
 - managers [671](#)
 - MIB [671](#), [672](#)
 - network components [671](#)
 - Set [672](#)
 - Trap [672](#)
 - traps [672](#)
 - versions [670](#)
- Source Network Address Translation, see SNAT
- spam [521](#)
- specifications [741](#)
 - device [741](#)
 - feature [742](#)
 - hardware [741](#)
- spillover (for load balancing) [291](#)
- spyware [499](#)
- SSH [661](#)
 - and address groups [665](#)
 - and address objects [665](#)
 - and certificates [664](#)
 - and zones [665](#)
 - client requirements [663](#)
 - encryption methods [663](#)
 - for secure Telnet [665](#)
 - how connection is established [662](#)
 - versions [663](#)
 - with Linux [666](#)
 - with Microsoft Windows [665](#)
- SSID [249](#), [251](#)
- SSL [427](#), [432](#), [645](#)
 - access policy [427](#)
 - and AAA [579](#)
 - and AD [579](#)
 - and LDAP [579](#)
 - certificates [438](#)
 - client [449](#)
 - client virtual desktop logo [434](#)
 - computer names [432](#)
 - connection monitor [198](#)
 - full tunnel mode [432](#)
 - global setting [433](#)
 - IP pool [432](#)
 - network list [432](#)
 - remote user login [438](#)
 - remote user logout [444](#)

- SecuExtender [449](#)
 - see also SSL VPN [427](#)
 - troubleshooting [734](#)
 - user application screens [447](#)
 - user screen bookmarks [444](#)
 - user screens [437](#), [443](#)
 - user screens access methods [437](#)
 - user screens certificates [438](#)
 - user screens login [438](#)
 - user screens logout [444](#)
 - user screens required information [438](#)
 - user screens system requirements [438](#)
 - WINS [432](#)
 - SSL application object [615](#)
 - remote user screen links [615](#)
 - summary [617](#)
 - types [615](#)
 - web-based [615](#), [618](#)
 - web-based example [616](#)
 - where used [104](#)
 - SSL policy
 - add [430](#)
 - edit [430](#)
 - objects used [428](#)
 - SSL VPN [427](#)
 - access policy [427](#)
 - configuration overview [101](#)
 - full tunnel mode [40](#), [427](#)
 - network access mode [39](#)
 - prerequisites [101](#)
 - remote desktop connections [616](#)
 - see also SSL [427](#)
 - troubleshooting [734](#)
 - weblink [616](#)
 - where used [101](#)
 - stac compression [614](#)
 - starting the ZyWALL [34](#), [35](#)
 - startup-config.conf [700](#)
 - if errors [696](#)
 - missing at restart [696](#)
 - present at restart [696](#)
 - startup-config-bad.conf [696](#)
 - static DHCP [362](#)
 - static routes [298](#)
 - and interfaces [309](#)
 - and OSPF [318](#)
 - and RIP [314](#)
 - configuration overview [98](#)
 - metric [309](#)
 - prerequisites [98](#)
 - statistics
 - anti-spam [204](#)
 - content filtering [200](#)
 - daily e-mail report [680](#)
 - traffic [183](#)
 - status [165](#)
 - status bar [52](#)
 - warning message popup [52](#)
 - stopping the ZyWALL [34](#), [35](#)
 - stub area [316](#)
 - STUN [353](#)
 - and ALG [353](#)
 - subscription services [212](#)
 - content filtering [213](#)
 - SSL VPN [212](#)
 - SSL VPN, see also SSL VPN
 - status [215](#)
 - upgrading [215](#)
 - supported browsers [43](#)
 - SWM [301](#)
 - SYN flood [482](#)
 - syntax conventions [6](#)
 - syslog [683](#), [689](#)
 - syslog servers, see also logs
 - system log, see logs
 - system name [168](#), [630](#)
 - system reports, see reports
 - system uptime [168](#)
 - system-default.conf [700](#)
- ## T
- T/TCP [485](#)
 - target market [29](#)
 - TCP [561](#)
 - ACK (acknowledgment) [481](#)
 - connections [561](#)
 - decoder [475](#), [483](#)
 - decoy portscan [480](#)
 - distributed portscan [480](#)
 - port numbers [562](#)
 - portscan [479](#)
 - portsweep [480](#)

- RST [480](#)
- SYN (synchronize) [481](#)
- SYN flood [481](#)
- technical reference [163](#)
- Telnet [666](#)
 - and address groups [668](#)
 - and address objects [668](#)
 - and zones [668](#)
 - with SSH [665](#)
- Temporal Key Integrity Protocol (TKIP) [812](#)
- terminology differences
 - with ZynOS [91](#)
- three-way handshake [482](#)
- throughput rate
 - troubleshooting [737](#)
- TightVNC [616](#)
- time [631](#)
- time servers (default) [634](#)
- token [574](#)
- to-ZyWALL firewall [375](#)
 - and NAT [343](#)
 - and NAT traversal (VPN) [733](#)
 - and OSPF [316](#)
 - and remote management [375](#)
 - and RIP [314](#)
 - and service control [644](#)
 - and VPN [733](#)
 - global rules [375](#)
 - see also firewall [374](#)
- trademarks [935](#)
- traffic anomaly [468](#), [472](#)
- traffic statistics [183](#)
- Transmission Control Protocol, see TCP
- transport encapsulation [399](#)
- Transport Layer Security (TLS) [669](#)
- triangle routes [381](#)
 - allowing through the firewall [383](#)
 - vs virtual interfaces [381](#)
- Triple Data Encryption Standard, see 3DES
- troubleshooting [705](#), [712](#), [727](#)
 - admin user [735](#)
 - bandwidth limit [730](#)
 - cellular [729](#), [730](#)
 - certificate [736](#)
 - configuration file [737](#)
 - connection resets [732](#)
 - content filter [728](#)
 - DDNS [731](#)
 - device access [727](#)
 - ext-user [735](#)
 - firewall [728](#)
 - firmware upload [737](#)
 - HTTP redirect [732](#)
 - interface [729](#)
 - Internet access [728](#), [734](#)
 - IPSec VPN [732](#)
 - LEDs [727](#)
 - logo [736](#)
 - logs [737](#)
 - management access [736](#)
 - packet capture [738](#)
 - packet flow [91](#)
 - performance [731](#)
 - policy route [728](#)
 - port triggering [731](#)
 - PPP [729](#)
 - RADIUS server [735](#)
 - routing [731](#)
 - schedules [735](#)
 - security settings [728](#)
 - shell scripts [737](#)
 - SNAT [731](#)
 - SSL [734](#)
 - SSL VPN [734](#)
 - throughput rate [737](#)
 - VLAN [730](#)
 - VPN [734](#)
 - WLAN [730](#)
- truncated-address-header attack [485](#)
- truncated-header attack [485](#), [486](#)
- truncated-options attack [485](#)
- truncated-timestamp-header attack [486](#)
- trunks [218](#), [289](#)
 - and ALG [357](#)
 - and policy routes [290](#), [305](#)
 - configuration overview [96](#)
 - member interface mode [294](#)
 - member interfaces [294](#)
 - prerequisites [96](#)
 - see also load balancing [289](#)
 - tutorial [113](#)
 - where used [96](#)
- Trusted Certificates, see also certificates [603](#)
- TTCP-detected attack [485](#)
- tunnel encapsulation [399](#)

tutorials [107](#)

U

UDP [561](#)

decoder [475, 483](#)

decoy portscan [480](#)

distributed portscan [480](#)

flood attack [483](#)

messages [561](#)

port numbers [562](#)

portscan [479](#)

portsweep [480](#)

u-encoding attack [484](#)

UltraVNC [616](#)

undersize-len attack [485](#)

undersize-offset attack [485](#)

unreachables (ICMP) [480](#)

unsafe web pages [498](#)

unsolicited commercial e-mail [521](#)

upgrading

firmware [700](#)

licenses [215](#)

uploading

configuration files [700](#)

firmware [700](#)

shell scripts [702](#)

usage

CPU [169, 171](#)

flash [169](#)

memory [169, 172](#)

onboard flash [169](#)

sessions [169, 173](#)

user accounts

for WLAN [147, 541](#)

user authentication [539](#)

external [540](#)

local user database [575](#)

user awareness [541](#)

User Datagram Protocol, see UDP

user group objects [539](#)

user groups [539, 541](#)

and content filtering [487](#)

and firewall [386, 389](#)

and policy routes [303, 304, 462, 464](#)

configuration overview [104](#)

user name

rules [542](#)

user objects [539](#)

user portal

links [615](#)

logo [434](#)

see SSL user screens [437, 443](#)

user sessions, see sessions

user SSL screens [437, 443](#)

access methods [437](#)

bookmarks [444](#)

certificates [438](#)

login [438](#)

logout [444](#)

required information [438](#)

system requirements [438](#)

User's Guide [27](#)

user-aware [120](#)

users [539](#)

access, see also access users

admin (type) [539](#)

admin, see also admin users

and AAA servers [540](#)

and authentication method objects [540](#)

and content filtering [487](#)

and firewall [386, 389](#)

and LDAP [540](#)

and policy routes [303, 304, 462, 464](#)

and RADIUS [540](#)

and service control [645](#)

and shell scripts [553](#)

attributes for Ext-User [540](#)

attributes for LDAP [553](#)

attributes for RADIUS [553](#)

attributes in AAA servers [553](#)

configuration overview [104](#)

currently logged in [169, 175](#)

default lease time [549, 551](#)

default reauthentication time [549, 551](#)

default type for Ext-User [540](#)

ext-group-user (type) [540](#)

Ext-User (type) [540](#)

ext-user (type) [540](#)

groups, see user groups

Guest (type) [540](#)

lease time [544](#)

limited-admin (type) [540](#)

- lockout [550](#)
- prerequisites for force user authentication policies [104](#)
- reauthentication time [545](#)
- types of [539](#)
- user (type) [540](#)
- user names [542](#)

UTF-8 decode [484](#)

UTF-8-encoding attack [484](#)

V

Vantage CNM [674](#)

Vantage Report (VRPT) [683](#), [689](#)

virtual interfaces [218](#)

- basic characteristics [219](#)
- not DHCP clients [285](#)
- vs asymmetrical routes [381](#)
- vs triangle routes [381](#)

Virtual Local Area Network, see VLAN.

Virtual Network Computing

- see VNC

Virtual Private Network, see VPN

VLAN [264](#)

- advantages [265](#)
- and MAC address [264](#)
- ID [264](#)
- troubleshooting [730](#)

VLAN interfaces [218](#), [265](#)

- and Ethernet interfaces [265](#), [730](#)
- basic characteristics [219](#)

VoIP [251](#)

VoIP pass through [358](#)

- and firewall [354](#)
- and NAT [354](#)
- and policy routes [353](#), [354](#)
- see also ALG [352](#)

VPN [391](#)

- active protocol [421](#)
- and NAT [419](#)
- and the firewall [376](#)
- basic troubleshooting [732](#)
- IKE SA, see IKE SA
- IPSec [391](#)
- IPSec SA
- proposal [416](#)

- security associations (SA) [392](#)
- see also IKE SA
- see also IPSec [391](#)
- see also IPSec SA
- status [174](#)
- troubleshooting [734](#)

VPN connections

- and address objects [394](#)
- and policy routes [305](#), [733](#)

VPN gateways

- and certificates [394](#)
- and extended authentication [394](#)
- and interfaces [394](#)
- and to-ZyWALL firewall [733](#)

VRPT (Vantage Report) [683](#), [689](#)

W

wall-mounting [29](#)

warm start [34](#)

warning message popup [52](#)

warranty [937](#)

- note [937](#)

Web Configurator [33](#), [43](#)

- access [43](#)
- access users [552](#)
- requirements [43](#)
- supported browsers [43](#)

web features

- ActiveX [510](#)
- cookies [510](#)
- Java [510](#)
- web proxy servers [510](#)

web proxy servers [348](#), [510](#)

- see also HTTP redirect

web site

- ZyXEL [4](#)

web-based SSL application [615](#)

- configuration example [616](#)
- create [618](#)

weblink [616](#)

webroot-directory-traversal attack [485](#)

weighted round robin (for load balancing) [290](#)

white list (anti-spam) [521](#), [527](#), [529](#), [531](#)

Wi-Fi Protected Access [812](#)

Windows Internet Naming Service, see WINS
 Windows Internet Naming Service, see WINS.
 Windows Internet Naming Service. See WINS.
 Windows Remote Desktop **616**
 WINS **230, 256, 271, 281, 287, 432**
 WINS server **230, 256**
 wireless
 clients **191**
 MAC filter **262**
 wireless client **248**
 wireless client WPA supplicants **814**
 wireless network
 channel **249**
 example **248**
 overview **248**
 security **249**
 SSID **249**
 wireless security **249, 808**
 Wizard Setup **59, 69**
 WLAN **146, 248**
 interfaces **218**
 interference **805**
 security parameters **816**
 see also wireless.
 troubleshooting **730**
 user accounts **147, 541**
 wireless client setup **150**
 WLAN station monitor **191**
 WMM **251**
 WPA **812**
 key caching **814**
 pre-authentication **814**
 user authentication **813**
 vs WPA-PSK **813**
 wireless client supplicant **814**
 with RADIUS application example **814**
 WPA2 **812**
 user authentication **813**
 vs WPA2-PSK **813**
 wireless client supplicant **814**
 with RADIUS application example **814**
 WPA2-Pre-Shared Key (WPA2-PSK) **812**
 WPA2-PSK **812, 813**
 application example **815**
 WPA-PSK **812, 813**
 application example **815**
 WWW **646**

and address groups **650**
 and address objects **650**
 and authentication method objects **649**
 and certificates **648**
 and zones **650**
 see also HTTP, HTTPS **130, 646**
 www.zyxel.com **4**

Z

zones **88, 327**
 and firewall **374, 384**
 and FTP **670**
 and interfaces **88, 327**
 and SNMP **674**
 and SSH **665**
 and Telnet **668**
 and VPN **88, 327**
 and WWW **650**
 block intra-zone traffic **330, 382**
 configuration overview **98**
 default **90**
 extra-zone traffic **328**
 inter-zone traffic **328**
 intra-zone traffic **328**
 prerequisites **98**
 types of traffic **328**
 where used **98**
 ZyWALL terminology differences **91**
 ZyXEL
 web site **4**